

# New Brunswick™ S41i

Operating manual

Copyright © 2019 Eppendorf AG, Germany. All rights reserved, including graphics and images. No part of this publication may be reproduced without the prior permission of the copyright owner.

Eppendorf® and the Eppendorf Brand Design are registered trademarks of Eppendorf AG, Germany.

BioCommand® is a registered trademark of Eppendorf, Inc., USA.

Registered trademarks and protected trademarks are not marked in all cases with ® or ™ in this manual.

## Table of contents

<b>1</b>	<b>Operating instructions</b>	<b>7</b>
1.1	Using this manual	7
1.2	Danger symbols and danger levels	7
1.2.1	Danger symbols	7
1.2.2	Danger levels	7
1.3	Symbols used	8
1.4	Abbreviations used	8
<b>2</b>	<b>Safety</b>	<b>9</b>
2.1	Intended use	9
2.2	User profile	9
2.3	Personal protective equipment	9
2.4	Information on product liability	9
2.5	Warnings for intended use	10
2.5.1	Personal injury and damage to device	10
2.6	Application limits	12
2.6.1	Description of ATEX Guideline (94/9EC)	12
2.7	Warning signs on the device	12
<b>3</b>	<b>Product description</b>	<b>13</b>
3.1	Product overview	13
3.2	Delivery Package	13
3.3	Features	14
3.4	High temperature disinfection	14
<b>4</b>	<b>Installation</b>	<b>15</b>
4.1	Inspection of Boxes	15
4.2	Selecting the location	15
4.3	Unpacking the device	16
4.4	Installation of Foot Shields	16
4.5	Removing the battery insulating strip	19
4.6	Platform Assemblies	19
4.7	Installation of Platform	20
4.8	Flask Clamp Installation	20
4.9	Stacking Instructions	22
4.10	Electrical Connections	22
4.11	Setting Up	22
4.12	Making Connections	24
4.13	Ethernet Connection	27
4.14	BMS relay contact alarm	27
4.14.1	Incubator operating, no alarm	28
4.14.2	Incubator with alarm triggered	29
<b>5</b>	<b>Operation</b>	<b>31</b>
5.1	Preparing for operation	31
5.2	Using the Water Trays	31
5.3	Starting the Incubator Shaker	32
5.4	Using the Touchscreen	32

**Table of contents**

New Brunswick™ S41i  
English (EN)

5.4.1	Initial display and STATUS screen . . . . .	32
5.4.2	Starting the platform . . . . .	34
5.4.3	Stopping the platform . . . . .	35
5.4.4	Setting the temperature . . . . .	36
5.4.5	Setting the CO <sub>2</sub> level . . . . .	36
5.4.6	Setting the shaking speed . . . . .	37
5.5	MENU 1 Screen . . . . .	38
5.5.1	HELP function . . . . .	38
5.5.2	EVENT LOG . . . . .	38
5.5.3	ALARM SETTINGS screen . . . . .	40
5.5.4	SUMMARY screen . . . . .	42
5.5.5	EVENT GRAPH screen . . . . .	43
5.5.6	SET CALIBRATION screen . . . . .	46
5.5.7	GENERAL SETTINGS screen . . . . .	48
5.5.8	USER ACCESS screen . . . . .	54
5.5.9	COMMUNICATIONS screen . . . . .	57
5.6	MENU 2 Screen . . . . .	58
5.6.1	SERVICE screen . . . . .	59
5.6.2	DIAGNOSTICS screen . . . . .	59
5.6.3	MAINTENANCE screen . . . . .	60
5.6.4	OPTIONS screen . . . . .	67
5.6.5	SET CO <sub>2</sub> AUTOZERO screen . . . . .	67
5.6.6	DISINFECTION screen . . . . .	71
<b>6</b>	<b>Troubleshooting . . . . .</b>	<b>75</b>
6.1	General errors . . . . .	75
6.2	Mains/Power Interruption and Fault Interruption . . . . .	75
<b>7</b>	<b>Maintenance . . . . .</b>	<b>77</b>
7.1	Routine Maintenance . . . . .	77
7.1.1	General notes . . . . .	77
7.1.2	Daily checks . . . . .	77
7.1.3	Weekly checks . . . . .	77
7.1.4	Monthly check . . . . .	77
7.1.5	Other checks . . . . .	77
7.1.6	CO <sub>2</sub> Sampling with Analyzer . . . . .	78
7.2	Cleaning . . . . .	78
7.3	Disinfection/Decontamination . . . . .	79
7.4	Shipping the device . . . . .	81
<b>8</b>	<b>Transport, storage and disposal . . . . .</b>	<b>83</b>
8.1	Transport . . . . .	83
8.2	Storage . . . . .	83
8.3	Disposal . . . . .	83
<b>9</b>	<b>Technical data . . . . .</b>	<b>85</b>
9.1	Weight/dimensions . . . . .	85
9.1.1	Device Dimensions . . . . .	85
9.1.2	Platform dimensions . . . . .	85
9.2	Power supply . . . . .	86

9.2.1	Mains/electrical supply . . . . .	86
9.3	Ambient operating conditions . . . . .	86
9.4	Application parameters . . . . .	86
9.4.1	Speed . . . . .	86
9.4.2	Temperature management . . . . .	87
9.4.3	CO <sub>2</sub> control . . . . .	87
9.4.4	Relative humidity . . . . .	87
9.4.5	Flasks . . . . .	88
9.4.6	Calibration . . . . .	88
<b>10</b>	<b>Ordering information . . . . .</b>	<b>89</b>
10.1	Accessories . . . . .	89
	<b>Index . . . . .</b>	<b>92</b>
	<b>Certificates . . . . .</b>	<b>93</b>



# 1 Operating instructions









## 1.1 Using this manual

- ▶ Read this operating manual completely before using the device for the first time. Observe the instructions for use of the accessories where applicable.
- ▶ This operating manual is part of the product. Please keep it in a place that is easily accessible.
- ▶ Enclose this operating manual when transferring the device to third parties.
- ▶ The current version of the operating manual for all available languages can be found on our webpage [www.eppendorf.com/manuals](http://www.eppendorf.com/manuals).

## 1.2 Danger symbols and danger levels

The safety instructions of this operating manual indicate the following danger symbols and danger levels:

### 1.2.1 Danger symbols

	Hazard point		Burns
	Electric shock		Material damage
	Explosion		Heavy loads
	Inhalation		Crush

### 1.2.2 Danger levels

<b>DANGER</b>	<i>Will</i> lead to severe injuries or death.
<b>WARNING</b>	<i>May</i> lead to severe injuries or death.
<b>CAUTION</b>	May lead to light to moderate injuries.
<b>NOTICE</b>	May lead to material damage.

### 1.3 Symbols used

Depiction	Meaning
1. 2.	Actions in the specified order
▶	Actions without a specified order
•	List
<i>Text</i>	Display or software texts
<b>i</b>	Additional information

### 1.4 Abbreviations used

**kWh**

Kilowatt hour

**LEL**

Lower Explosion Limit

**rpm**

Revolutions Per Minute

**UEL**

Upper Explosion Limit

**VA**

Volt-ampere

**VAC**

Voltage in Alternating Current



## **2 Safety**

### **2.1 Intended use**

The New Brunswick S41i incubator shaker is designed to and serve to provide stable and homogeneous atmosphere required for cell culture by controlling temperature and carbon dioxide for cultivating and shaking samples and cells from biological laboratories. The device is intended exclusively for use indoors and for operation by qualified staff for research purposes only.

### **2.2 User profile**

The device and accessories may only be operated by trained and skilled personnel.

Before using the device, read the operating manual and the instructions for use of the accessories carefully and familiarize yourself with the device's mode of operation.

### **2.3 Personal protective equipment**

Personal protective equipment protects your life and your health.

- ▶ Always wear protective clothing, protective gloves, and safety boots.
- ▶ If additional protective equipment is required, this is indicated above the respective instruction.

### **2.4 Information on product liability**

In the following cases, the designated protection of the device may be affected. The liability for any resulting damage or personal injury is then transferred to the owner:

- The device is not used in accordance with the operating manual.
- The device is used outside of its intended use.
- The device is used with accessories or consumables that are not recommended by Eppendorf.
- The device is maintained or repaired by persons not authorized by Eppendorf AG.
- The user makes unauthorized changes to the device.

## 2.5 Warnings for intended use

Before using the device, read the operating manual and observe the following general safety instructions.

### 2.5.1 Personal injury and damage to device

---



**WARNING! Risk of personal injury**

Burns due to hot surface.

- ▶ Do not touch the equipment during the high temperature disinfection cycle.
- ▶ Do not open equipment door during the cycle.



**WARNING! Risk of personal injury**

- ▶ Do not open the device!
- ▶ Do not operate a broken device! (e.g. if the exterior is damaged)
- ▶ Do not modify the device!



**CAUTION! Risk of personal injury**

- ▶ Safety standards of lab must be considered.
- ▶ Use your personal protective equipment.



**CAUTION! Risk of personal injury through infection or contamination**

- ▶ Use your personal protective equipment.
- ▶ Disinfect the device with an alcoholic solution.
- ▶ Perform the high temperature disinfection, if the device comes with this option.



**CAUTION! Risk of personal injury**

- ▶ Before closing the glass door be sure that the shelves well installed inside the chamber. Slamming the glass door against the shelf could cause broken glass and potential injury.
- ▶ Never lean on or place objects on the open door.
- ▶ Do not put your fingers between door and housing while closing the door.



**CAUTION! Lack of safety**

Lack of safety due have not enough space at the left side to disconnect the device.

- ▶ Take care to have enough space on the left side to use the disconnecting device/unplug the mains/power cord.



**CAUTION! Risk of injury when lifting and carrying heavy loads**

- ▶ Use a lifting aid for the installation of the device.



**NOTICE! Risk of material damage**

- ▶ Never put any liquid material on the top of the incubator. Spilled liquid could cause short circuit; this would cause permanent damage to the incubator.



**NOTICE! Risk of material damage**

- ▶ Never try to lift the incubator/shaker by its door; this would cause permanent damage to the incubator/shaker.



**NOTICE! Risk of material damage**

- ▶ To avoid possible damage to the CO<sub>2</sub> sensor, never leave water in the humidity trays while the incubator shaker is switched off, or when a high temperature disinfection cycle is initiated.



**NOTICE! Risk of material damage**

- ▶ To avoid possible damage to the CO<sub>2</sub> sensor, never forget to remove the cover of the sensor during the high temperature disinfection



**NOTICE! Risk of material damage**

- ▶ CO<sub>2</sub> gas pressure must not exceed 0.1 MPa (1.0 bar, 14.5 psi) at the CO<sub>2</sub> in-line pressure regulator



**NOTICE! Risk of material damage**

- ▶ Do not use any heat-generating device inside the chamber of the New Brunswick S41i device.



**NOTICE! Risk of material damage**

- ▶ Do not move the device with filled water tray.



Use distilled water only in the water tray. Use of any other types of water including deionized water and chlorinated additives will cause corrosion inside the incubator.

## 2.6 Application limits

### 2.6.1 Description of ATEX Guideline (94/9EC)



#### **DANGER! Explosion hazard**

- ▶ Do not operate the device in areas where work is completed with explosive substances.
- ▶ Do not use this device to process any explosive or highly reactive substances.
- ▶ Do not use this device to process any substances which could create an explosive atmosphere.



#### **DANGER! Explosion hazard**

- ▶ Use gases in this equipment only within the range between their lower explosion limit (LEL) and their upper explosion limit (UEL).
- ▶ If your process requires or produces gases, be sure to verify their LEL and UEL concentration range (available online or ask your gas supplier).



#### **CAUTION! Lack of safety due to incorrect use of materials**

- ▶ Do not use this device to process any flammable materials, or use materials where the transfer of mechanical energy to glass apparatus could lead to breakage.

Due to its design and the ambient conditions in its interior, the device is not suitable for use in potentially explosive atmospheres.

The device may only be used in a safe environment, e.g., the open atmosphere of a ventilated lab.

The use of substances which may contribute to a potentially explosive atmosphere is not permitted.

The final decision regarding the risks associated with using these types of substances is the user's responsibility.

## 2.7 Warning signs on the device

Symbol	Meaning	Location
	Hazard point	
	Hot surface	
	Operating manual must be read	

**3 Product description**  
**3.1 Product overview**

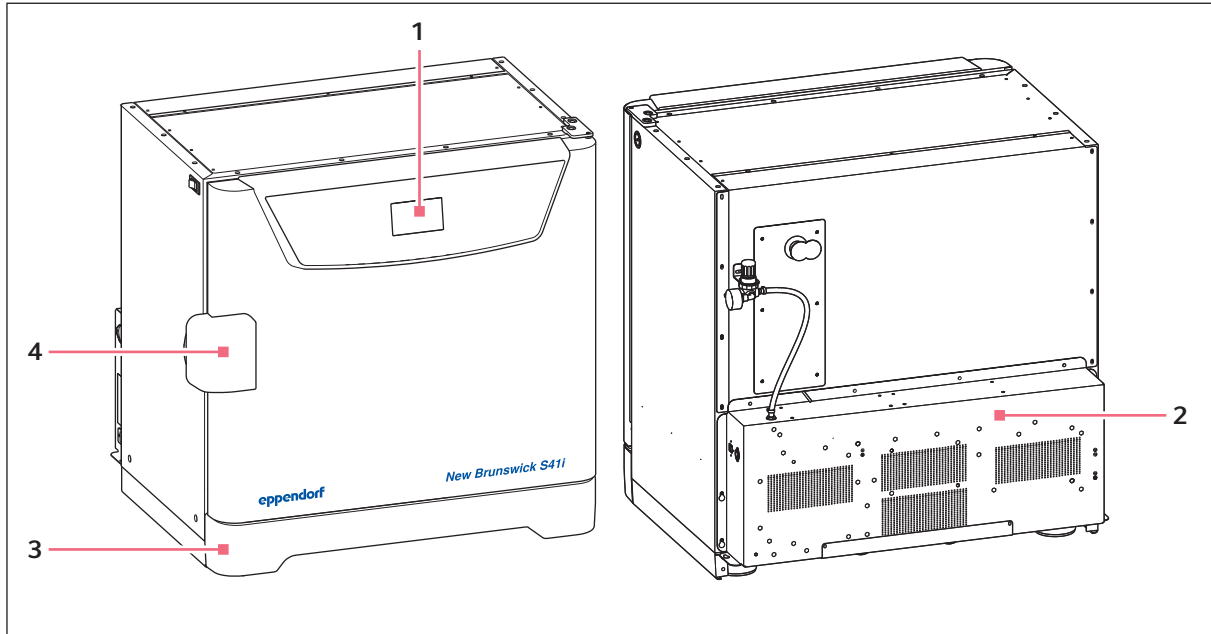

Fig. 3-1: Front and rear views

- 1 Display
- 2 Control box
- 3 Foot shield
- 4 Door handle

**3.2 Delivery Package**

**i** The operating manual and mains/power cord are shipped on top of the incubator shaker.

Quantity	Item	Notes
1	Perforated Stainless Steel Shelf	Installed
1	White porous CO <sub>2</sub> Sensor Cover	
1	Colored protective cover	
1	Front foot shield	Packed on top of incubator shaker
2	Side foot shields	
2	Humidity Trays	Packed in box on shelf
3 m (9.8 ft)	PVC Tubing, ~6 mm (1/4 in) bore, with an inline CO <sub>2</sub> HEPA-filter connected, ready for use	Packed in box on shelf
2	Hose Clips	Packed in humidity tray
1	Auto-zero HEPA Filter	

Quantity	Item	Notes
1	BMS connector	Packed in accessories bag
3	Rack spacers	
3	Rack feet	
2	Additional white porous CO <sub>2</sub> sensor cover	
1	Mains/Power Cord	Packed on top of control box at rear of incubator shaker
1	Operating Manual	

### 3.3 Features

The chamber's fanless design with 6-sided convection heating provides gentle circulation and uniform temperature. In addition, the seamless 1-piece chamber eliminates area where contaminants could collect and makes wipe-down easy.

Two water trays reduce sample evaporation.

The S41i fits on the floor, under a workbench or it can be double stacked to save space. The shaking mechanism is a heavy-duty drive with 3 eccentric drive shafts to provide stability, uniform motion and assure long incubator/shaker life. The orbit is 2.5 cm (1 in) and the shaking speed range is from 25–400 rpm ( $\pm 1$  rpm), unless 2 are stacked, in which case the maximum speed of the top incubator/shaker is limited to 250 rpm.

With no shelf present, flasks up to 4 L in size can be installed on the shaking platform. With 1 stationary shelf present, Erlenmeyer flasks up to 1 L can be installed. If 2 shelves are present, the largest size Erlenmeyer flasks must be limited to 250 mL.

A perforated stationary shelf is included to allow simultaneous incubation of adherent cultures.

The temperature range is from 4 °C above ambient temperature to 50 °C. Temperature accuracy is  $\pm 0.2$  °C through the entire range.

### 3.4 High temperature disinfection

The High Temperature Disinfection cycle on the New Brunswick S41i is designed to heat the internal chamber to 120 °C, maintain that temperature for 3.5 hours, and then allow the chamber to cool down to 37 °C or to the programmed temperature (if different from 37 °C) and the normal control will take over. The cool down to normal operating temperature will take approximately 11 hours. The total time for the HTD cycle to complete will be 14 – 15 hours dependent on the ambient conditions.

The HTD cycle is designed to disinfect all internal surfaces and components. The cycle is initiated from the touch screen display and is accessed on the Menu 2 screen; press the disinfection icon and the screen will prompt the user how to proceed (see *DISINFECT* screen on p. 71). Once the disinfection is complete the screen will alert the user; if the disinfection procedure is cancelled the screen will alert the user that this has occurred.

The event graph will track the cycle and show temperature and time and provide a visual indication that the cycle took place and was completed (see *EVENT GRAPH* screen on p. 43).

## 4 Installation

### 4.1 Inspection of Boxes

After you have received your order, inspect the boxes carefully for any damage that may have occurred during shipping. Report any damage to the carrier and to your local Eppendorf distributor immediately.

### 4.2 Selecting the location



#### **WARNING! Risk of personal injury**

- ▶ The device has to be installed on an even, stable ground to avoid falling down.



#### **CAUTION! Lack of safety due to humid storage and transport conditions**

- ▶ Device needs to be evaluated for condensation when received and unpacked for installation.
- ▶ If condensation due to storage and transport in humid conditions has occurred, allow a dry out for 4 hours in an environment of 18–25 °C and 30–80 % relative humidity. Only with a drying-out process, the device is able to meet safety requirements.



#### **NOTICE! Risk of material damage**

Due to an unlevelled device not all cells are covered with the medium; this could cause the loss of sample.

- ▶ Level the device by adjusting its feet.
- 

The New Brunswick S41i fits on the floor, under a workbench or it can be double-stacked to save space.

#### **The correct location features**

- well ventilation
- protection from direct sunlight
- protection from UV radiation
- a clear distance to heat sources, e.g. heaters or drier compartments
- a clear distance to air-conditioning ducts
- a clear distance to ultra-low temperature freezers
- a minimum ventilation clearance of 10 mm (0.5 in) all around
- enough space on the left side to use the mains/power switch and to unplug the mains/power cord

#### **The electrical connections feature**

- a matching of mains/power connection with the specifications on the name plate
- access to the mains/power switch and cutting unit of the power system circuit is accessible during operation

### 4.3 Unpacking the device

**CAUTION! Risk of injury when lifting and carrying heavy loads**

- ▶ Use a lifting aid for the installation of the device.

**NOTICE! Risk of material damage**

- ▶ Never try to lift the incubator/shaker by its door; this would cause permanent damage to the incubator/shaker.

**CAUTION! Lack of safety due to humid storage and transport conditions**

- ▶ Device needs to be evaluated for condensation when received and unpacked for installation.
- ▶ If condensation due to storage and transport in humid conditions has occurred, allow a dry out for 4 hours in an environment of 18–25 °C and 30–80 % relative humidity. Only with a drying-out process, the device is able to meet safety requirements.

- ▶ Save the packing materials.
- ▶ Save the foot shields packed on top of the incubator shaker.
- ▶ Use a mechanical lifting device to safely lift the incubator shaker off its shipping pallet and to transport it to the installation site. You may push the incubator shaker a short distance using the built-in castors to roll it. To do this, you may need to rotate the incubator shaker feet to raise them so the incubator shaker will rest on its castors.
- ▶ Remove the sleeved box on the top shelf inside the incubator shaker. The box contains the two water trays, PVC tubing and several other essential parts.
- ▶ Remove the foam blocks from the top shelf and save them.
- ▶ Remove the parts stored in the water trays.
- ▶ If any part of your order was damaged during shipping, is missing, or fails to operate, please contact your Eppendorf distributor.
- ▶ Using your packing list, verify that you have received the correct materials, and that nothing is missing.

### 4.4 Installation of Foot Shields

The front and side foot shields (see Fig. 4-1 on p. 17) are packed on top of the incubator shaker, enclosed in bubble wrap. To install them, beginning with the right side foot shield, follow this procedure:



1. Orient the mounting bracket at the front face of the incubator shaker, then align the foot shield's two keyhole slots with the two mounting pins on the bottom of the incubator shaker.

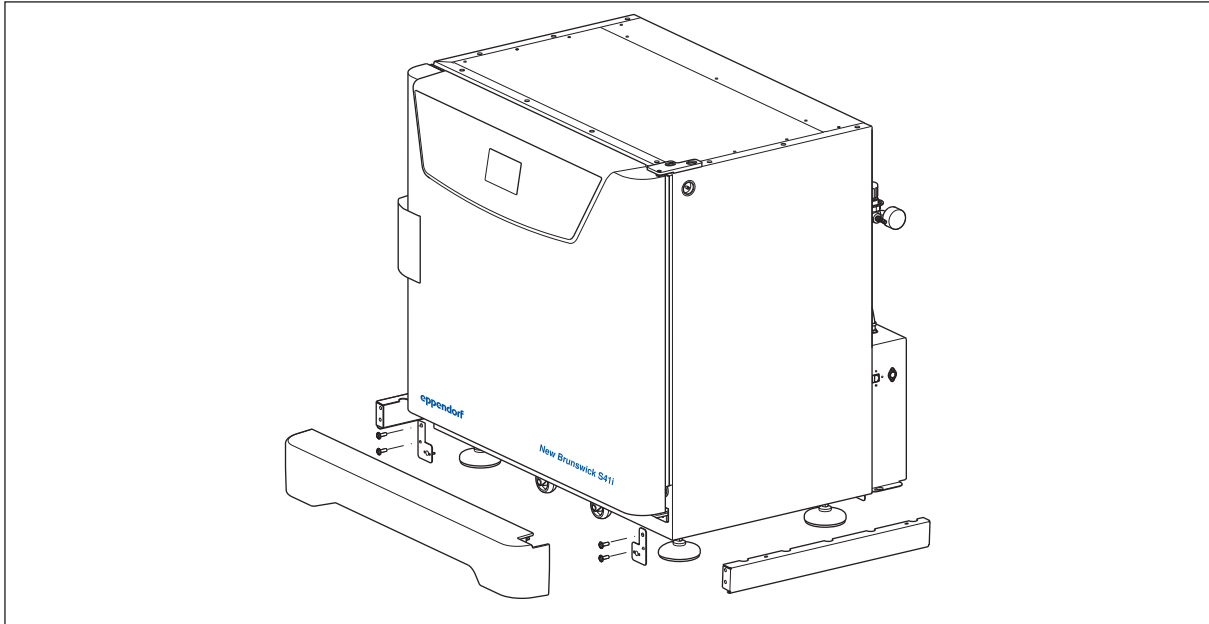

Fig. 4-1: Front and side foot shields

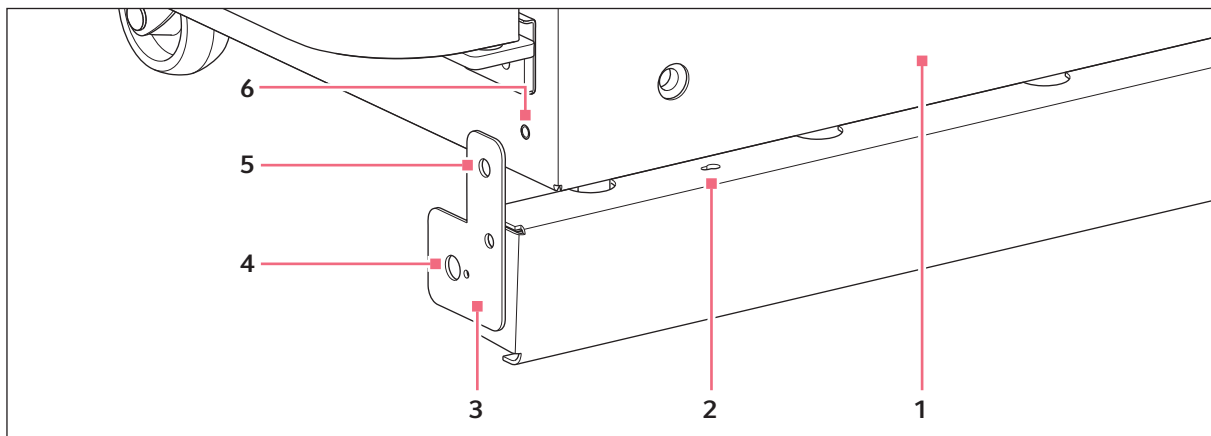

Fig. 4-2: Side foot shield installation

- |  |   |
|--|---|
| 1 Right side of incubator shaker         | 4 Hole for front foot shield's ball catch |
| 2 Keyhole slot on right side foot shield | 5 Hole for M4 screw on mounting bracket   |
| 3 Mounting bracket                       | 6 Hole for M4 screw on incubator          |

2. Snap the side shield in place, then slide it toward the back of the incubator shaker until the bracket is flush against the front face.
3. Fasten the bracket to the incubator shaker with one M4 screw:

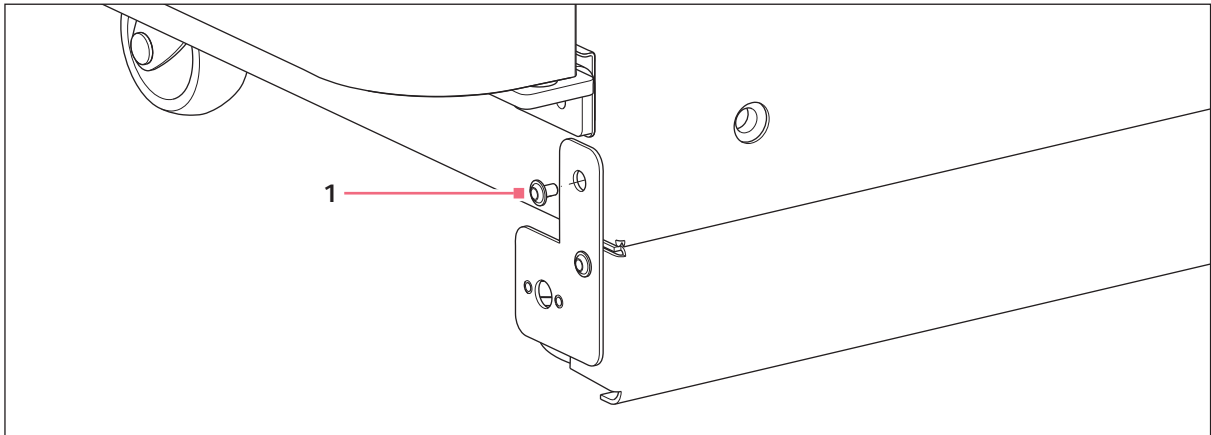

Fig. 4-3: Side foot shield bracket

**1 M4 screw inserted here to fasten the side foot shield bracket to the incubator shaker**

4. Repeat Steps 1 through 3 for the left side foot shield.
5. Push fit the remaining foot shield onto the bottom front of the incubator shaker. Be sure to align its pins with the holes on the incubator shaker and on the mounting brackets of the side foot shields.

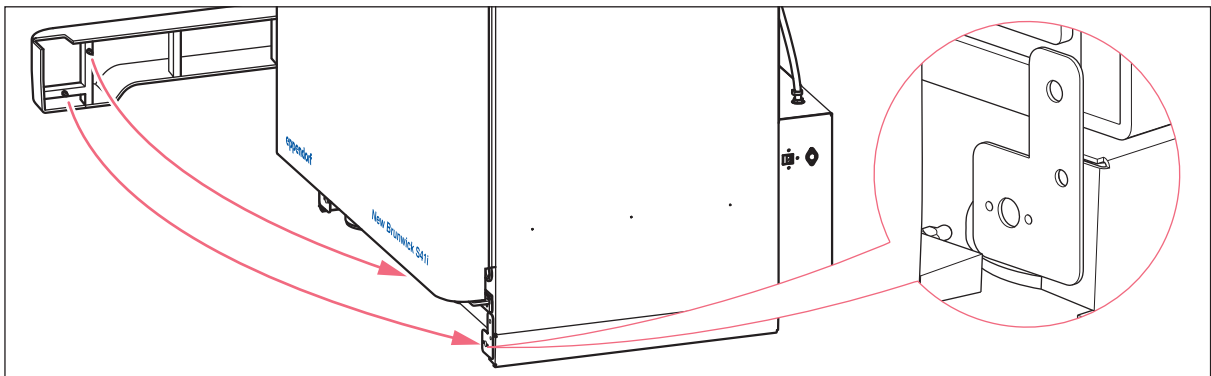

Fig. 4-4: Front foot shield installation

## 4.5 Removing the battery insulating strip

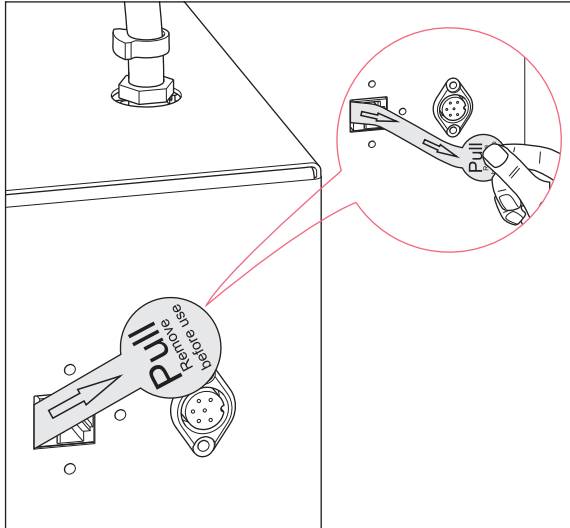

Fig. 4-5: Removing of the battery insulating strip

Carefully pull the battery insulating strip out of the ethernet connection port to activate the backup battery.

The backup battery retains clock time and date, e.g. in case of power outage.

## 4.6 Platform Assemblies

A platform, which is required for operation, is a separate item, not included with the shaker assembly. The S41i platform, measuring 612 × 356 mm (24 × 14 in), will accept a wide range of clamps for flasks, test tubes, etc.

## 4.7 Installation of Platform



Prior to use, a platform must be installed on the incubator shaker.

The incubator shaker is shipped with four Allen head platform screws installed in the four bearing housing uprights, as shown below:

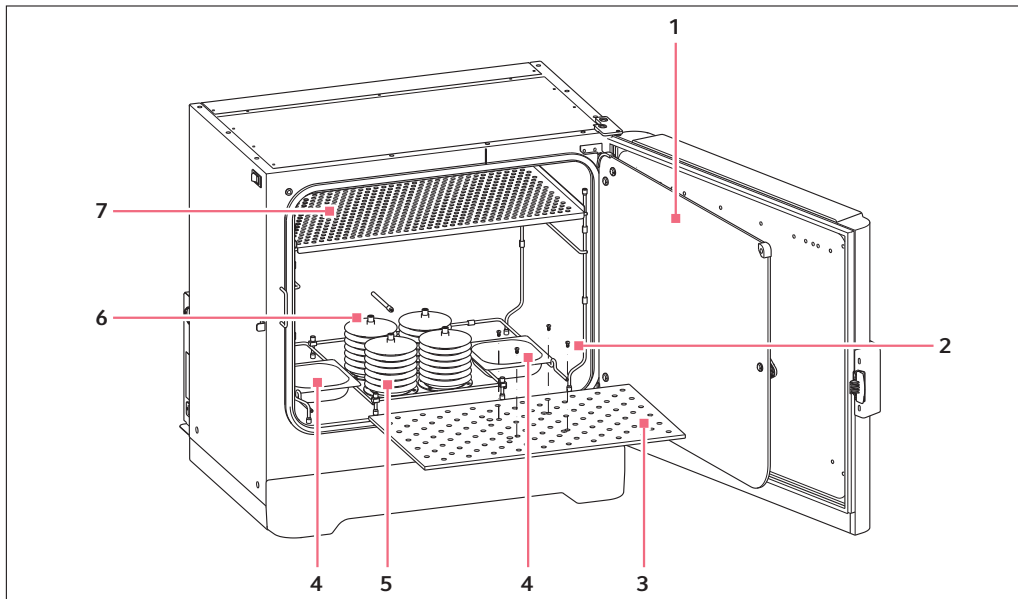



Fig. 4-6: Installing platform

- |                           |                                       |
|---------------------------|---------------------------------------|
| <b>1 Glass inner door</b> | <b>5 Bearing housing</b>              |
| <b>2 Allen screws</b>     | <b>6 Bearing housing uprights</b>     |
| <b>3 Platform</b>         | <b>7 Top shelf, shipped installed</b> |
| <b>4 Humidity trays</b>   |                                       |

1. Set the mains/power to OFF and unplug the incubator shaker.
2. Remove the platform screws, then use them to install the platform over the bearing housing.

## 4.8 Flask Clamp Installation

Flask clamps purchased for use with the platform require installation. Clamps are installed by securing the base of the clamp to the platform with the correct type and number of screws. All clamps are shipped complete with hardware.

-  To avoid glass breakage check that the flask clamps are fixed. When using sticky tape or sticky pad check if the surfaces are dust free.  
Do not use sticky tape on the platform as it may lead to damages.  
Use the sticky pad adapter kit, if you want to use sticky pads.
-  The S41i platform requires 10-24 × 5/16-inch Phillips head screws (which are supplied) to fasten flask clamps.  
With one shelf installed, Erlenmeyer flasks larger than 1 L are too tall for the chamber; to use 2 L – 4 L Erlenmeyer flasks, remove the shelf.

Clamps for 2.8 L Fernbach flasks and 2 L – 4 L Erlenmeyer flasks are shipped with an additional girdle to keep the flasks in place. The girdle is an assembly of springs and sections of rubber tubing. One girdle is already in place on the clamp, the other is packed separately.

To install the double girdle clamps:





1. Place the clamp on the platform, aligning its mounting holes with holes on the platform. Secure the clamp in place using the flat head screws provided (#S2116-3051, 10-24 x 5/16-inch).  
 Three different types of screws are shipped with the clamps, to identify the proper screws (see Fig. 4-7 on p. 21).
2. With the first girdle in place, as delivered, on the upper part of the clamp body, insert an empty flask into the clamp.
3. After making sure the sections of tubing are located between the clamp legs, roll the first girdle down the legs of the clamp as far as it can go. The tubing sections will rest against the platform, and the springs will be under the clamp base.
4. Place the second girdle around the upper portion of clamp body (just as the first girdle was initially). Make sure that its spring sections rest against the clamp legs, while its rubber tubing sections sit against the flask, in between the clamp legs.



Fig. 4-7: Clamp fastener

Eppendorf line flask clamps are used on a variety of incubator shaker platforms. Flat head screws of different lengths and thread pitch are used to secure the clamp. The following table identifies the proper screw for your incubator shaker application by reference to the head style. Select the appropriate screws and set the others aside.

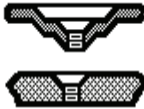
Description	Part number	Qty	Application
 10-24 × 5/16 (7.9 mm) flat Phillips (+) head screw	S2116-3051	1	5/16" (7.9 mm) thick aluminum, phenolic and stainless steel platforms. 

-  One-liter and larger flask clamps are fastened with 5 screws.

## Installation

New Brunswick™ S41i  
English (EN)

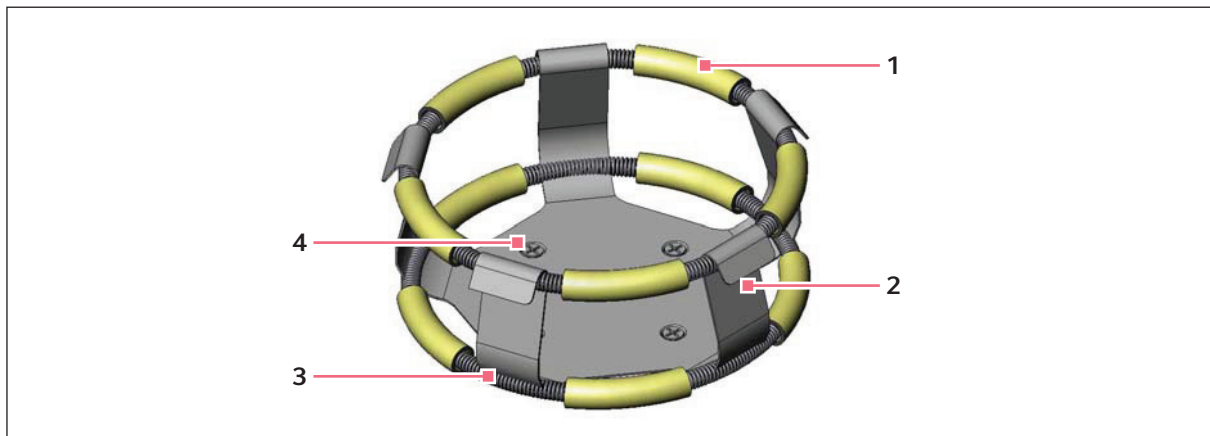

Fig. 4-8: Double girdle clamp installation

- |   |   |
|---|---|
| <b>1 Upper girdle with girdle tubes</b> | <b>3 Lower girdle with girdle tubes</b>     |
| <b>2 Clamp body (legs and base)</b>     | <b>4 Clamp mounting holes (quantity: 5)</b> |



The upper girdle secures the flask within the clamp, and the bottom girdle keeps the flask from spinning.

### 4.9 Stacking Instructions

The device is designed to safely stack one S41i on top of another S41i with the optional stacking kit. The kit includes installation instructions. It is not possible to put any other type of incubator shaker or heavy apparatus on top, as the top cover and stacking kit are designed to support only the feet of another S41i.

### 4.10 Electrical Connections



#### CAUTION! Risk of electrical hazard

- ▶ Before making electrical connections, be sure to check the following list.

1. If you have not already done so, check that the voltage and frequency of your incubator shaker (name plate) are compatible with your mains/electric supply.



#### NOTICE! Risk of material damage

- ▶ An earthed/grounded electrical outlet is necessary for the safe operation of this instrument.

2. Set the circuit breaker on the left side of the incubator shaker to the OFF position.

### 4.11 Setting Up

1. If necessary, level the incubator shaker by adjusting the feet, after removing the foot shields. Place a small level on the shelf of the incubator shaker. Adjust the leveling feet until the incubator shaker is level

and stable. Lock the leveling feet in place by tightening the locking nuts on each foot. Reinstall the foot shields.

2. Fill each humidity tray halfway with distilled water only (approximately 250 mL) if you wish to use them for humidification.

**i** Use of any other types of water including deionized water and chlorinated additives will cause corrosion inside the incubator.

**i** Be sure to install the humidity trays one at a time, after wiping the bottom and edges dry. If you will not use them for humidification, install them anyway to catch spills.

3. Place the humidity trays one at a time onto the parallel support rods on either side of the bearing housing at the bottom of the incubator shaker. Sit them behind the stopper bends, making sure that the back edge of each tray fits under the end of the condensation/spill channel.

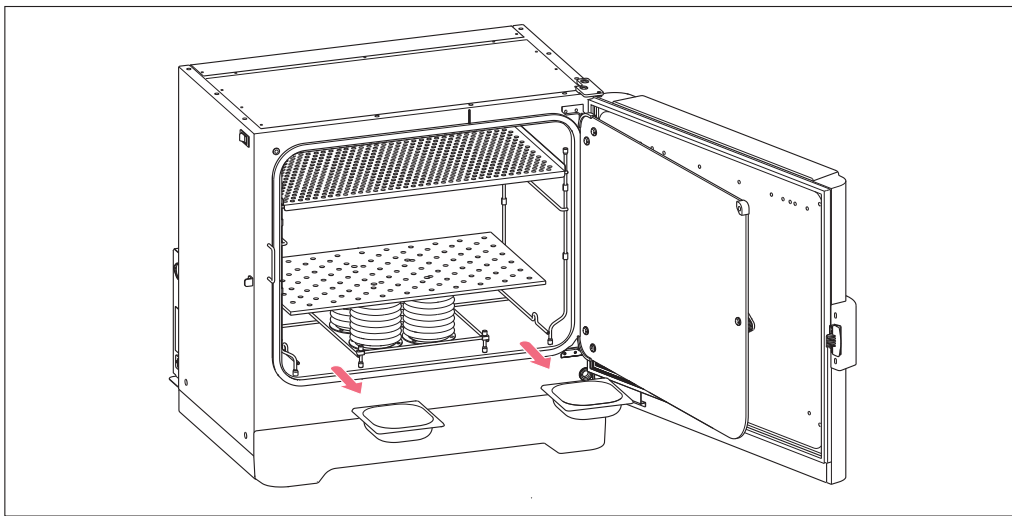

Fig. 4-9: Installing the humidity trays

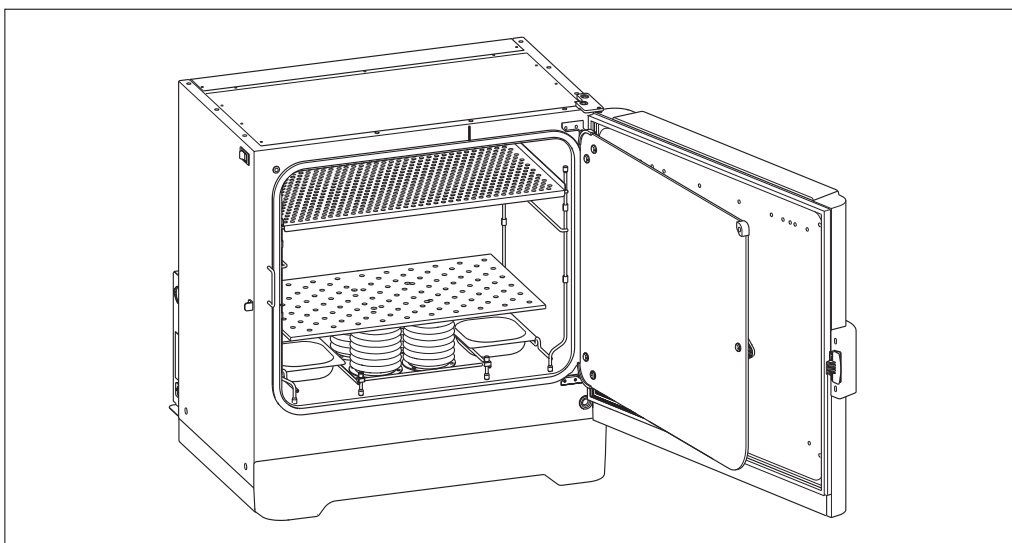

Fig. 4-10: Humidity trays, installed

## 4.12 Making Connections

---



### **DANGER! Unconsciousness and death by elevated levels of CO<sub>2</sub>**

Elevated levels of CO<sub>2</sub> may be found in the operating area of the CO<sub>2</sub> incubator shaker.

- ▶ Wear your personal protective equipment.
  - ▶ If the laboratory is not properly ventilated, use a CO<sub>2</sub>/O<sub>2</sub> alarm system.
  - ▶ Check the tube connection system with a leakage test.
  - ▶ Read the *Information on performing a risk assessment for the operation of incubators with CO<sub>2</sub> and N<sub>2</sub>* from Eppendorf AG.
- 



### **WARNING! Risk of explosion**

- ▶ Use gases in this equipment only within the range between their lower explosion limit (LEL) and their upper explosion limit (UEL).
  - ▶ If your process requires or produces gases, be sure to verify their LEL and UEL concentration range (available online or ask your gas supplier).
- 



### **WARNING! Lack of safety due to incorrect gas installation or insufficient ventilation**

- ▶ Observe the national standards and regulations for the use/handling of gas.
  - ▶ Installation and connection of gas tubings should be done by educated personnel.
- 



### **WARNING! Risk of personal injury**

- ▶ Elevated levels of CO<sub>2</sub> may be found in and around the operating area of the CO<sub>2</sub> incubator.
  - ▶ Wear personal protective equipment (PPE).
  - ▶ Use a CO<sub>2</sub>/O<sub>2</sub> alarm system for the lab if the room is not properly ventilated.
  - ▶ Check the tube connection system with a leakage test.
- 



### **WARNING! Risk of personal injury**

- ▶ Be sure to remove the sensor's colored protective cover(s) before performing routine work. CO<sub>2</sub> levels will not be detected or controlled properly if the colored protective cover remains on the sensor. This could lead to over-saturation of CO<sub>2</sub> gas in the chamber with possible leakage out of the device.
- 



### **WARNING! Danger due to incorrect voltage supply.**

- ▶ Only connect the device to voltage sources which correspond with the electrical requirements on the name plate.
  - ▶ Only use earth/grounded sockets with a protective earth (PE) conductor.
  - ▶ Only use the mains/power cord supplied.
- 



### **NOTICE! Risk of material damage**

The gas tubing and in-line gas filter will burst or crack due to high pressure.

- ▶ Incoming CO<sub>2</sub> and N<sub>2</sub> gas pressure must not exceed 0.2 MPa (2.0 bar, 29.0 psi).
-





In-line regulators are provided on the back of the incubator shaker. These are essential to proper operation.

1. Connect the incubator shaker to the CO<sub>2</sub> supply using the ~6 mm plastic tubing (with installed HEPA filter) by attaching the tubing from the supply to the top regulator inlet on the back of the incubator shaker.

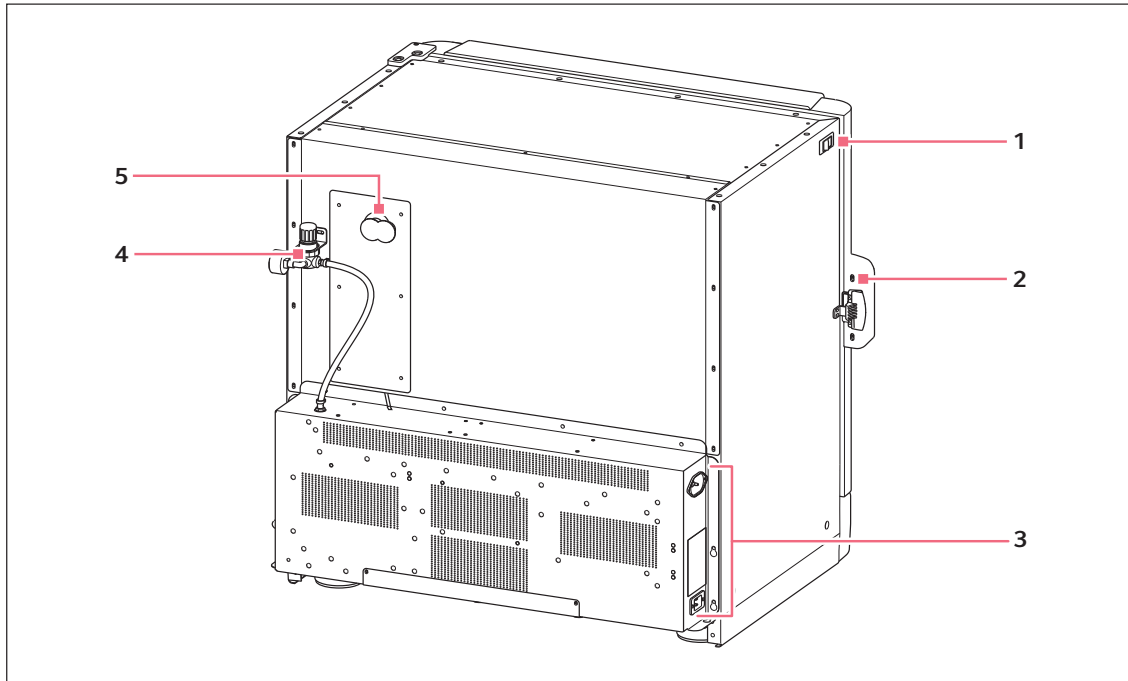

Fig. 4-11: Rear view (back panel removed)

- |   |   |
|---|---|
| 1 ON/OFF switch   | 4 In-line gas regulators (access from the side) |
| 2 Door handle   | 5 Access port                                   |
| 3 See <i>Control box (right side)</i> figure for details. |   |

2. Use the tubing clips provided to eliminate CO<sub>2</sub> leaks.



**WARNING! Risk of electrical hazard**

- ▶ Before making electrical connections, verify that your mains/power supply voltage matches the voltage of your incubator shaker and that the on/off switch is in the OFF position.

3. Plug the mains/power cord into its receptacle on the right side of the control box.
4. After verifying that your supply voltage matches the voltage specified for your incubator shaker and that the ON/OFF switch is OFF, plug the cord into your earthed/grounded mains/power supply outlet.
5. Press the Auto-Zero HEPA filter gently into the white plastic filter socket on the right side of the control box.

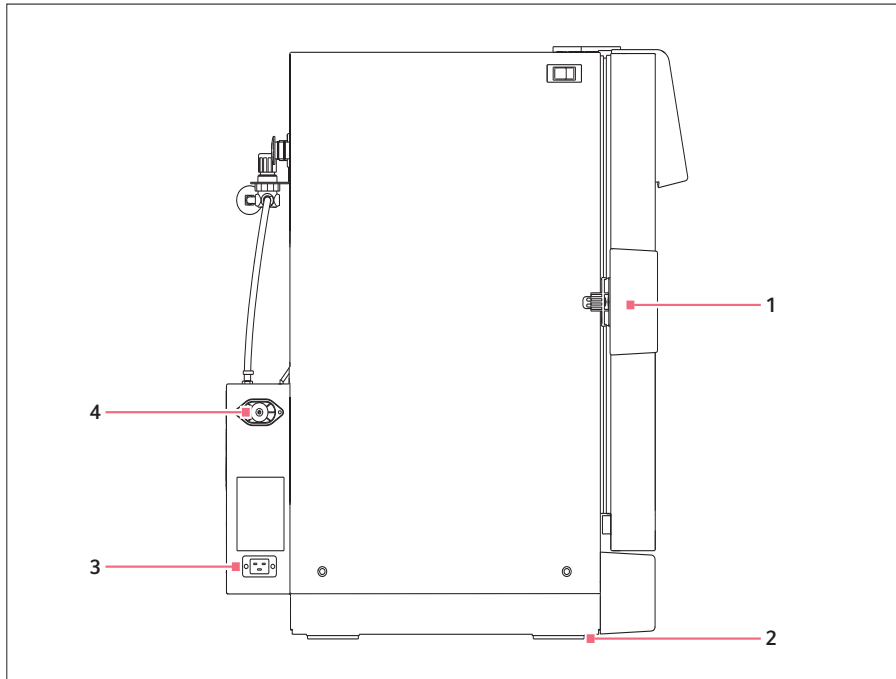

Fig. 4-12: Control box (right side)

- |   |                                  |
|---|----------------------------------|
| <b>1 Door handle</b>                              | <b>3 Mains/power receptacle</b>  |
| <b>2 Adjustable foot (shown with side shield)</b> | <b>4 Auto-Zero filter socket</b> |

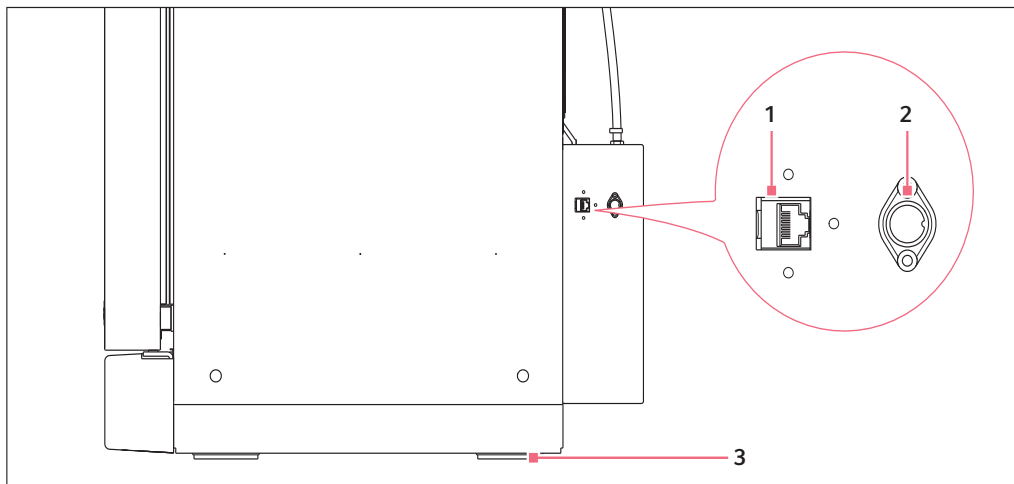

Fig. 4-13: Control box (left side)

- |   |   |
|---|---|
| <b>1 Ethernet connection</b>            | <b>3 Adjustable foot (shown with side shield)</b> |
| <b>2 BMS relay contact alarm socket</b> |   |

### 4.13 Ethernet Connection

**i** Only connect devices that meet the safety requirements defined in IEC 60950-1.

The ethernet connection is provided as a connection to a personal computer on which you can run *BioCommand® SFI* software to log data from its operation. Speak to your sales representative for information about this program.

### 4.14 BMS relay contact alarm

**i** Only connect devices that meet the safety requirements defined in IEC 60950-1.

The BMS (Building Management System) Relay Contact Alarm allows a signal from a central alarm system to be switched ON or OFF to indicate an alarm condition at the incubator shaker.

The following alarm conditions will activate the system:

- over-temperature
- under-temperature
- system failure
- CO<sub>2</sub> high
- CO<sub>2</sub> low.

As an integral option, the alarm can be programmed to indicate when the power fails (e.g. due to an electrical fault) or is switched off. If the power failure warning is active, the relay contacts will be reversed (pin 4, which is normally open, becomes closed and pin 6, which is normally closed, becomes open).

The system is connected at the rear of the incubator shaker via a standard 6-pin DIN socket (see Fig. 4-13 on p. 26) for location. The matching plug is provided.

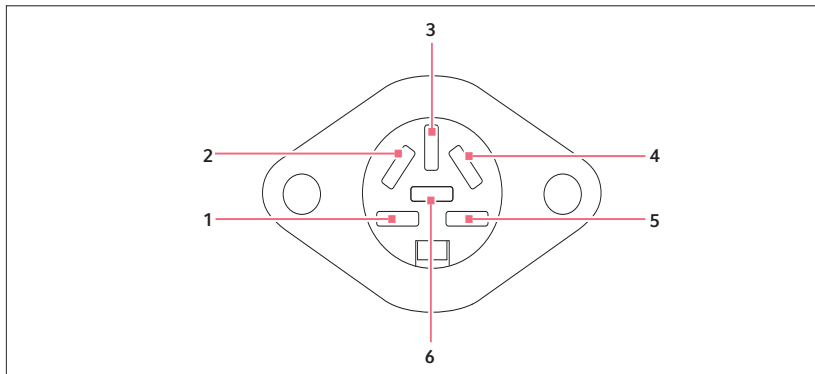

Fig. 4-14: BMS relay contact alarm socket

Pin		Designation
1 – 3	Not connected	
4	Normally closed	To access the relay contacts. Contact limits are 3 Amps @ 24 V DC and 3 Amps @ 34 V AC.*
5	Common	
6	Normally open	

\*Cable length should not exceed 3 m (9.8 ft) to comply with EMC requirements

The setting for the alarm system is ON.

4.14.1 Incubator operating, no alarm

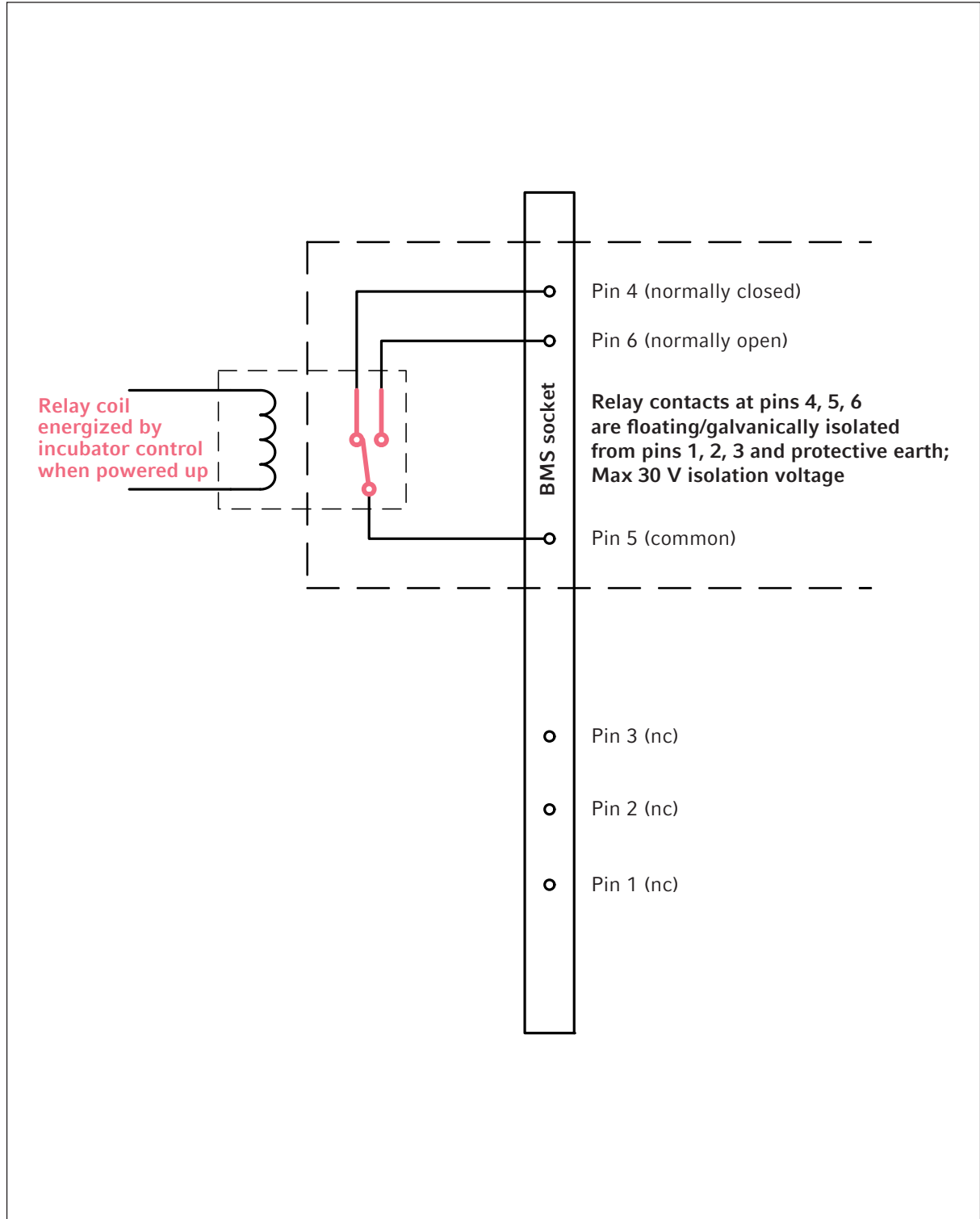

#### 4.14.2 Incubator with alarm triggered

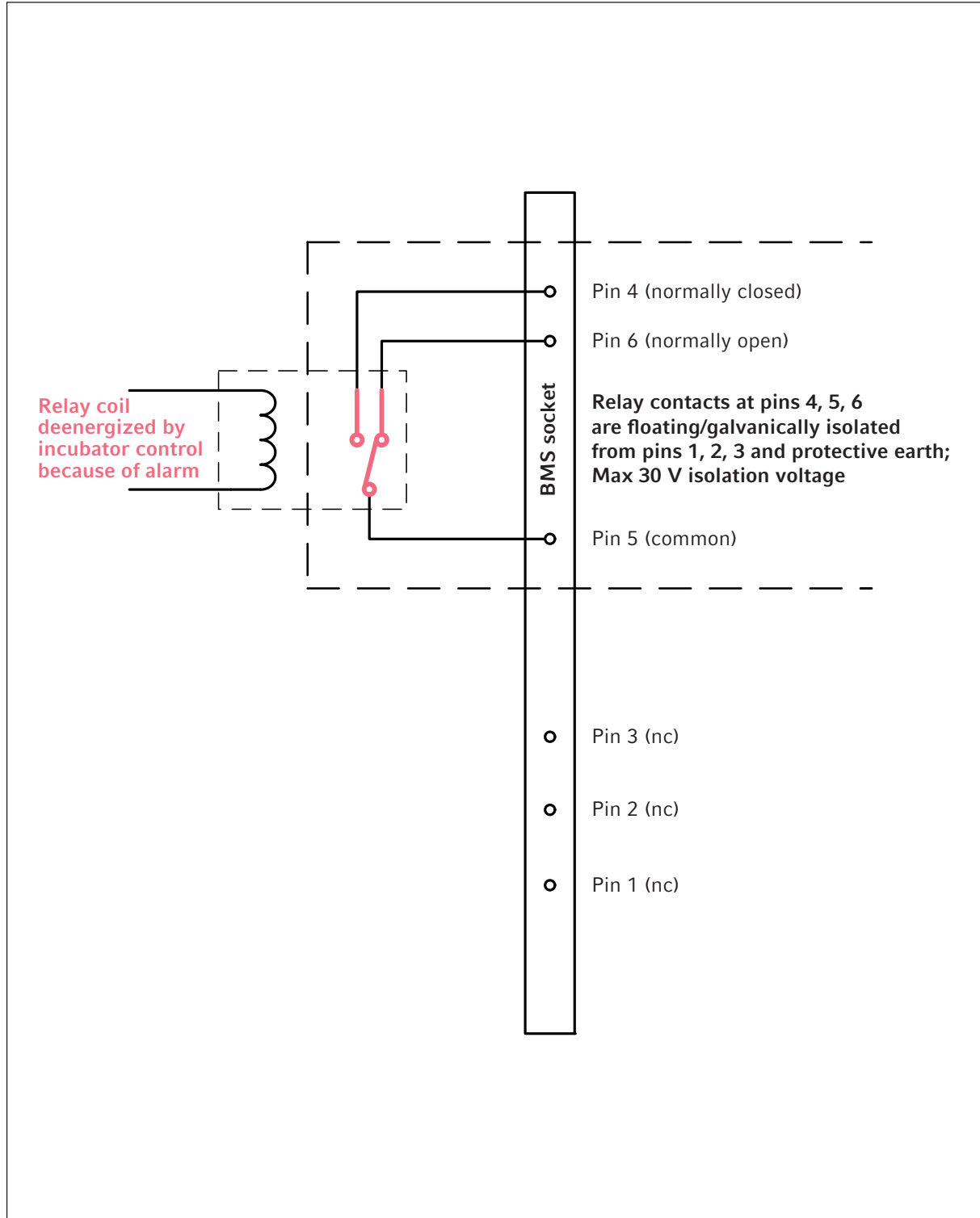



## 5 Operation

### 5.1 Preparing for operation



#### **WARNING! Risk of personal injury**

- ▶ Do not forget to remove the sensor protective cover when putting the device into routine work. If the cover remains on the sensor, CO<sub>2</sub> will continuously flow into the incubator and possibly leak out of the device.



#### **NOTICE! Risk of material damage**

The gas tubing and in-line gas filter will burst or crack due to high pressure.

- ▶ Incoming CO<sub>2</sub> and N<sub>2</sub> gas pressure must not exceed 0.2 MPa (2.0 bar, 29.0 psi).

1. Remove the colored protective cover from the CO<sub>2</sub> sensor. Do not remove the white porous cover. Save the colored cover for reuse when the incubator is to be cleaned.
2. Connect the device to a earthed/grounded power supply.
3. Switch the device on.  
The display will illuminate immediately.
4. Turn on the CO<sub>2</sub> gas supply. The pressure regulator of the gas supply is to be set to 0.05 MPa (0.5 bar/ 7.2 psi).
5. The chamber setpoints are pre-programmed at 37 °C and 5 % CO<sub>2</sub>. Leave the incubator shaker on until the programmed chamber temperature and CO<sub>2</sub> concentration have been reached.
  -  • The CO<sub>2</sub> valve is disabled until the incubator shaker reaches the temperature setpoint. After the temperature setpoint is reached, the CO<sub>2</sub> valve is activated.
  - If mains/power is interrupted to the incubator shaker long enough for the temperature to drop below setpoint, the CO<sub>2</sub> valve will be deactivated until temperature setpoint is achieved again. This procedure serves to avoid spurious CO<sub>2</sub> readings.
6. Leave the incubator shaker running overnight to allow conditions to stabilize.

CO<sub>2</sub> sensors are calibrated at the factory to control accurately at 5 % CO<sub>2</sub> and 37 °C. Changing the temperature or the CO<sub>2</sub> value setpoints leads to deviations in accuracy.



- ▶ Close the outer door properly to avoid condensation or contamination.

### 5.2 Using the Water Trays

If humidification is required, each of the two humidity trays should be filled with approximately 250 mL of warm (~ 37.0 °C) distilled water at this time.

To reduce the risk of contamination, clean the tray every 10–14 days with a solution of 70 % isopropyl alcohol and 30 % distilled water.



#### NOTICE! Risk of material damage

- ▶ To avoid possible damage to the CO<sub>2</sub> sensor, never leave water in the humidity tray while the incubator/shaker is switched off, or when a high temperature disinfection cycle is initiated (optional feature).



Use distilled water only in the water trays. The usage of any other types of water including deionized water and chlorinated additives will cause corrosion inside the incubator. Do not move the incubator, when the water trays are filled. Spilled water could cause corrosion in the chamber.



The humidity level within the chamber is not adjustable. The chamber will reach between 85 and 95 % relative humidity at 37 °C (depending on ambient humidity) using the water trays.

## 5.3 Starting the Incubator Shaker



The incubator shaker will not operate if the door is open.

To initially start the incubator shaker, close the door, make sure the incubator shaker's mains/power cord is securely plugged in, and turn the mains/power switch (located on the top left side of the instrument) to the **ON (I)** position.

The initial display will come on for a few moments, then you will see the **STATUS** screen (see *Preparing for operation on p. 31*).

In the unlikely event that the audible alarm sounds upon start-up, a yellow **ALARM** screen will appear, prompting you to mute and to acknowledge the alarm:

1. Press the **Mute** button in the screen to silence the audible alarm.
2. If you have Administrator status (see *USER ACCESS screen on p. 54*), follow the instructions to acknowledge the alarm; if you have User status, get an Administrator to acknowledge the alarm.
3. Use the **LEFT** and **RIGHT** arrow buttons to see if there are any other alarms to acknowledge.
4. If any alarms continue to be unacknowledged, there will be a yellow star behind the **ALARM** icon in the **STATUS** and **SUMMARY** screen until the alarm is acknowledged.
5. After acknowledgement, the reason for any alarm should be tended to and rectified. For details on using alarms (see *ALARM SETTINGS screen on p. 40*).

## 5.4 Using the Touchscreen

### 5.4.1 Initial display and STATUS screen

This is the first screen you will see when you turn the incubator shaker ON:





This is a sample screen, the version number shown will vary.

1

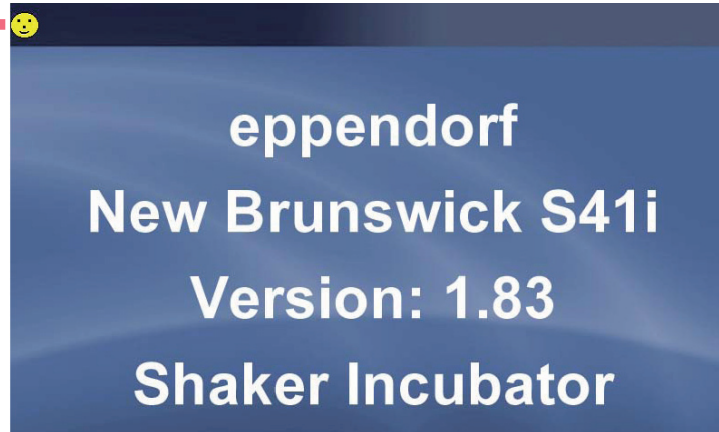

- 1 The yellow smiling icon in the upper lefthand corner of each screen indicates that the software is working. If at any time you see a red frowning icon, the software is not working and will require troubleshooting.

The initial screen will remain displayed for a few moments, then change to the **STATUS** screen:



If the display showed the **SUMMARY** screen when it was powered off, when you restart, the **SUMMARY** screen (see *SUMMARY screen on p. 42*) will appear instead of the **STATUS** screen. You may need to calibrate the touchscreen to your touch (see *SET CALIBRATION screen on p. 46*).



If the *ALARM* icon appears, an alarm condition exists. This needs to be acknowledged and rectified. Go to the *ALARMS* screen (see *ALARM SETTINGS* screen on p. 40).

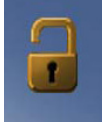

The presence of the open *LOCK* icon indicates that the user screens are unlocked for access to make changes. When the padlock is closed, the screens are locked against changes; Admin level security is required to make edits.

### 5.4.2 Starting the platform

The **STATUS** or **SUMMARY** screen will display a *START* button to launch operation of the incubator shaker platform. The *START* button changes to a *STOP* button when pressed.

1. Press *START* from **STATUS** or **SUMMARY** screen.

The confirmation screen appears.

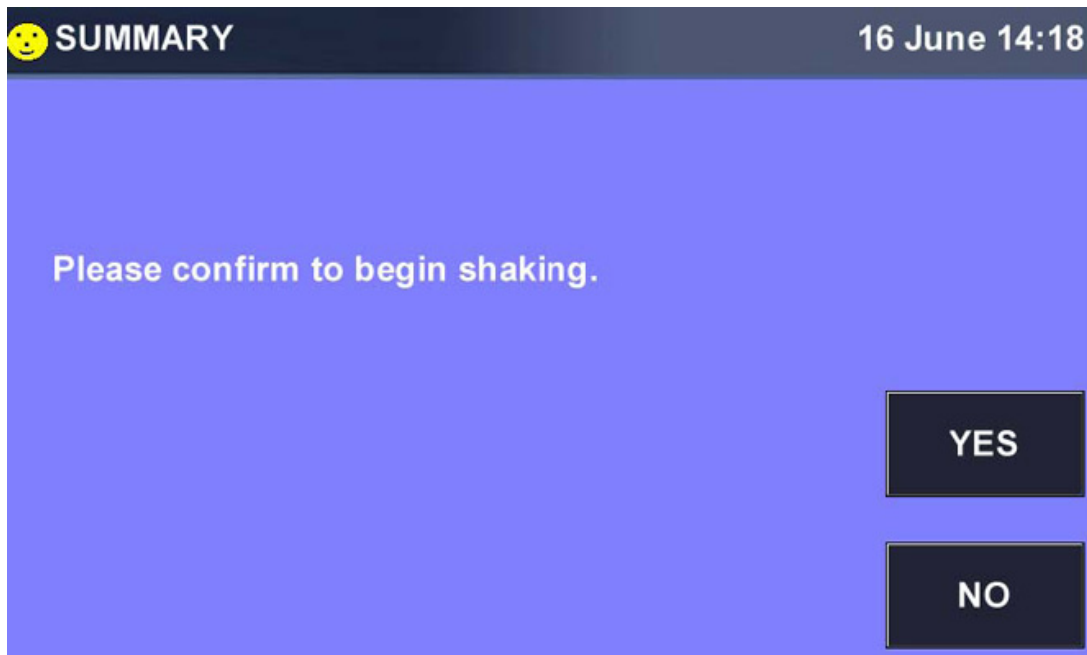

2. Press *YES* to start the incubator shaker platform.  
The **STATUS** or **SUMMARY** screen displays the *STOP* button.



### 5.4.3 Stopping the platform

The **STATUS** or **SUMMARY** screen will display a *STOP* button to stop operation of the incubator shaker platform. The *STOP* button changes to a *START* button when pressed.

1. Press *STOP* from **STATUS** or **SUMMARY** screen. The confirmation screen appears.

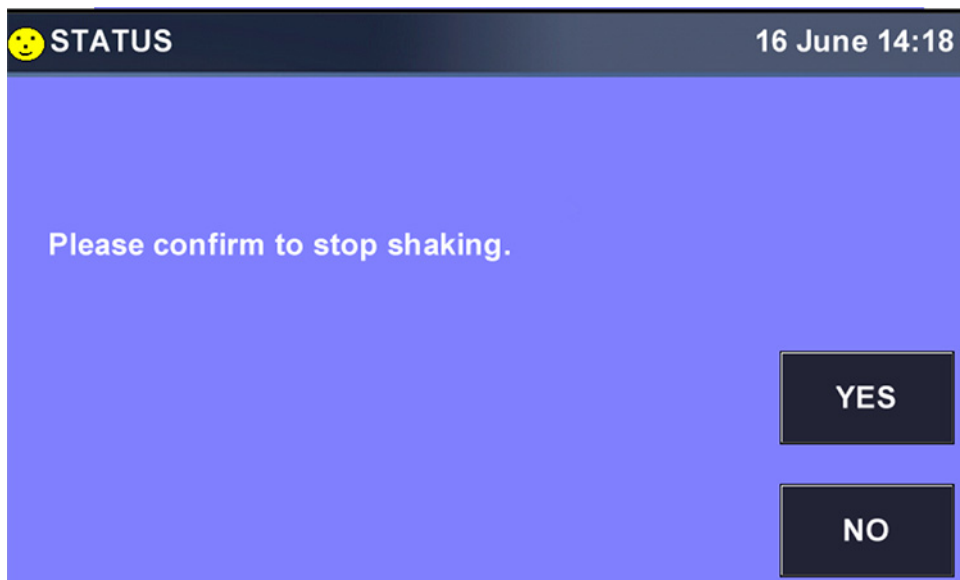

2. Press *YES* to stop the incubator shaker platform. The **STATUS** or **SUMMARY** screen displays the *START* button

#### 5.4.4 Setting the temperature

At any time you can press the °C line in the **STATUS** screen to open the Temperature Range screen, which allows you to set temperature parameters:

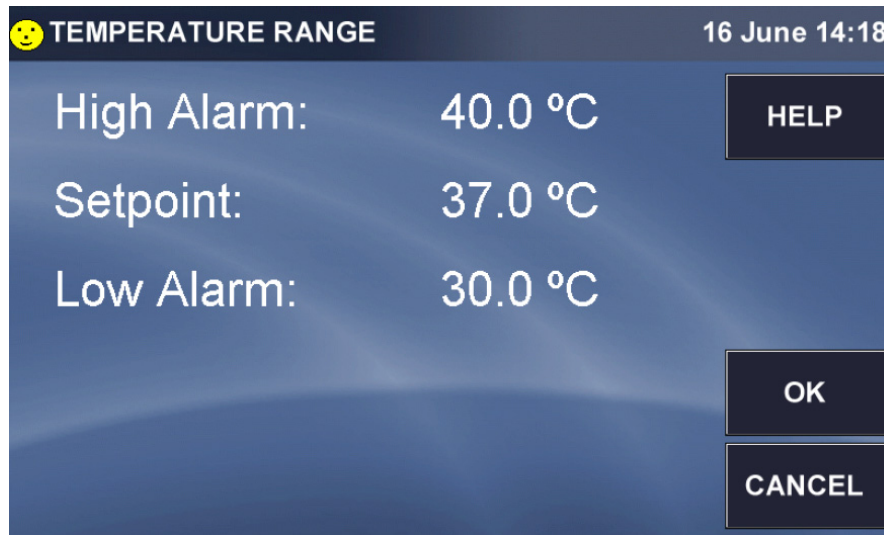

- ▶ Press the High Alarm line and use the popup keypad to set the temperature at which an alarm will alert you to the temperature rising too high.
- ▶ Press the Low Alarm line and use the popup keypad to set the temperature at which an alarm will alert you to the temperature falling too low.
- ▶ Press the Setpoint line and use the popup keypad to set the desired working temperature.

#### 5.4.5 Setting the CO<sub>2</sub> level

At any time you can press the CO<sub>2</sub> line in the **STATUS** screen to open the CO<sub>2</sub> Range screen, which allows you to set parameters for carbon dioxide in the chamber:



- ▶ Press the High Alarm line and use the popup keypad to set the percentage at which an alarm will alert you to the CO<sub>2</sub> level rising too high.
- ▶ Press the Low Alarm line and use the popup keypad to set the temperature at which an alarm will alert you to the CO<sub>2</sub> level falling too low.
- ▶ Press the Setpoint line and use the popup keypad to set the desired percentage of CO<sub>2</sub> in the chamber.

#### 5.4.6 Setting the shaking speed

At any time you can press the **RPM** line in the **STATUS** screen to open the Speed Range screen, which allows you to set parameters for the shaking speed and run time:

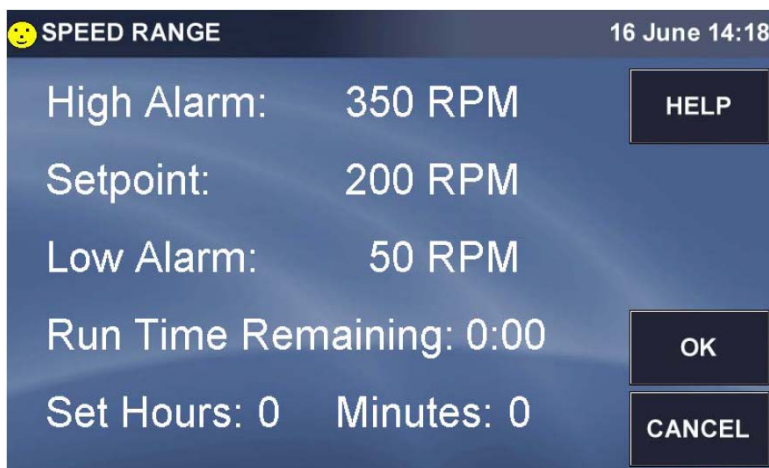

- ▶ Press the High Alarm line and use the popup keypad to set the speed at which an alarm will alert you to the rpm rising too high.
- ▶ Press the Low Alarm line and use the popup keypad to set the speed at which an alarm will alert you to the rpm level falling too low.
- ▶ Press the Setpoint line and use the popup keypad to set the desired shaking speed.
- ▶ Press the Set Hours line to set the number of hours of shaking you wish to program, using the popup keypad.
- ▶ Do the same to Set Minutes.
- ▶ After you program the Hours and Minutes of the run time and then press *OK* the button to return to the **STATUS** screen.
- ▶ Now there will be a *STOPWATCH* icon next to **RPM**, to indicate that the countdown of Run Time has been enabled:

## 5.5 MENU 1 Screen

- ▶ Press *MENU* button to open the first of two **MENU** screens:



- ▶ Press the *Status View* button or *DONE* button at any time to return to the main **STATUS** View screen.



When you press the *DONE* button in the **MENU** screen's , if you had previously been viewing the **SUMMARY** screen, the system will return you to the **SUMMARY** screen.

### 5.5.1 HELP function

- ▶ Whenever there is a *HELP* button in a screen, you can press it at any time to find additional information regarding the screen you are viewing.

### 5.5.2 EVENT LOG

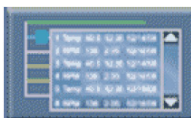
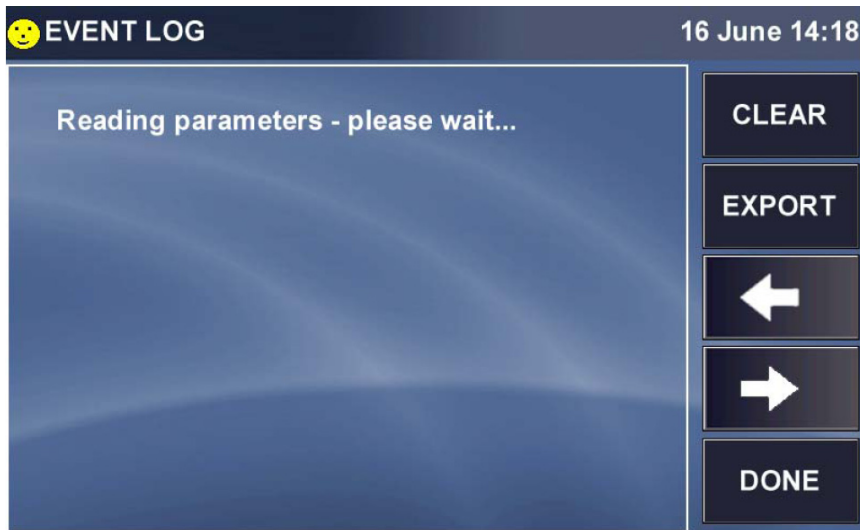
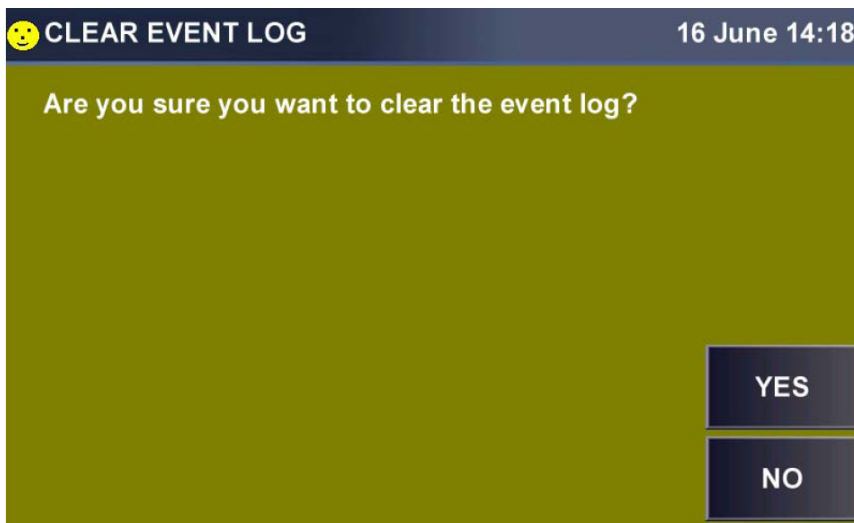

Fig. 5-1: Event log button

- ▶ In the first **MENU** screen, press the *Event Log* button to open the EVENT LOG:



- ▶ Press any of the events listed in this screen to open an **EVENT DETAIL SCREEN**, then press the *DONE* button to return to the **EVENT LOG** screen.
- ▶ To clear the **EVENT LOG** screen, press the *CLEAR* button; you will be prompted to confirm your choice with this screen:



- ▶ Press the *YES* button to clear the log; press the *NO* button to return to the **EVENT LOG** screen without making changes.
- ▶ Press the *EXPORT* button to save event log data to a USB memory stick/flash drive. You will be prompted with the following screen:

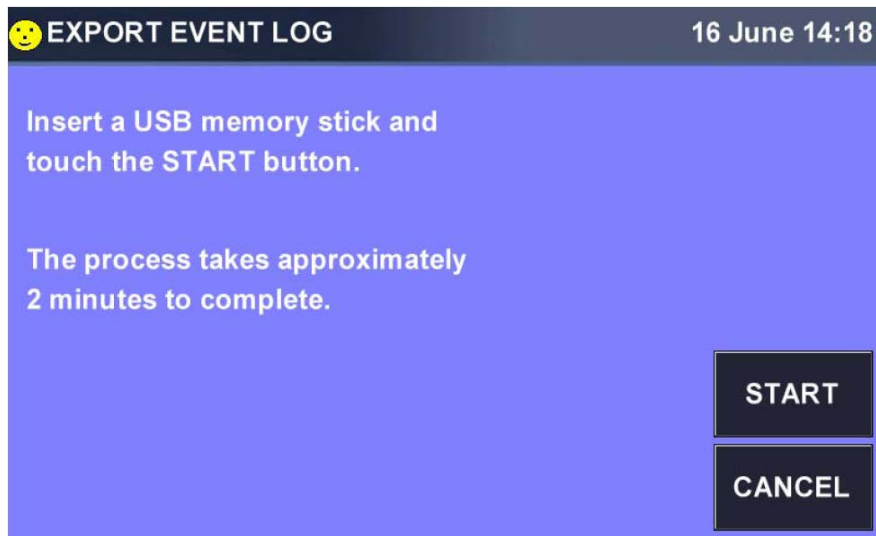

- ▶ Insert the memory stick/flash drive in the USB port located under the touchscreen, then press the *START* button.
- ▶ In the **EVENT LOG** screen you can also press the *LEFT* or *RIGHT* button to view previous or additional **EVENT** data screens.
- ▶ Press the *DONE* button to return to **MENU**.

### 5.5.3 ALARM SETTINGS screen



Fig. 5-2: Alarms button

- ▶ Press the *ALARMS* button in the **MENU 1** screen to open the **ALARM SETTINGS** screen:

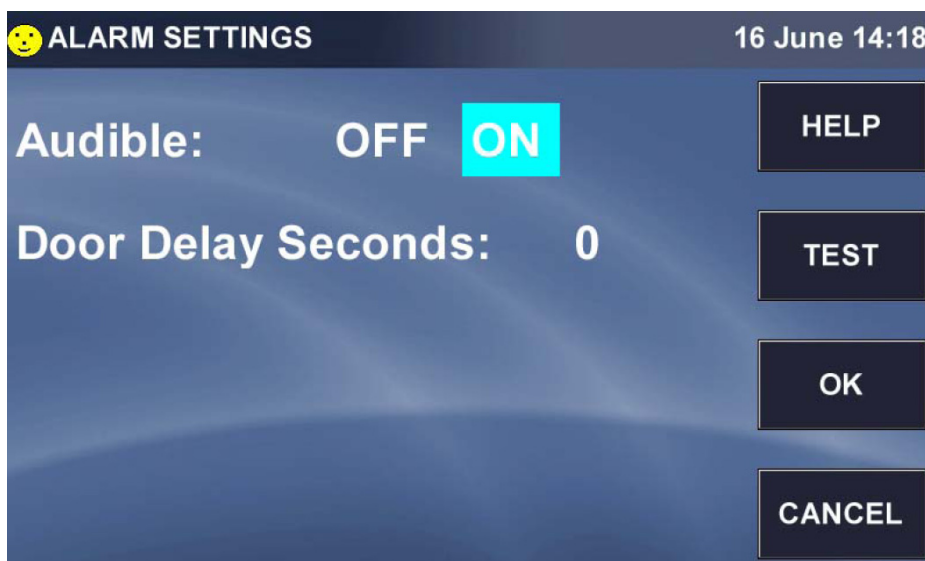



The Audible alarm is either ON or OFF, whichever is highlighted in your screen (it is ON in the sample screen above). To change its status, press anywhere in this line except where it is already highlighted, and it will automatically change.

**If an audible alarm is triggered:**

- ▶ Mute and acknowledge alarm (see *Starting the Incubator Shaker on p. 32*), and rectify the condition that triggered the alarm.

When the door is opened, an alarm is displayed and logged. To delay the triggering of the open door alarm:

- ▶ Press anywhere in the **Door Delay Seconds** line.
- ▶ In the **SET DOOR DELAY SECONDS** keypad that opens:

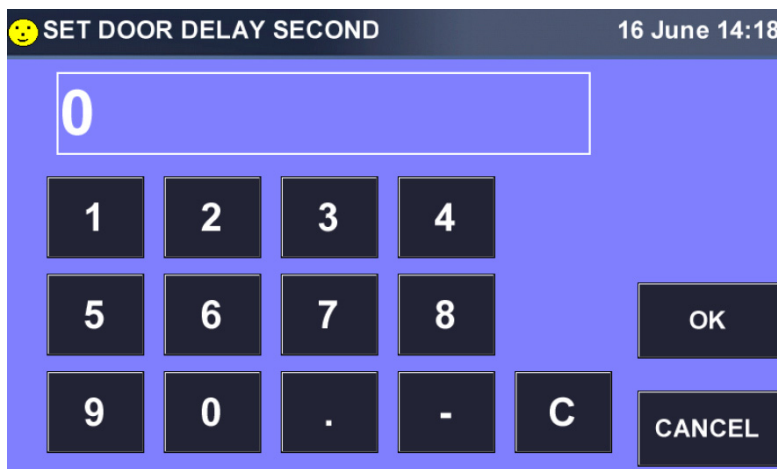

- ▶ Use the keys to enter the desired delay in seconds, then press the *OK* button to save the value. You will return to the **ALARM SETTINGS** screen and your value will be displayed.

**If you wish to test the alarms:**

- ▶ press the *TEST* button to open the **ALARM TEST** screen:

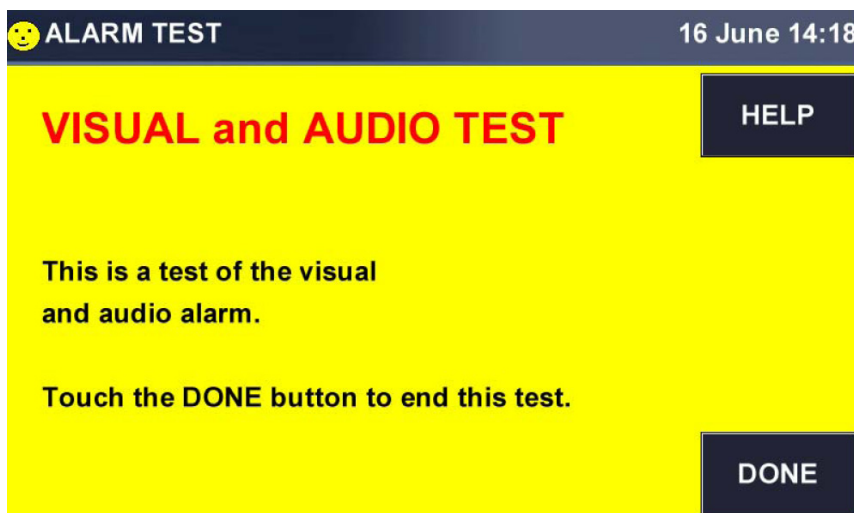

The test will begin automatically with the opening of this screen. You should see a yellowcolored screen with red lettering at the top, symbolizing a visual alarm, and you should hear an audio alarm.

- ▶ Press *DONE* button to acknowledge the test and to stop the audio alarm.
- ▶ Press the *OK* button in the **ALARM SETTINGS** screen at any time to return to the **MENU** screen.

#### 5.5.4 SUMMARY screen

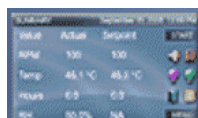
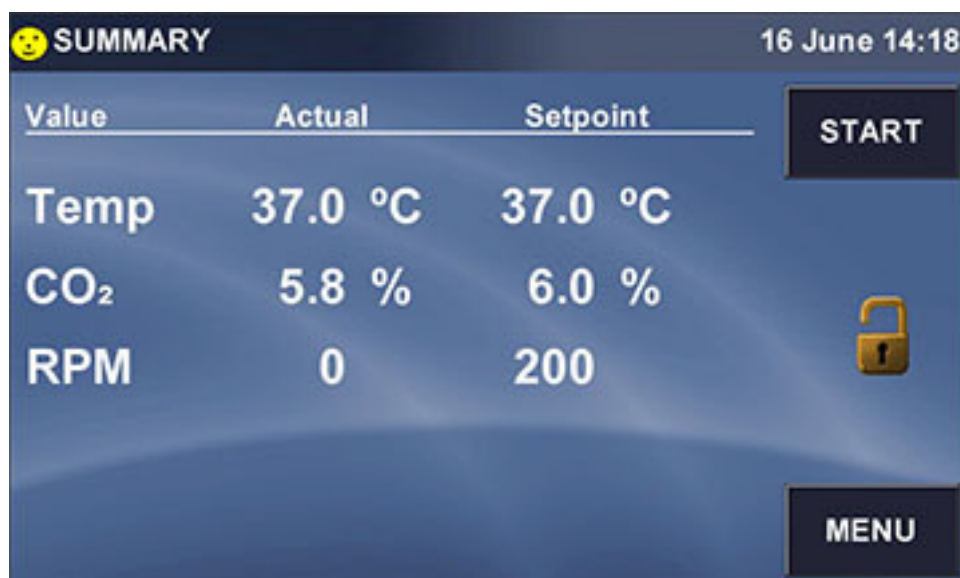

Fig. 5-3: Summary view button

- ▶ Press the *Summary View* button to open the **SUMMARY** screen.



Like the **STATUS** screen, the **SUMMARY** screen has a *START* button which, once it has been pressed to launch operation, becomes a *STOP* button to allow you to stop operation.

If the icon appears, an alarm condition exists. This needs to be acknowledged and rectified. Go to the **ALARMS** screen (see *ALARM SETTINGS screen on p. 40*).

The presence of the open *LOCK* icon indicates that the user screens are unlocked for access to make changes. When the padlock is closed, the screens are locked against changes; Admin level security is required to make edits.

The following table identifies the five values (parameters) that may appear in abbreviated form in the lefthand column of the **SUMMARY** screen:

Abbreviation	Value
Temp	Temperature (°C)
CO <sub>2</sub>	Carbon Dioxide (%)
RPM	Shaking speed (rpm)

As with the **STATUS** screen, press any Setpoint to open that parameter's screen to set or reset the Setpoint.

When you set a Run Time, the *STOPWATCH* icon appears next to RPM in the **SUMMARY** screen, too:

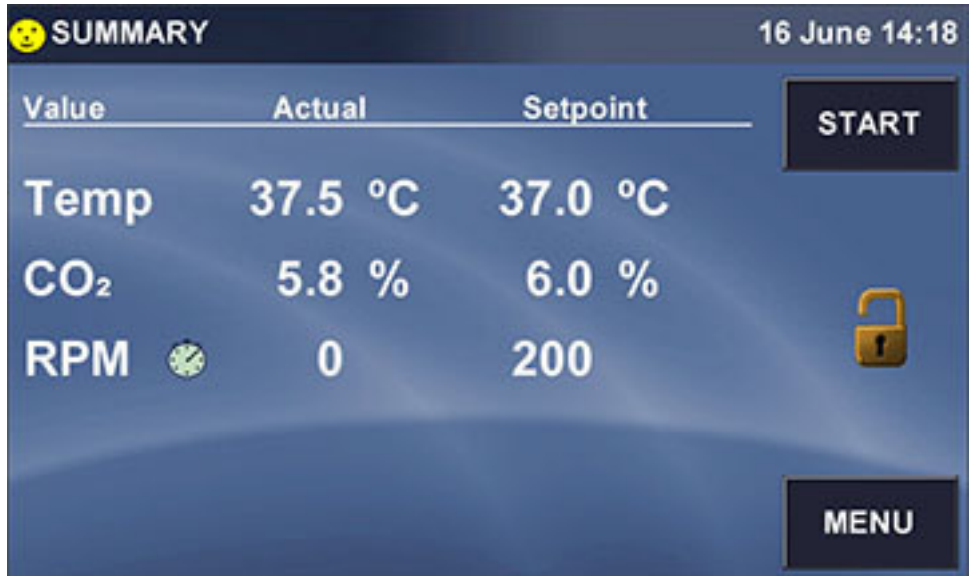

### 5.5.5 EVENT GRAPH screen

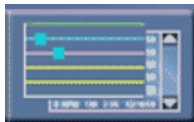
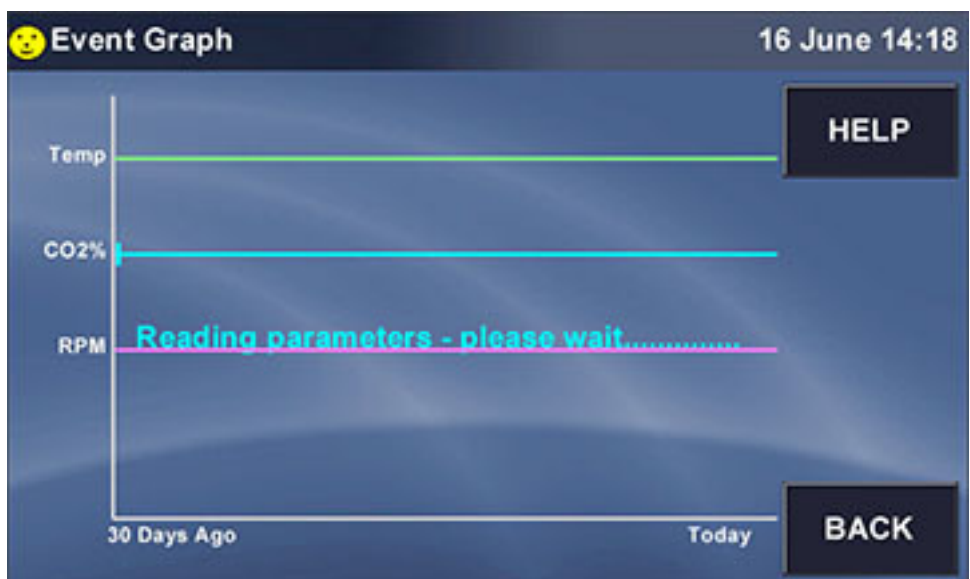
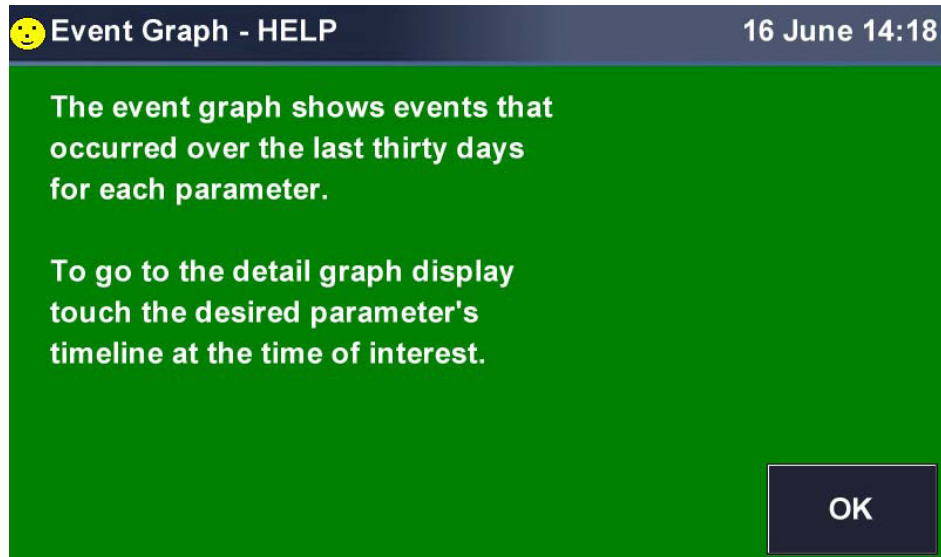

Fig. 5-4: Event graph button

- ▶ Press the *Event Graph* button to open the **EVENT GRAPH** screen:



If you press the *HELP* button, the following screen will appear:



The *BACK* button returns you to the **MENU** screen.

- ▶ Press any parameter's graph line to open that particular graph.

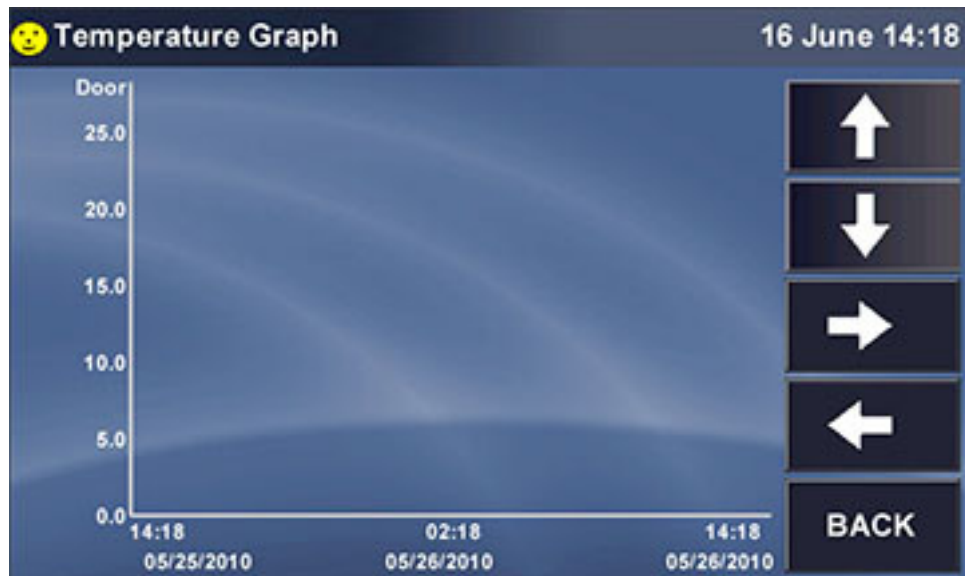

- ▶ Click anywhere along the Y (vertical) axis to open a Span popup screen that allows you to change the scale of this axis:

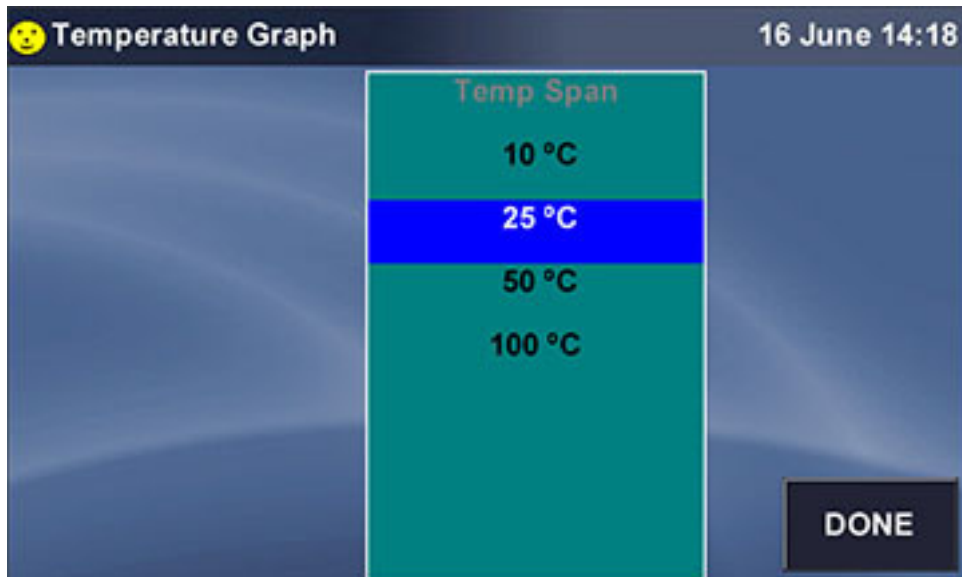

The current view shows from 0.0 °C to 25.0 °C. If you press, for example, 10 °C then press the *DONE* button, the X axis will change to display a scale from 0.0 °C to 10.0 C.

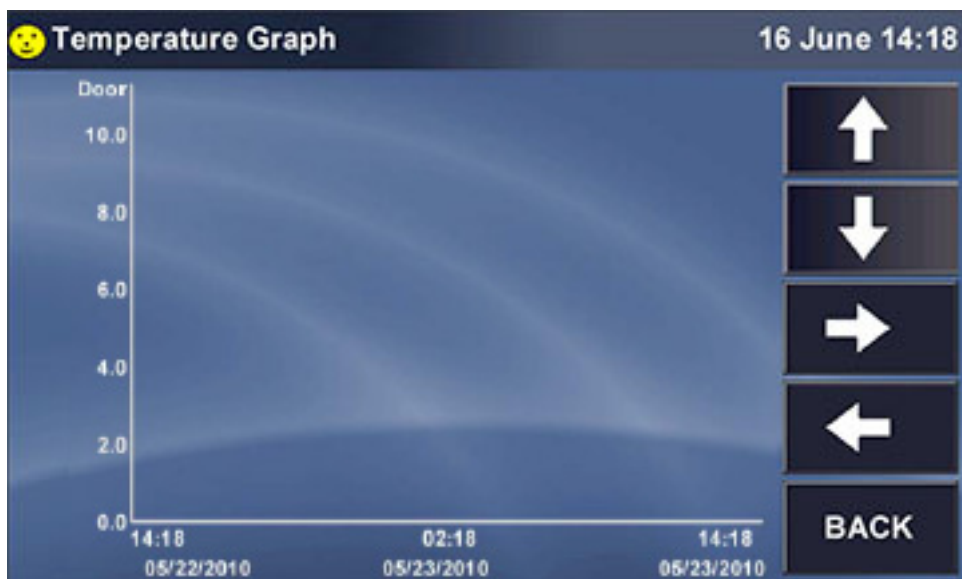

- ▶ Press anywhere along the X axis to open a Time Span popup screen:



- ▶ Press any selection, "3 Days" for example, then press the *DONE* button. The X-axis will now show a time span of 3 days onscreen, between the 1<sup>st</sup> marker on the left and the 3<sup>rd</sup> on the right.
- ▶ At any time, you can use the *UP* and *DOWN* arrow buttons to scroll through values, and use the *LEFT* and *RIGHT* arrow buttons to scroll through Time.

### 5.5.6 SET CALIBRATION screen

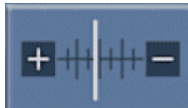

Fig. 5-5: Calibrate button

- ▶ Press *Calibrate* button to open the **SET CALIBRATION** screen:



The following sections explain the options offered in this screen.

### 5.5.6.1 Agitation gain

If you measure the shaking speed (“Actual Speed”) with a tachometer and find that it does not match the speed displayed in the **STATUS** and **SUMMARY** screens (“Indicated Speed”), proceed as follows:

1. Let the unit arrive at the desired shaking speed, then record the Indicated Speed from the display.
2. Use a tachometer to measure the speed and record the Actual Speed.
3. Calculate the Speed correction value using this formula:  
Actual Speed – Indicated Speed = Agitation Gain Value.
4. In the **SET CALIBRATION** screen, press anywhere in the Agitation Gain line. This screen will open:

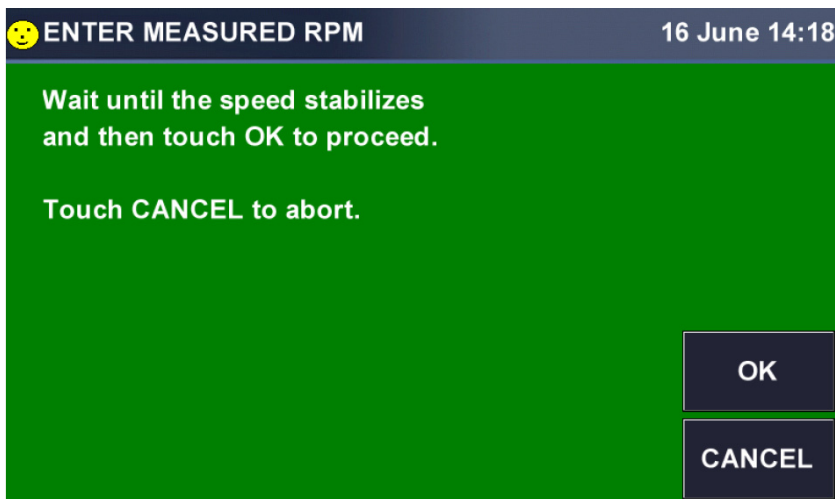

5. When the speed stabilizes, press the *OK* button. This screen will open:

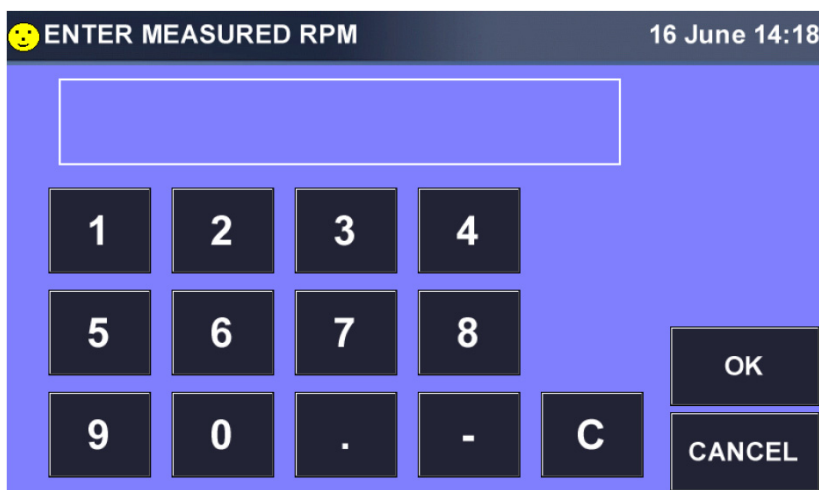

No setpoint or agitation gain below 100 rpm or above 400 rpm can be entered.

6. Use the keypad to enter the RPM as you measured it, then press the *OK* button to save the value.

This allows the system to recalibrate agitation speed.

### 5.5.6.2 Calibrate touchscreen

- ▶ To calibrate the touchscreen, press *Calibrate Touchscreen* and follow the instructions in the screen that opens. You will be prompted to touch the screen at several locations.  
When the calibration has been completed, the system will return to the **SET CALIBRATION** screen.
- ▶ Press the *OK* button to return to the **MENU**.

### 5.5.7 GENERAL SETTINGS screen



Fig. 5-6: General settings button

- ▶ Press the *General Settings* button to open the **GENERAL SETTINGS** screen:

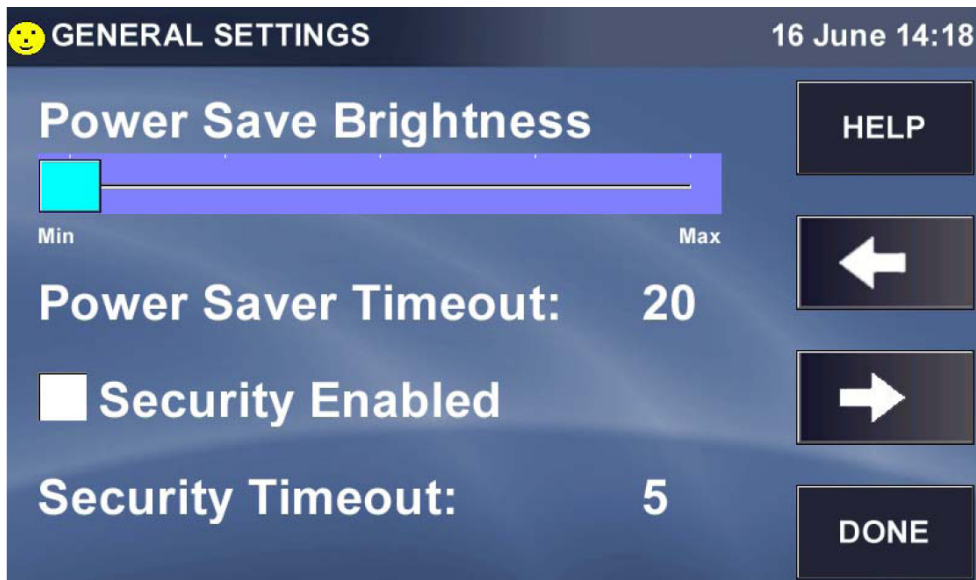

The **Power Save Brightness** setting governs the degree of brightness or dimness that you see onscreen when the screen enters Power Save mode.

- ▶ Click inside the **Power Save Brightness** bar to move the light blue marker to any of 5 choices ranging between **Min** and **Max**.

This sample screen shows the marker moved from **Min**, where it was previously, to midrange:





The **Power Saver Timeout** is the time after which, if the display remains untouched, the screen will dim.

- ▶ Press *Power Saver Timeout* to set or reset the timeout duration. In the **SET POWER SAVE MINUTES** keypad screen that opens:

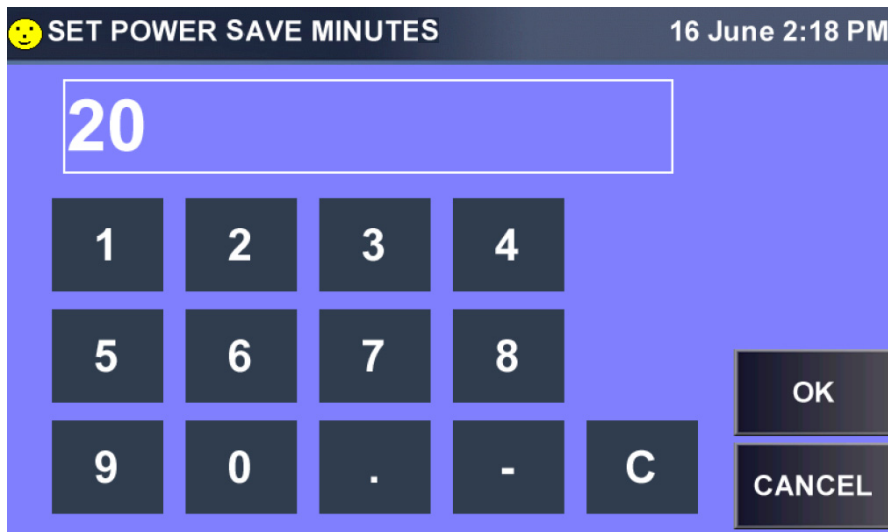

- ▶ Input the desired number of minutes, then press *OK*.
- ▶ If **Security** is not enabled (the check box is empty, as shown in sample **GENERAL SETTINGS** screen), press **Security** or press inside the checkbox to enable it:

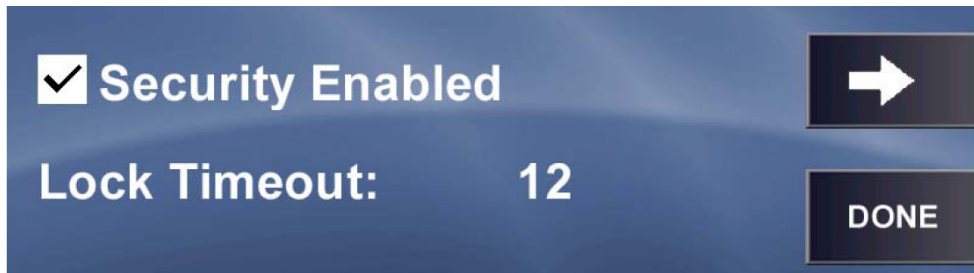

If you do not have Administrative authority, you will see this screen:

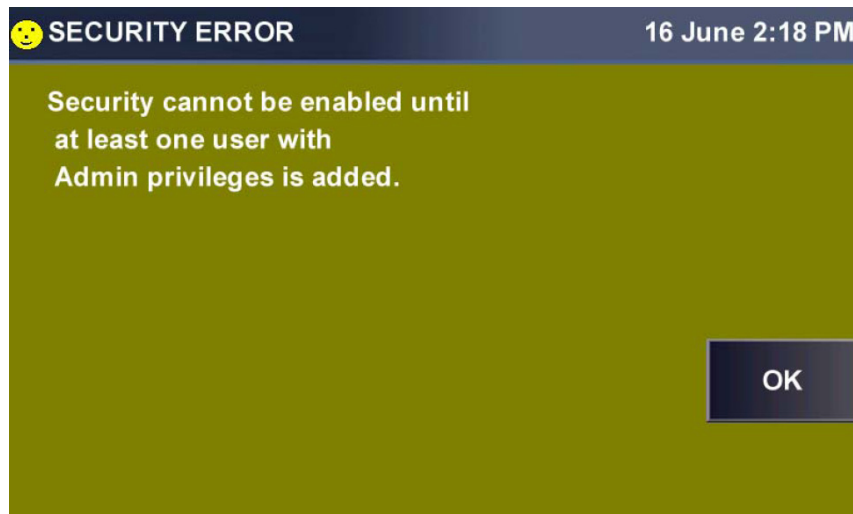

- ▶ Press the *OK* button to acknowledge this message to return to the **GENERAL SETTINGS** screen.



When Security is enabled, the padlock icon on the SUMMARY and STATUS screens will be closed, and users will have access to only the SUMMARY and STATUS screens. In fact, the MENU button in the SUMMARY screen will have changed to a VIEW button.

The Lock Timeout is the time of screen idling after which, when Security is enabled, the system will lock itself. The padlock will change from unlocked to locked and a user with Administrative privileges (see *USER ACCESS screen on p. 54*) must log on to unlock the system.

- ▶ Press Lock Timeout to set or change the duration.
- ▶ In the **SET LOCK TIME MINUTES** keypad that opens, press the keys to input the desired time, then press the *OK* button:

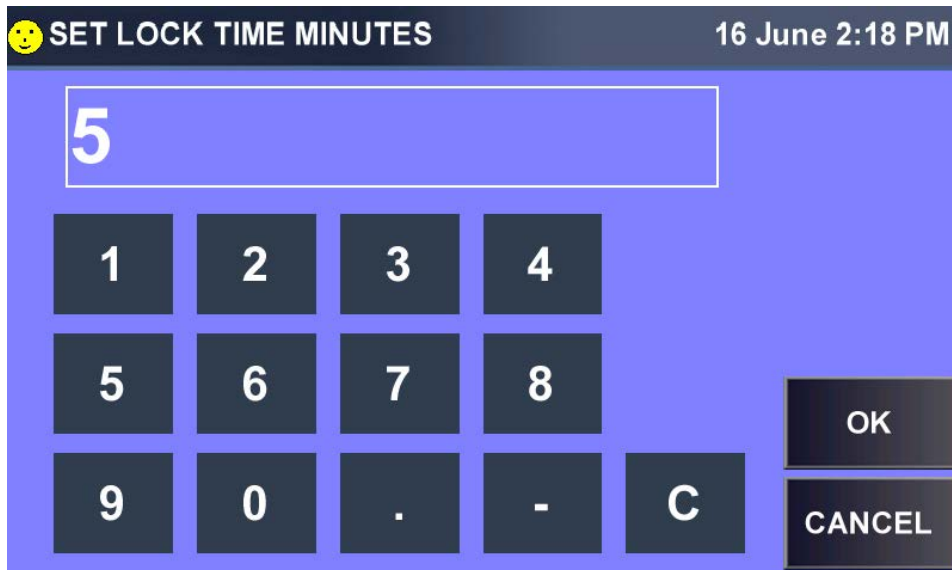

- ▶ When you return to the **GENERAL SETTINGS** screen, press the *RIGHT* arrow button to open the next **GENERAL SETTINGS** screen:

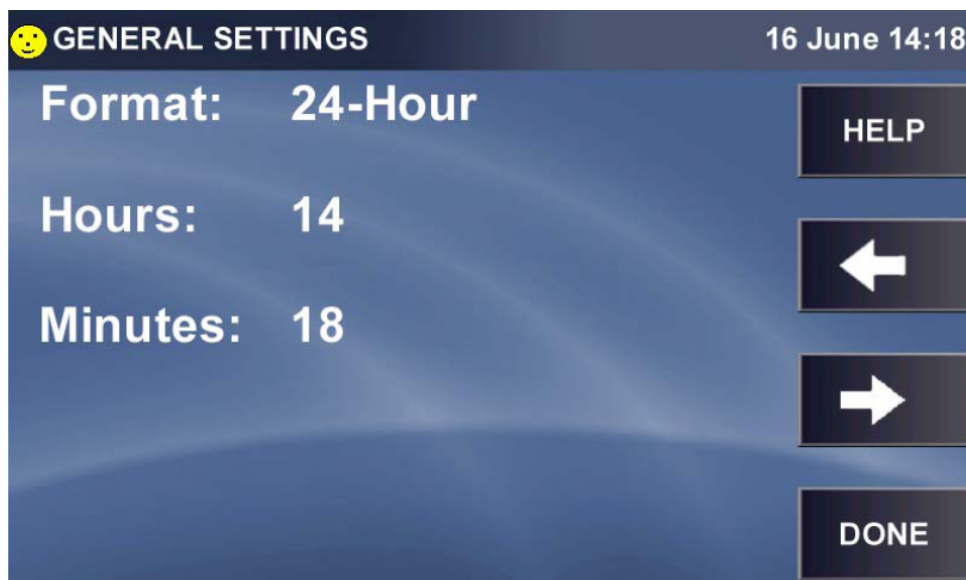

In the above example, the display is set to 24-hour (military) time. If you press the Format line, it will automatically toggle to 12-Hour:

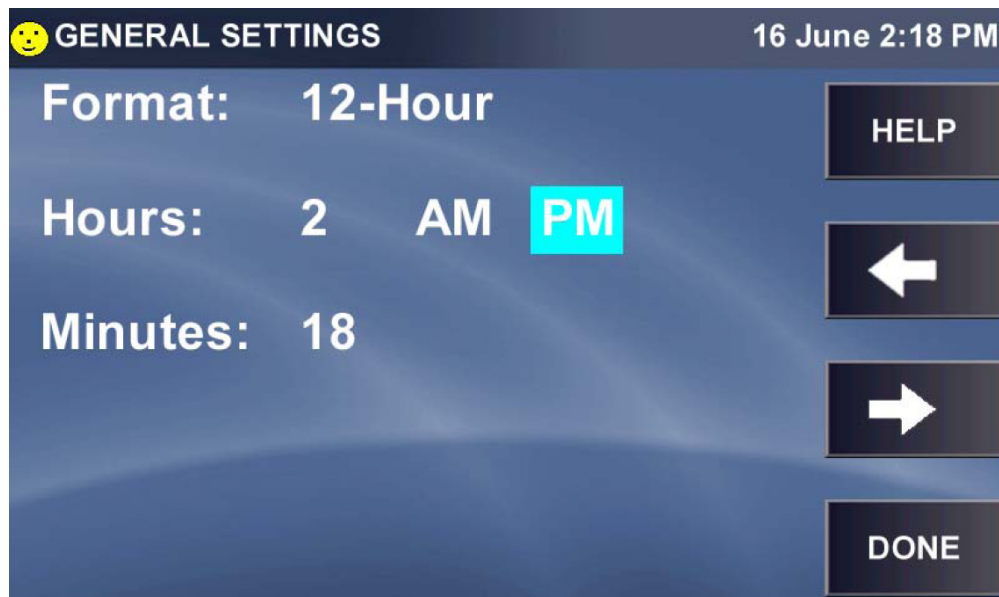

- ▶ To change from **PM** (highlighted) to **AM**, press **AM**.
- ▶ To change the Hours, press either Hours or the number (2 in this case) and use the popup keypad to update the hour, then press the *OK* button to save your update.
- ▶ To change the Minutes, press either Minutes or the number (18 in this case) and use the popup keypad to update the hour, then press the *OK* button to save your update.
- ▶ Press the *RIGHT* arrow button to open the next **GENERAL SETTINGS** screen:

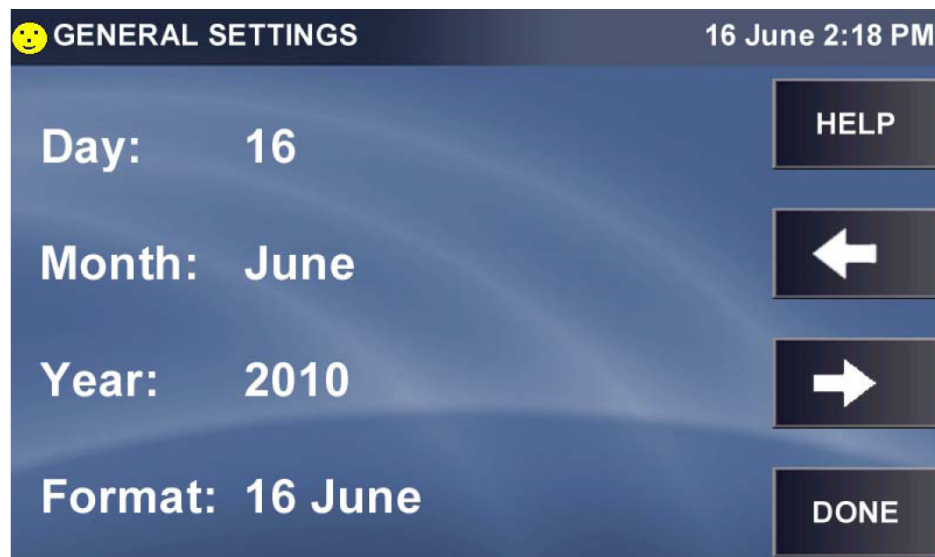

- ▶ Press **Day**, **Month** and/or **Year** and use the popup keypad in each case to correct the date, which is displayed in the upper righthand corner of the screen.
- ▶ To change the **Format** of the date (shown in European style), press anywhere in the Format line to open the **SET FORMAT** screen:



- ▶ Press the date format you prefer, for example June 16, then press the *OK* button to return to the date settings screen. Note that the date format in the top right corner has changed:

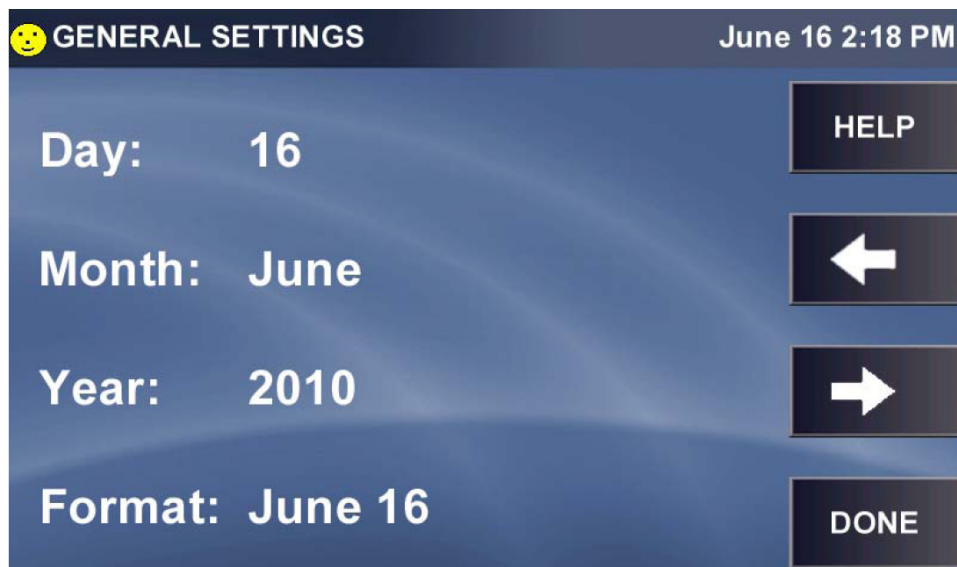

- ▶ After you have made all desired changes to the settings, press the *DONE* button to return to the **MENU**.

### 5.5.8 USER ACCESS screen



Fig. 5-7: Users button

- ▶ Press the *Users* button to open the **USER ACCESS** screen:



- ▶ Press the *NEW* button to add a User. In the **NEW USER NAME** keypad:



- ▶ Use the keypad to choose numbers and/or letters. For buttons with one number and several letters, you will need to press repeatedly to input the desired character (they appear in sequence; for example, press

2, ABC button once to display 2 in the edit field; a second time to display A; press it again for B; and a fourth time for C. If you press it again, it will cycle back to 2.

- ▶ Move to the next key to input the next number or letter.



A user name may be up to 8 characters in length.

If you need two or more items from the same key, wait a few seconds after selecting the first, then press the key again as needed to select the next item.

In this sample screen, we pressed the 3, DEF key three times to cycle through 3, then D, to E:



- ▶ When the **User Name** is complete, press the *NEXT* button. The name will be saved, and the **NEW PASSWORD** keypad will open:

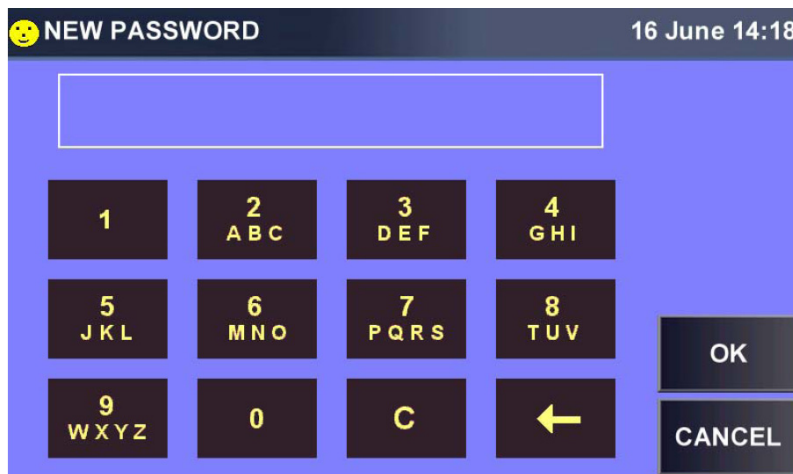

The keys work the same way here as in the **NEW USER NAME** screen.

- ▶ When the desired Password is in the field, press the *OK* button to save it for the new user and to return to the **USER ACCESS** screen.
- ▶ If the Password is inappropriate (for example, too short), you will be prompted with an **ILLEGAL PASSWORD** warning screen:

**Operation**

New Brunswick™ S41i  
English (EN)

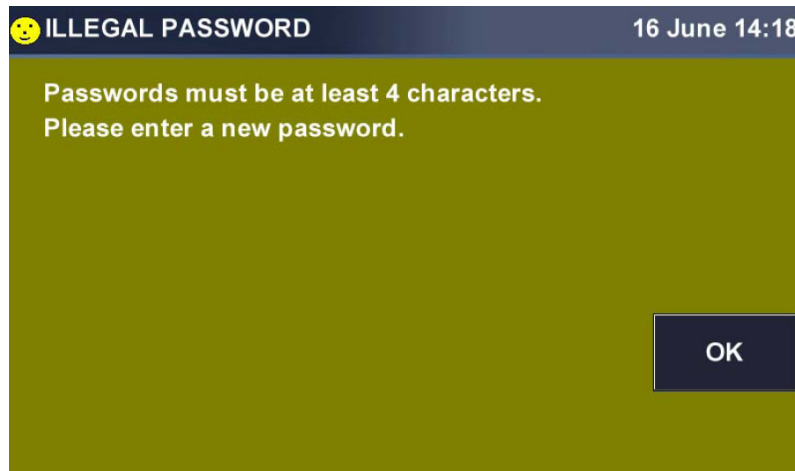

- ▶ Press the *OK* button to return to the **NEW PASSWORD** keypad and input an appropriate password.
- ▶ When the desired Password is in the field, press the *OK* button to save it for the new user and to return to the **USER ACCESS** screen.  
You may need to set privileges for one or more users:
- ▶ Press the user's name to highlight that row, then press the *EDIT* button to open the EDIT USER screen:

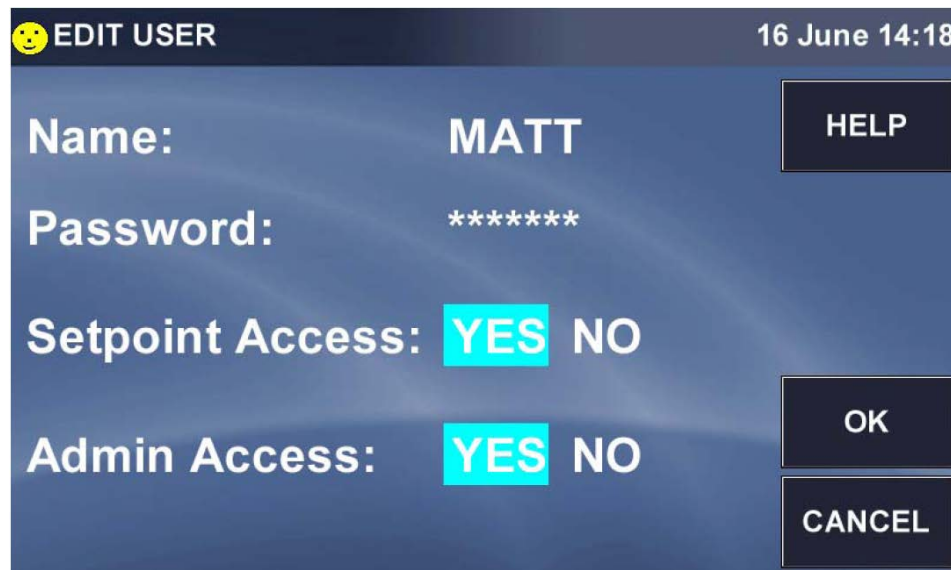

- ▶ Press Name: to open the **CHANGE USER NAME** screen, make changes, then press the *OK* button to return to the **USER ACCESS** screen.
- ▶ To make more edits to this or any other user's information, press the user's name to highlight the row, then press the *EDIT* button.
- ▶ **PASSWORD** screen; press the YES or NO for **Setpoint Access** and/or **Admin Access** to select the desired settings, then press the *OK* button to return to the **USER ACCESS** screen.



Setpoint Access gives the user access to edit setpoints.  
Admin Access allows access to all user functions.



**To remove a user from the system:**

- ▶ Highlight the name, press the *DELETE* button, then press the *OK* button. You will be prompted to indicate whether you are sure about this deletion:

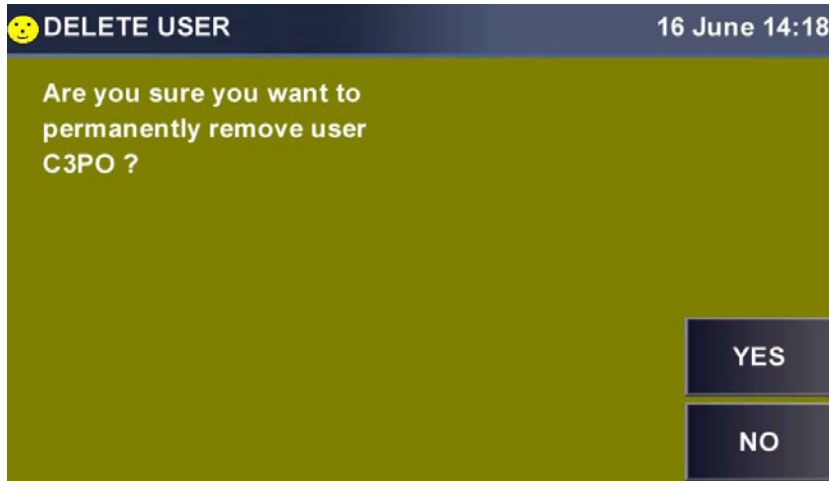

- ▶ Press the *YES* or *NO* button as appropriate. You will return to the **USER ACCESS** screen.
- ▶ Press the *DONE* button when you have finished to return to the **MENU** screen.

### 5.5.9 COMMUNICATIONS screen



Fig. 5-8: Communications button

- ▶ Press *Communications* button to open the **SET COMMUNICATIONS** screen:

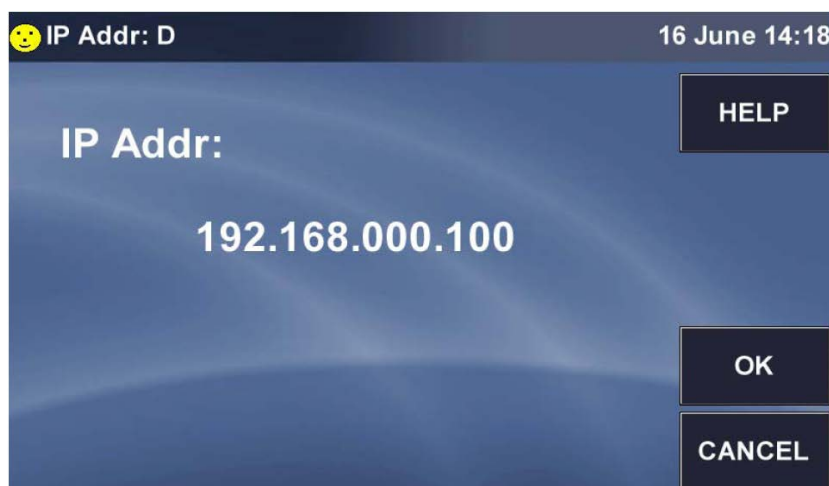

**Ethernet** is the default mode, which is why the IP Address is displayed.

### If you need to change the IP address

- ▶ press that line to open a keypad for the first three digits:

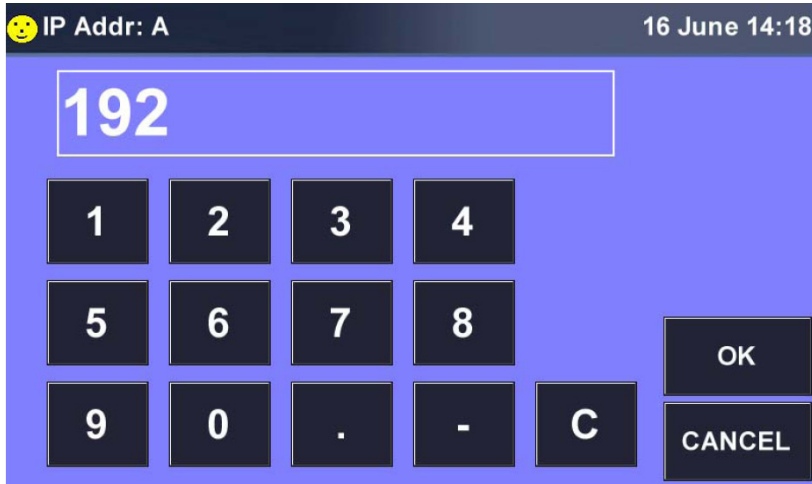

- ▶ Use the *OK* button either to reset each of the four sets of digits (Address A, B, C and D) or to cycle through each set and change any as needed.
- ▶ Press the button in the **SET COMMUNICATIONS** screen at any time to return to the **MENU** screen.

## 5.6 MENU 2 Screen

- ▶ To open the **MENU 2** screen, press the *RIGHT* arrow button in the **MENU 1** screen:



If any option shown above is not present on your system, the button will not appear in your **MENU 2** screen.

### 5.6.1 SERVICE screen



Fig. 5-9: Service button

Use of the *SERVICE* button and the Service screen it represents is reserved for authorized service technicians and therefore requires a Passcode. You will not have (or need) access to this screen.

### 5.6.2 DIAGNOSTICS screen



Fig. 5-10: Diagnostics button

**i** The only time you will need to consult this screen is during a conversation with your authorized service technician, who may ask you to report information from the system’s diagnostics.

▶ Press the *Diagonstics* button to open the 1<sup>st</sup> page of the **DIAGNOSTICS** screen:



Note that the title of the screen indicates that there are 11 pages to this screen. Press the *RIGHT* button to scroll through the next page(s) as needed. When you have finished reviewing the screens, press the **DONE** button to return to the **MENU**.

### 5.6.3 MAINTENANCE screen



Fig. 5-11: Maintenance button



When connecting a USB device, the device must be a FAT32 file system. Filing systems such as NEST will not work properly.

Press the *Maintenance* button to open the *MAINTENANCE* screen:



#### 5.6.3.1 Update Controller Firmware

Firmware updates are available on our website.

- ▶ If wish to **Update Controller Firmware**, press that line to select it:



Then press the *NEXT* button. You will be prompted with this screen:



- ▶ Do as instructed to download the update. The USB port is located under the display bezel.
- ▶ Press the *DONE* button to return to the **MAINTENANCE** screen.

If you have finished working in the **MAINTENANCE** screen, press the *DONE* button to return to the **MENU**.

### 5.6.3.2 Update Display Firmware

Firmware updates are available on our website.

- ▶ If you wish to **Update Display Firmware**, press that line to select it:



- ▶ Then press the *NEXT* button; you will be prompted with this screen:



- ▶ Do as instructed to upload the User Interface binary update files. The USB port is located under the display bezel.

- ▶ Press the *DONE* button to return to the *MAINTENANCE* screen.

When you have finished working in the **MAINTENANCE** screen, press the button to return to the **MENU**.

### 5.6.3.3 View sensor trends

The **View Sensor Trends** screens display up to 72 hours of data. If a problem should occur in operation, your authorized service technician may ask you to access data from one or more of the sensors, to export it via USB drive and to send the file to Eppendorf for evaluation. This section will explain how to access, export and, when appropriate, clear this data.

- ▶ If you are prompted by your authorized service technician to *View Sensor Trends* in the **MAINTENANCE** screen, press this line to select it:

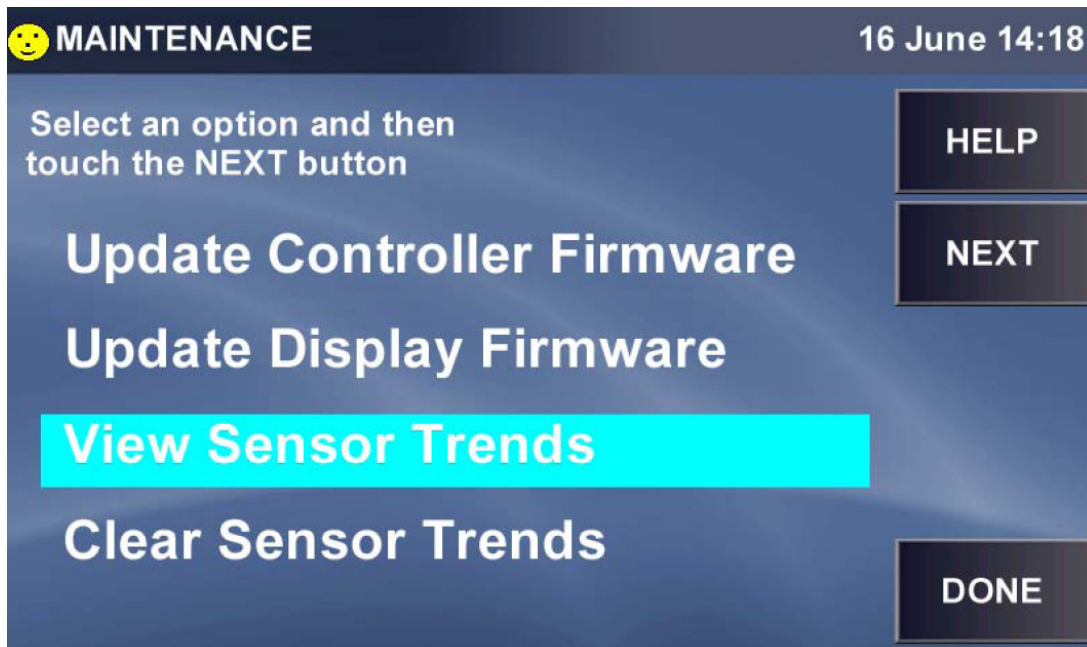

- ▶ Press the *NEXT* button to open the first of five *DIAGNOSTIC TRENDS* screen:

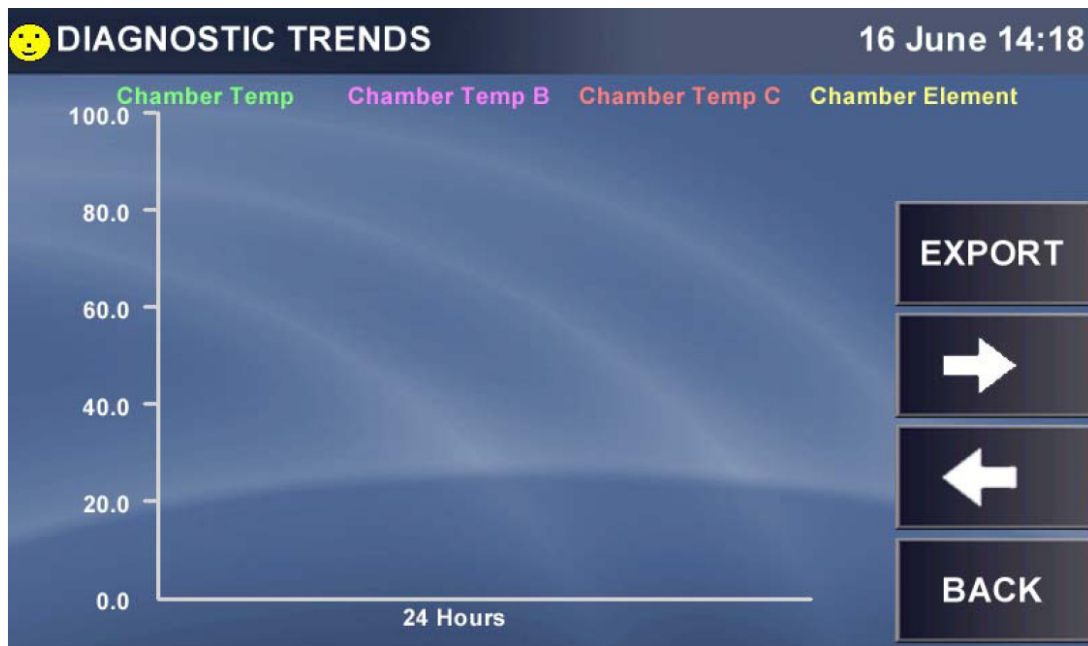

These sample screens do not display any logged data, but your screens should be complete with data.

Take special note of the color of each sensor parameter at the top of the screen, to identify its related trend on the graph.

- ▶ If the desired information is not displayed here, press the *RIGHT* arrow button to scroll through the additional screens.
- ▶ At any time you can press the *LEFT* button to return to the previous screen.
- ▶ As with the Event Graph, at any time you can press the X or Y axis to change the display parameters of these trends.
- ▶ At any time you can press the *EXPORT* button to save diagnostic data to a USB memory stick/flash drive. You will be prompted with the following screen:



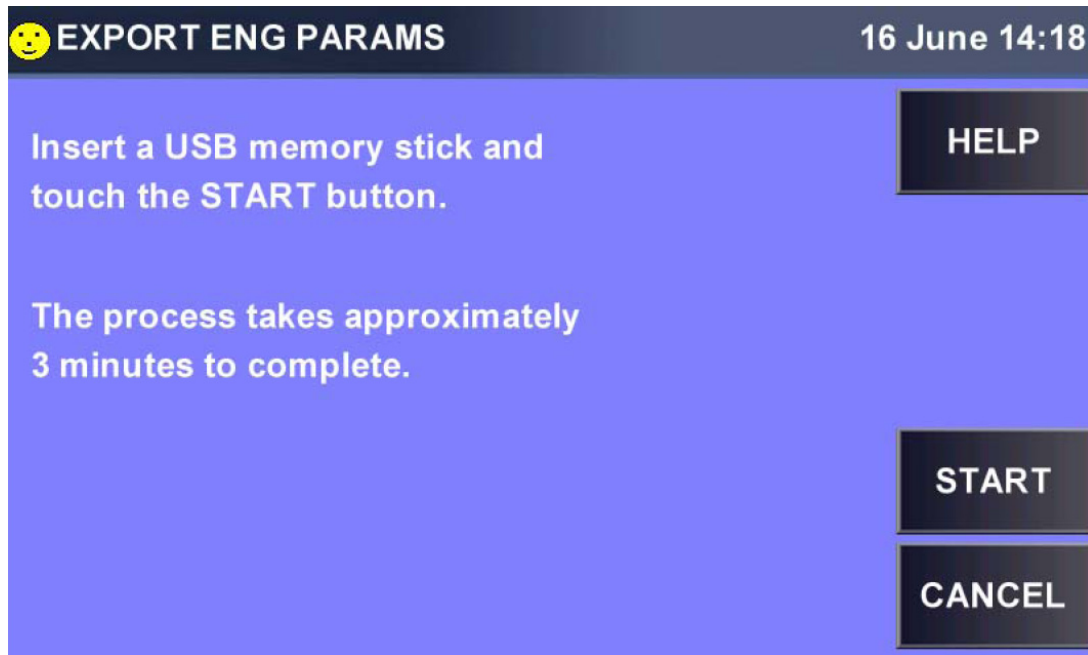

- ▶ Follow the instructions. When you press the *START* button, this screen will appear:

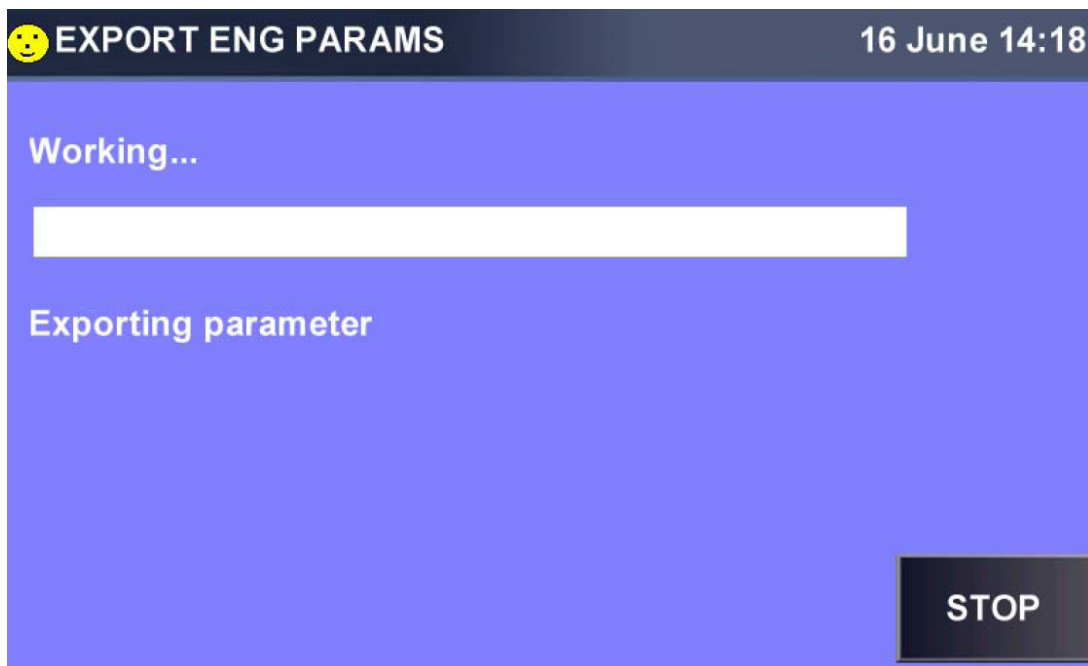

- ▶ When you have finished working in the **MAINTENANCE** screen, press the *DONE* button to return to the **MENU**.

#### 5.6.3.4 Clear sensor trends

- ▶ If you wish to clear all the data logged in the diagnostic sensor trends screens, press **Clear Sensor Trends** to select it:

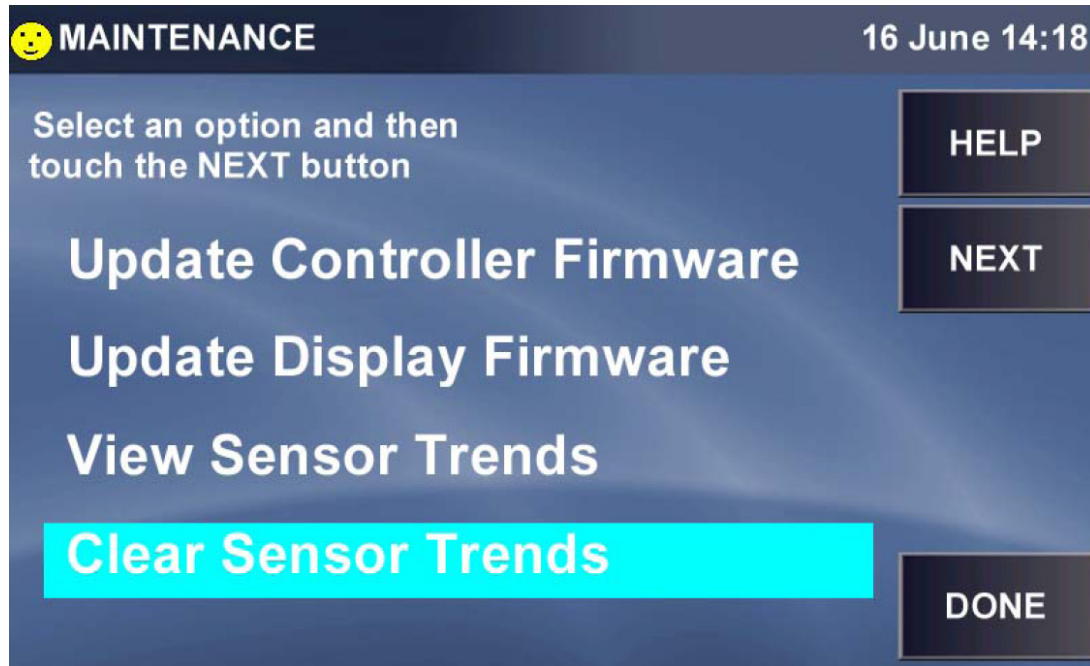

- ▶ Press the *NEXT* button and you will be prompted by this screen:

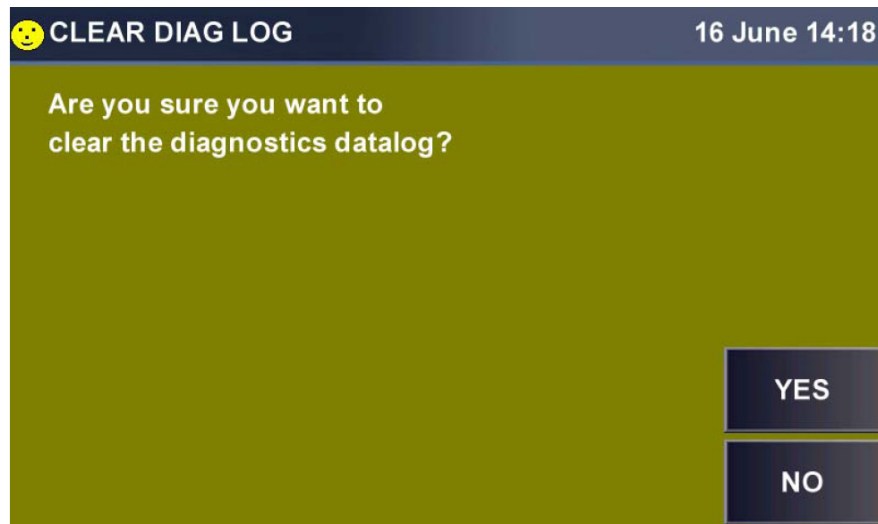

- ▶ Press the *YES* button to clear the data and return to the **MAINTENANCE** screen, or, if you change your mind, press the *NO* button to retain the data and return to **MAINTENANCE** screen.

#### 5.6.4 OPTIONS screen



Fig. 5-12: Options button

The **INSTALLED OPTIONS** screen indicates the options present in your incubator shaker.

- ▶ Press the *Options* button to open the **INSTALLED OPTIONS** screen:

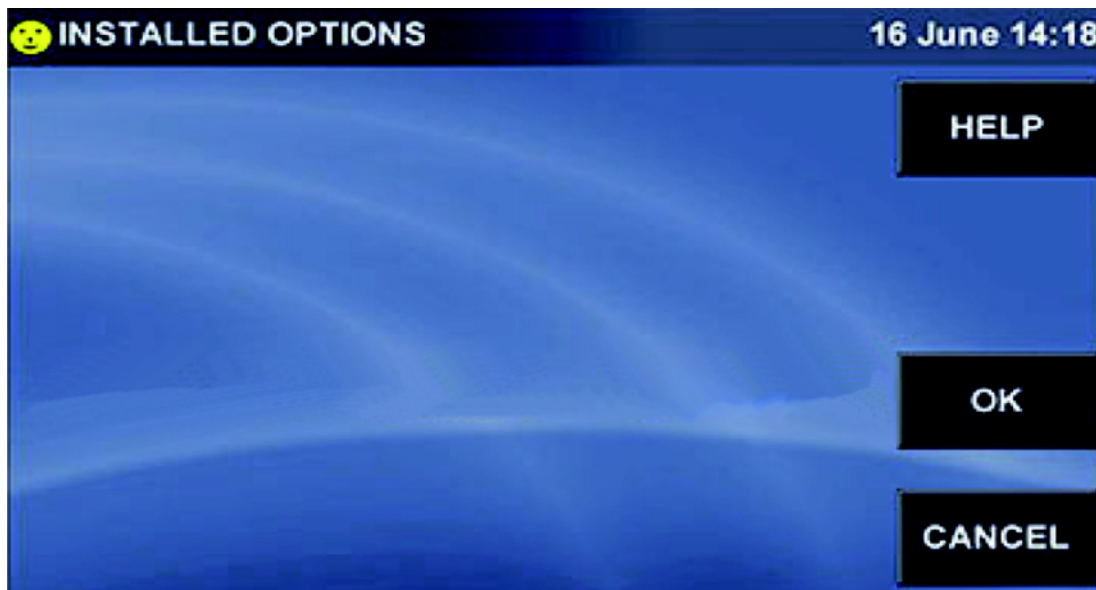

- ▶ If you have an **ON** and **OFF** choice for an option, select and then press the *OK* button to enable that selection.
- ▶ Press the *OK* button to close this screen and return to the **MENU**.

#### 5.6.5 SET CO<sub>2</sub> AUTOZERO screen



Fig. 5-13: CO<sub>2</sub> Autozero button

The CO<sub>2</sub> Auto-Zero feature tests the CO<sub>2</sub> sensor by pumping outside air (atmosphere) into the CO<sub>2</sub> sensor's measuring area, to displace the chamber air at that location. This process take only a few minutes. The sensor is re-referenced to the CO<sub>2</sub> level from the atmosphere before the chamber air mixes in with the atmosphere and normal CO<sub>2</sub> control resumes.

- ▶ Press the *CO<sub>2</sub> Autozero* button to open the **SET CO<sub>2</sub> AUTOZERO** screen:



- ▶ Press **Frequency** to reset the occurrence of CO2 Autozero: press once for Daily, a 2<sup>nd</sup> time for Weekly, press again for Bi-Weekly, a 4<sup>th</sup> time for Monthly, then back to OFF.
- ▶ Press **Start Time** to open this screen:

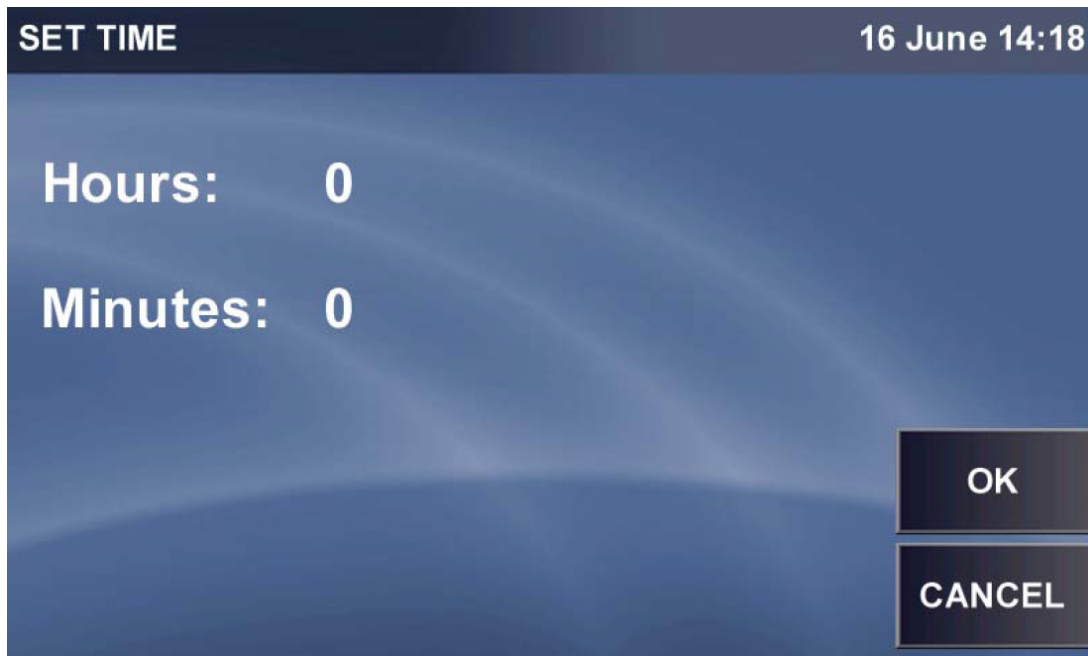

- ▶ Press **Hours**, then use the **SET HOUR** popup keypad to enter the Hour time:

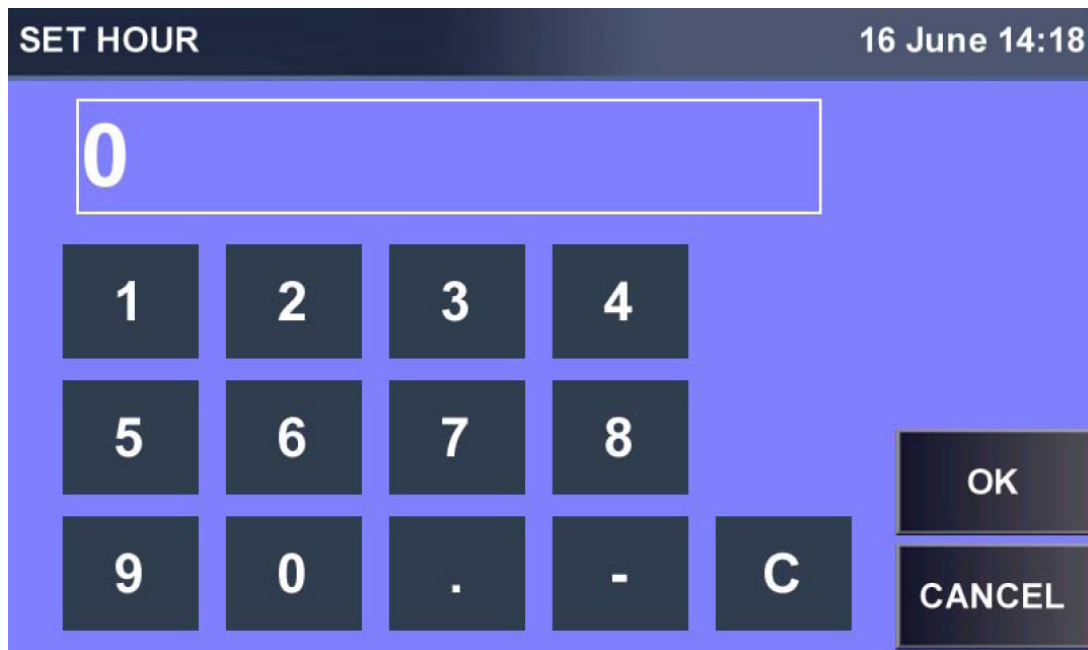

- ▶ Press the *OK* button to save your input; now do the same for the minutes.
- ▶ When your selections are made in the **SET TIME** screen, press the *OK* button to return to the **SET CO2 AUTOZERO** screen.
- ▶ To start a CO2 Autozero at this time, press the *RUN AZ* button. This screen will open:

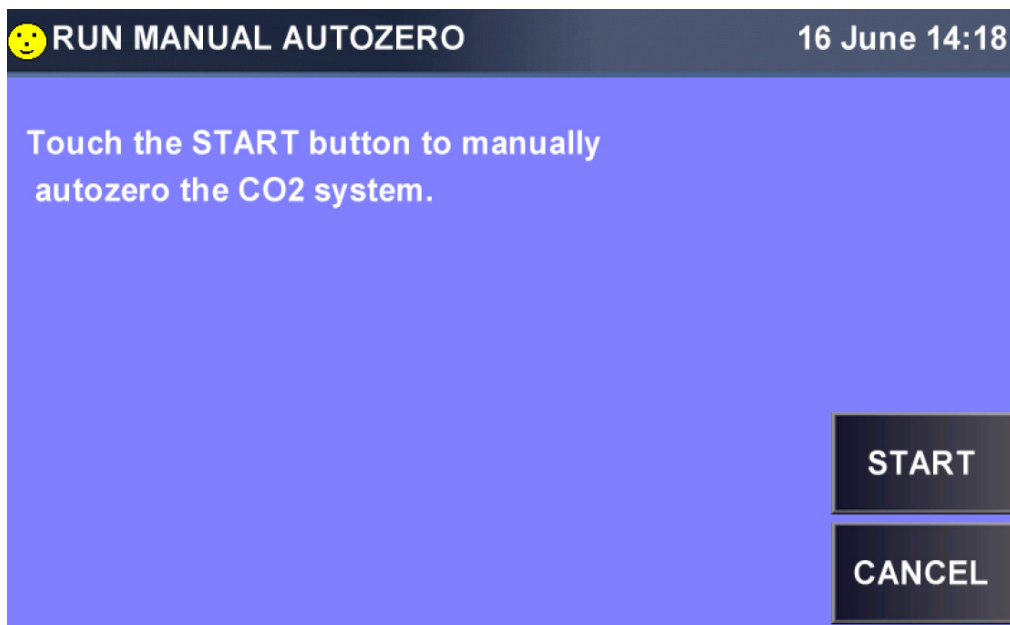

- ▶ Press the *START* button to confirm your wish to run the program. This is called a manual autozero because it is being initiated outside the automatic settings.  
The autozero will begin, and this screen will track the progress of the procedure:

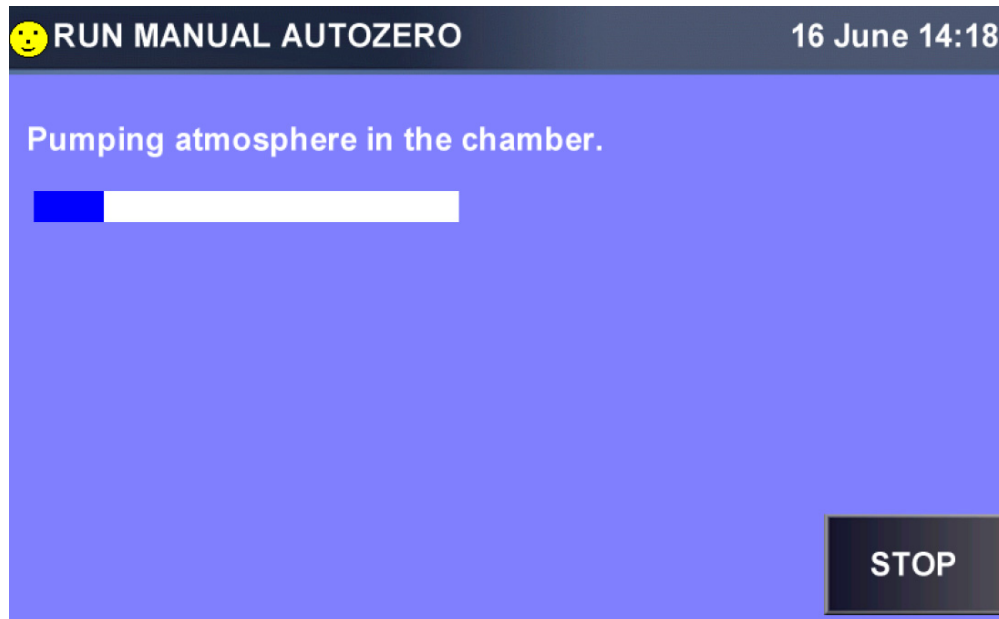

When the long white box is fully blue, indicating the atmosphere pumping has been completed, the screen will change to indicate "CO2 Autozero is complete. Result: Completed OK."

- ▶ To abort the procedure at any time, press the *STOP* button.

If you do so, this screen will appear:

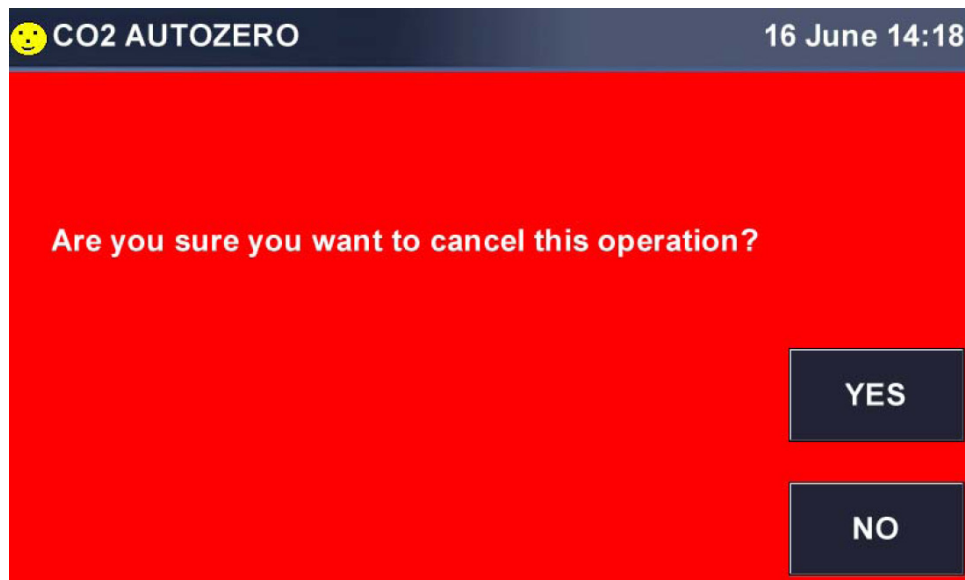

- ▶ To confirm that you wish to cancel the procedure, press the *YES* button. The following screen will appear:

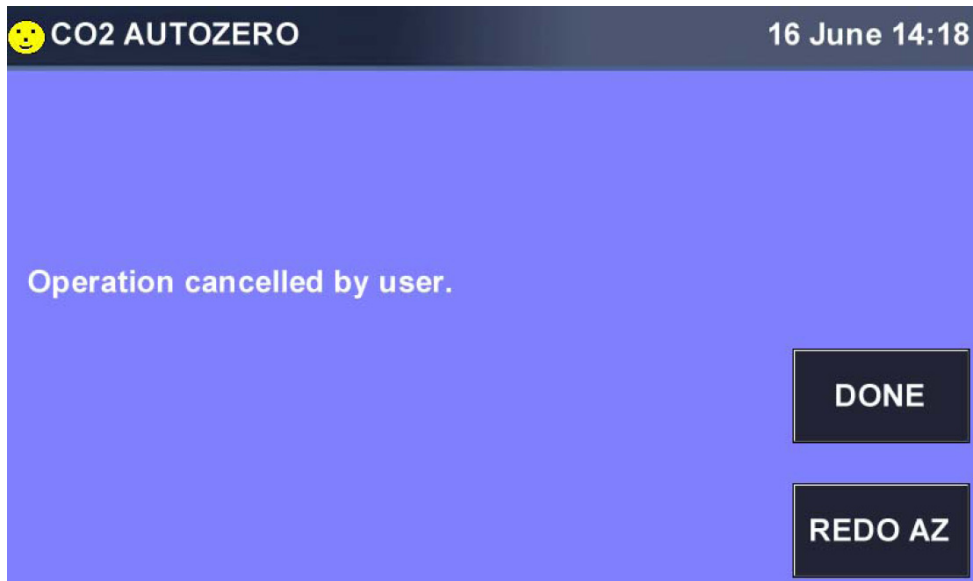

Your options are to press the *REDO* button to begin the procedure again or to press the **DONE** button to return to the **SET CO2 AUTOZERO** screen.

- ▶ Press the *OK* button to return to the **MENU**.

### 5.6.6 DISINFECTION screen

For more info on High Temperature Disinfection (see *High temperature disinfection on p. 14*).



Fig. 5-14: Disinfection button

- ▶ To run the High Temperature Disinfection program , press the *Disinfection* button.
- ▶ In the screen that opens:

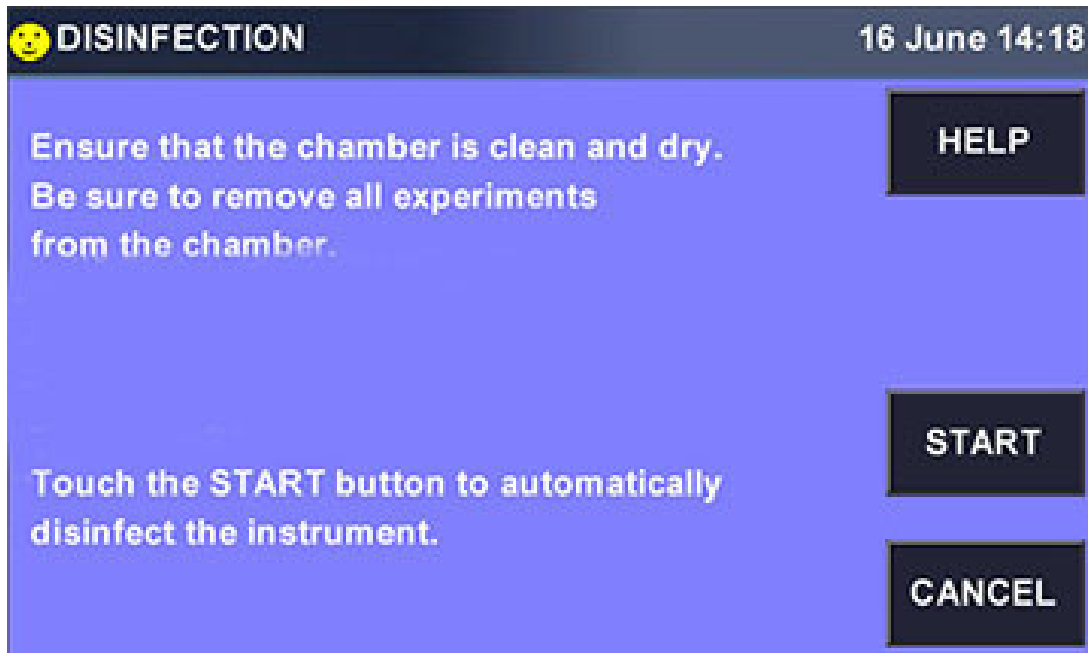

Follow the on-screen prompts. (Press the *CANCEL* button if you are not yet ready to disinfect, or if you decide not to proceed.)

If you press **START**, the following screen will chart the progress of the disinfection program:

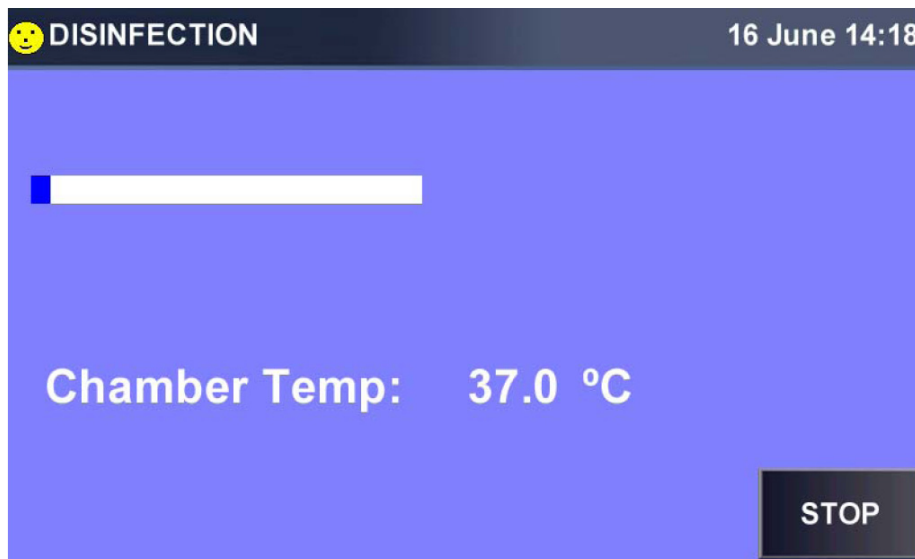

You can press the *STOP* button at any time to stop the program.  
If the disinfection is aborted, you will see this screen:



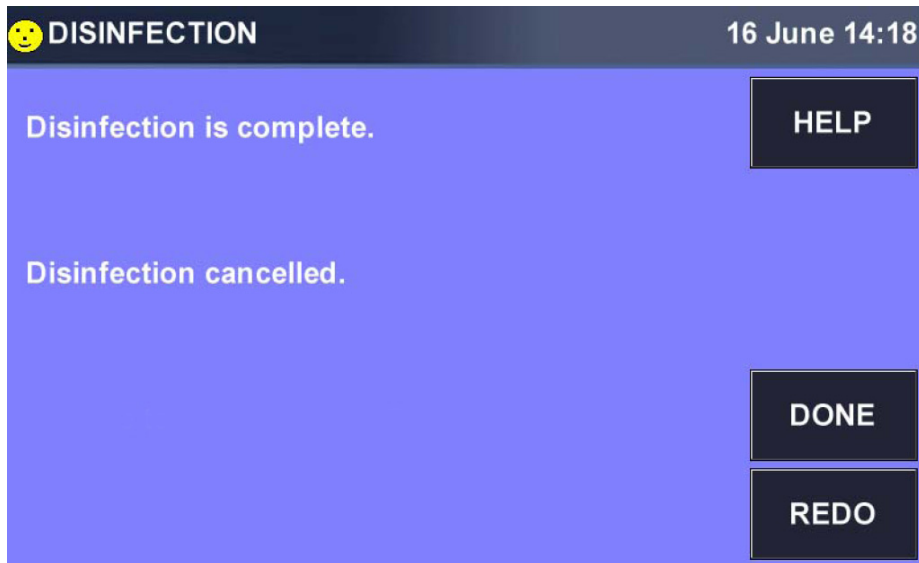

- ▶ To restart the program, press the *REDO* button.
- ▶ To acknowledge the process is complete, press the *DONE* button; you will return to the **MENU** screen.



## 6 Troubleshooting

### 6.1 General errors

Technical faults may be triggered by faults such as a power failure or power fluctuations. Therefore, it is usually sufficient to briefly switch off the device and switch it back on after approx. 10 seconds. Check the cable connections if necessary. If the error occurs again, contact Eppendorf Service.

### 6.2 Mains/Power Interruption and Fault Interruption

In the event of a mains/power failure, S41i incubator shakers are equipped with an **automatic restart** function. The incubator shaker's non-volatile memory retains all stored information.

If the incubator shaker was in operation prior to the mains/power interruption, the incubator shaker will begin to operate at its last entered setpoints. The smiling icon will be green to indicate automatic restart until you touch the screen; then it will turn yellow. The alarm display will flash, indicating that a mains/power interruption has occurred; you will need to acknowledge the alarm.

In the unlikely event of a mechanical shaking fault interruption, the S41i incubator shaker display will flash an alarm and warn the user with an audible signal, indicating an alarm has occurred. In this mechanical shaking fault interruption, the shaker **will not restart** the shaking function.

The incubator shaker will not operate shaking until the alarm is muted, acknowledged, and shaking is manually restarted from the touch screen at the last entered setpoints.

Problem	Possible cause	Solution
CO <sub>2</sub> pressure below warning level	CO <sub>2</sub> cylinder is almost empty.	Check CO <sub>2</sub> supply. Exchange CO <sub>2</sub> gas cylinder and adjust gas supply. Check gas connection on disconnection or leakage, e.g., in-line gas filter, gas connection.



## 7 Maintenance

### 7.1 Routine Maintenance

#### 7.1.1 General notes

To ensure that chamber conditions remain as stable as possible, be sure to minimize the length of time that the door is open. When you open the door, wipe off any small drops of condensate that may have formed on the inner seal. This will avoid a build-up of condensation.

If you are using the humidity tray for humidification, be sure to follow the indications provided (see *Electrical Connections on p. 22*) and (see *Using the Water Trays on p. 31*).



There is no need to remove the top panel for normal maintenance or servicing, so if you have two incubator shakers stacked, the upper incubator shaker does not have to be moved when you are servicing the lower incubator shaker.

#### 7.1.2 Daily checks

1. Check that the temperature and CO<sub>2</sub> levels are reading within specification.
2. Check that gas supply lines have inline regulators, that they are properly installed and functioning.
3. Check the reserve pressure in the CO<sub>2</sub> cylinder (normally 725 psi or 50 bar when full). The design of the incubator shaker ensures very low consumption of CO<sub>2</sub>: during normal working conditions, a typical large cylinder should last approximately 12 months (frequent door openings will deplete the supply more rapidly). If there is a significant drop at the cylinder pressure of 725 psi or 50 bar, it means that the cylinder is almost empty and should be replaced. Ensuring that there are no leaks at any of the connections will ensure a greater lifetime to the CO<sub>2</sub> supply and will help avoid accidentally running out of CO<sub>2</sub>.
4. Check the **ALARM** and **EVENT LOG** screens for any alarms or events that may have occurred overnight.

#### 7.1.3 Weekly checks

- ▶ If you are using them for humidification, check the humidity trays and refill them as needed. Be careful not to exceed the maximum volume of 250 mL per pan. The use of warm water (~ 37.0 °C) will ensure a rapid return to optimum chamber conditions.

#### 7.1.4 Monthly check

- ▶ Auto-Zero the CO<sub>2</sub> system at least once monthly to ensure that the CO<sub>2</sub> level is correct.
- ▶ We recommend monthly replacement of the water in the humidity trays. Clean the trays at the same time.
- ▶ If required, you can take a sample of the gas inside the chamber using the CO<sub>2</sub> sample port, and check it using a CO<sub>2</sub> gas analyzer (see *CO<sub>2</sub> Sampling with Analyzer on p. 78*).

#### 7.1.5 Other checks

- ▶ At least once every six months, check tubing for wear and for leaks. Replace as needed.

### 7.1.6 CO<sub>2</sub> Sampling with Analyzer

We recommend that you perform a CO<sub>2</sub> Auto-Zero prior to sampling.

The CO<sub>2</sub> sample port is located on the righthand side of the incubator shaker, near the top.

If you conduct a sampling, please ensure the following:

- ▶ Turn off the CO<sub>2</sub> gas by re-programming the setpoint for CO<sub>2</sub> to 0.0 % to prevent CO<sub>2</sub> from being injected into the chamber and giving a false reading.
- ▶ A flow rate ≤ 0.5 liters/minute is used to take a sample.
- ▶ The door is kept closed to minimize heat loss.
- ▶ Remember to reset the CO<sub>2</sub> setpoint to the desired level after sampling.

We also recommend that you Auto-Zero the CO<sub>2</sub> system at least once every month to ensure that CO<sub>2</sub> level is correct (see *Monthly check on p. 77*).

## 7.2 Cleaning



### **DANGER! Electric shock.**

- ▶ Switch off the device and disconnect the mains/power plug before commencing any service or cleaning operations.



### **WARNING! Risk of injury to personnel or damage to equipment**

- ▶ While cleaning or disinfecting/decontaminating the chamber, take care not to break small sensors/other parts or destroy your protective gloves by wiping with too much power.



### **WARNING! Risk of injury to personnel**

- ▶ While cleaning, disinfecting/decontaminating or preparing the chamber, take care not to damage your protective gloves at small sensor parts extending into the chamber.



### **NOTICE! Corrosion due to aggressive cleaning agents and disinfectants.**

- ▶ Do not use any corrosive cleaning agents, aggressive solvents or abrasive polishes.
- ▶ Do not incubate the accessories in aggressive cleaning agents or disinfectants for longer periods.



Do not clean the device with formaldehyde.

1. Routinely clean the exterior of the device by wiping it over with a soft cloth, moistened with soapy water.
2. Rinse the soap from the cloth in clean water, and wipe the exterior surfaces again.

## 7.3 Disinfection/Decontamination

The recommended disinfecting agent for use with the incubator shaker is a solution of 70 % isopropanol (isopropyl alcohol) and 30 % distilled water.

Be sure to follow appropriate safety regulations while you are using the alcoholic solution. To best protect yourself, your incubator shaker and your work area, follow these instructions:



### **DANGER! Electric shock due to the ingress of liquid.**

- ▶ Switch off the device and disconnect it from the mains/power line before starting cleaning or disinfection.
- ▶ Do not allow any liquids to penetrate the inside of the housing.
- ▶ Do not perform a spray clean/spray disinfection on the housing.
- ▶ Only reconnect the device to the mains/power line when it is completely dry, both inside and outside.



### **WARNING! Infection by contaminated material.**

There may be contaminated material on the device and accessories. You may become infected by contaminated material.

- ▶ Find out more about the risk of contamination before starting work.
- ▶ Check the decontamination certificate of the device.
- ▶ Work on decontaminated devices only.
- ▶ Wear your personal protective equipment (protective gloves, protective goggles).



### **CAUTION! Risk of potential harm to personnel**

- ▶ As a routine precaution, wear protective gloves.
- ▶ Be sure to adequately ventilate the work area as you disinfect, to avoid the formation of potentially explosive alcohol vapors.



### **CAUTION! Risk of potential harm to personnel**

- ▶ If hazardous material is spilt onto or into the equipment, appropriate decontamination procedures and safety practices must be employed.



### **NOTICE! Risk of material damage**

- ▶ Protect all electrical connections from contact with the alcohol solution.



### **NOTICE! Risk of equipment damage and/or hazard**

- ▶ Never use any of the following substances to clean the stainless steel: Sodium Azide, Aqua Regia, Iodine, Ferric Chloride, Sodium Hypochlorite, or Sulphuric Acid.
-

**Maintenance**

New Brunswick™ S41i  
English (EN)

1. Program 0.0 % CO<sub>2</sub> and switch off the incubator shaker. Unplug the incubator shaker from the mains/ power supply.
2. Dampen a clean cloth with the alcoholic solution and wipe down all external surfaces, taking care to keep the alcoholic solution from coming into contact with any electrical outlets or assemblies.
3. Remove all of the shelves, the water trays, and the removable shelf racks.

**NOTICE! Risk of equipment damage**

- ▶ Ensure that no liquid is spilled onto the white porous CO<sub>2</sub> sensor cover.
- ▶ Failure to use the colored protective cover(s) could result in damage to the sensor(s) and may affect your warranty.

4. Place the colored protective cover over the CO<sub>2</sub> sensor. Also protect any additional sensors with the colored protective cover(s) supplied.
5. Clean the water trays by rinsing them in sterile water, wiping them down with the alcoholic solution, and then rinsing them again with sterile water.
6. Wipe the inside of the chamber with the alcoholic solution, and leave it to dry completely.
7. Wipe the internal components of the chamber twice with the alcoholic solution. Wipe off excess liquid and leave it to dry completely.
8. Wipe the inner door seal with the alcoholic solution, rinse, and leave it to dry.



As you remove the CO<sub>2</sub> colored protective cover, be careful not to accidentally remove the white porous sensor cover. The cover must remain in place.

9. Ensure the colored protective cover(s) are removed from all sensor(s) and stored for safekeeping.
10. Reinstall internal components.
11. Before optionally running a high temperature disinfection, remove non-high temperature resistant accessories: Eppendorf test tube racks, Eppendorf clamps containing girdle tubes (2 L and larger clamps), sticky pads.
12. Optionally run high temperature disinfection.
13. Refill the water trays with distilled water (see *Using the Water Trays on p. 31*). When reinstalling, ensure that the trays are pushed fully back.
14. Leave the incubator shaker on overnight to allow conditions to stabilize.
15. When the incubator shaker has stabilized, carry out an Auto-zero. It may be necessary to open the glass door briefly if the CO<sub>2</sub> level is too high after performing an Auto-Zero.
16. Always consult your sales representative or contact Eppendorf AG, if there is any doubt about the compatibility of decontamination or cleaning agents with parts of the equipment or with material contained in it.



## 7.4 Shipping the device



**WARNING! Risk of personal injury due to contamination.**

People may become contaminated if you store or ship a contaminated device.

- ▶ Clean and decontaminate the device before shipping or storage.



**NOTICE! Risk of damage due to improper packaging.**

Eppendorf AG is not liable for any damage caused by improper packaging.

- ▶ Only store and transport the device in its original packaging.
  - ▶ If you do not have the original packaging, request original packing from Eppendorf AG.
- 

### Prerequisites

- The device has been cleaned and decontaminated.
  - The original packaging is available.
1. Download the "Decontamination declaration for product returns" from [www.eppendorf.com](http://www.eppendorf.com).
  2. Complete the decontamination declaration.
  3. Pack the device.
  4. Put the decontamination declaration into the packaging.  
Deliveries shipped without a decontamination certificate will not be processed.
  5. Send the device to Eppendorf AG or an authorized service center.



## 8 Transport, storage and disposal

### 8.1 Transport



**CAUTION! Risk of injury due to lifting and carrying of heavy loads**

The device is heavy. Lifting and carrying the device can lead to back injuries.

- ▶ Transport and lift the device with an adequate number of helpers only.
- ▶ Use a transport aid for transporting the device.

- If the S41i must be transported outside the building where it currently is, be sure to wrap it securely in its original packaging.
- Note the ambient conditions shown in the following table, which should be respected during transport:

	Ambient Temperature	Relative Humidity	Atmospheric Pressure
Land or water transport	-25 °C – 60 °C	10 % – 75 %	30 kPa – 106 kPa
Air freight	-20 °C – 60 °C	10 % – 75 %	30 kPa – 106 kPa

### 8.2 Storage

	Air temperature	Relative Humidity	Atmospheric Pressure
In transport packing	-25 °C – 55 °C	10 % – 95 %, non-condensing	0.7 bar (70 kPa) – 1.06 bar (106 kPa)
Without transport packing	-25 °C – 55 °C	10 % – 95 %, non-condensing	0.7 bar (70 kPa) – 1.06 bar (106 kPa)

### 8.3 Disposal

The product must be disposed of in accordance with the relevant legal provisions.

**Information on the disposal of electrical and electronic devices in the European Community:**

Within the European Community, the disposal of electrical devices is regulated by national regulations based on EU Directive 2012/19/EU pertaining to waste electrical and electronic equipment (WEEE).

According to these regulations, any devices supplied after August 13, 2005, in the business-to-business sphere, to which this product is assigned, may no longer be disposed of in municipal or domestic waste. They are marked with the following symbol to indicate this:



As the disposal regulations may differ from one country to another within the EU, please contact your supplier for more information.



**9 Technical data**  
**9.1 Weight/dimensions**  
**9.1.1 Device Dimensions**

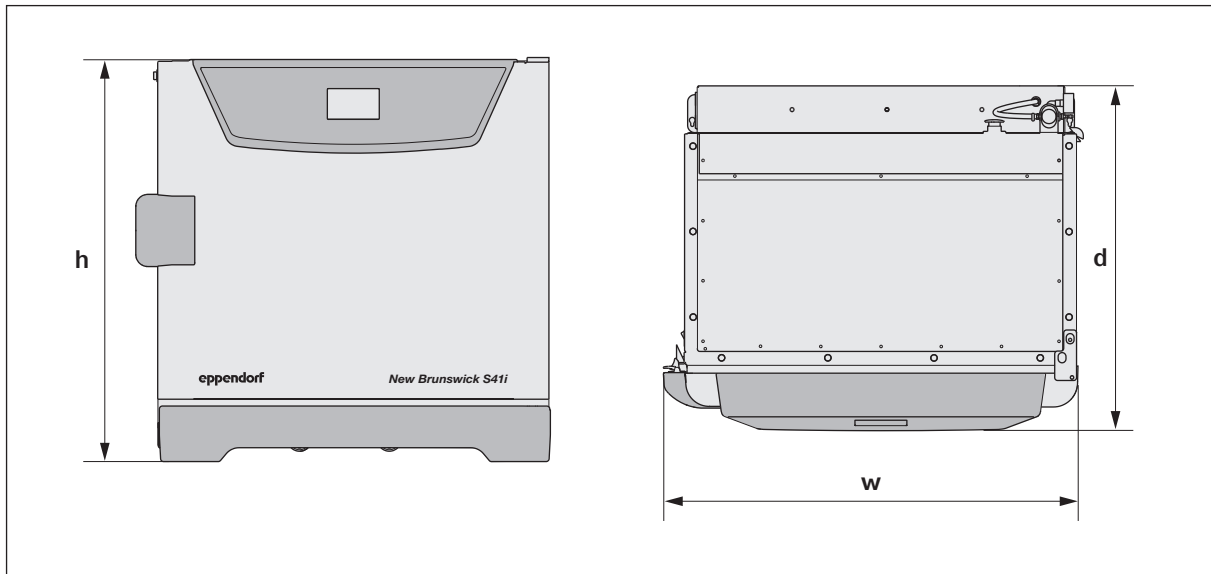

Height (h)	850 mm (33.5 in)
Width (w)	875 mm (34.4 in)
Depth (d)	730 mm (28.7 in)
Height (External, crated)	1185 mm (46.7 in)
Width (External, crated)	1000 mm (39.4 in)
Depth (External, crated)	875 mm (34.4 in), pallet included
Weight (crated)	192 kg (423 lb)
Weight (uncrated)	154 kg (340 lb), with standard features

**9.1.2 Platform dimensions**

Width	612 mm (24 in)
Depth	356 mm (14 in)

## 9.2 Power supply

### 9.2.1 Mains/electrical supply

Mains/power connection	120 V $\pm$ 10 %, 50–60 Hz 220–240 V $\pm$ 10 %, 50–60 Hz
Power consumption for 120 V	< 1800 VA
Power consumption for 220–240 V	< 1800 VA
Energy to maintain 37 °C	< 0.1 kWh
Overvoltage category	II (IEC 61010-1)
Protection class	I
Max. power consumption during normal application	
120 V	< 1300 VA
220–240 V	< 1300 VA
Max. power consumption during high temperature disinfection	
120 V	< 1200 VA
220–240 V	< 1200 VA

## 9.3 Ambient operating conditions

Ambient Temperature	15–28 °C
Storage Temperature	10–50 °C
Altitude limit	2000 m (2187 yd)
Relative humidity	20–80 %
Pollution degree	2

## 9.4 Application parameters

### 9.4.1 Speed

Speed (with 2.54 cm (1 in) orbit)	25–400 rpm
Speed (with two incubator shakers stacked)	25–250 rpm
Control accuracy	$\pm$ 1 % full scale

### 9.4.2 Temperature management

- Measurements of chamber and door temperature are taken by 6 RT (resistance temperature) curve-matched sensors with a sensitivity of 0.01 °C.
- The door heating element features an adjustable independent control.
- “Out of Limits” temperature protection system is independent of the microprocessor control.

Range	4 °C above ambient temperature to 50 °C
Control increment	0.1 °C
Accuracy	± 0.2 °C
Stability	± 0.1 °C at 37 °C
Uniformity	± 0.6 °C at ambient 20 °C – 25 °C
Uniformity in flask media	± 0.25 °C



If the ambient temperature is close to the programmed value, control settings may need adjusting. Consult Eppendorf Service for instructions.

### 9.4.3 CO<sub>2</sub> control

Solid-state infrared CO<sub>2</sub> sensor is operating independent of humidity. The device has a programmable, fully automatic zeroing function.

Range	0.2–20 %
Control increment	0.1 %
Stability	± 0.2 % at 5 % CO <sub>2</sub>
Uniformity	± 0.1 %
Gas connections	inner diameter of 6.5 mm and outer diameter of 10 mm
Required gas pressure	0.05 MPa (0.5 bar/7.2 psi)

### 9.4.4 Relative humidity

The relative humidity is provided by evaporation of distilled water placed in 2 stainless steel trays at the bottom of the chamber.

Water tray capacity	2 × 250 mL
Humidity control	95 % at 37 °C

The relative humidity attained could vary in the range of 90 % ±5 % depending on ambient humidity level and other factors.

### 9.4.5 Flasks

Applicable flask sizes in combination with number of shelves:

Number of shelves in device	Flask type	Max. size of containable flask
0	Erlenmeyer	up to 4 L
1	Erlenmeyer	up to 1 L
1	Fernbach	up to 2.8 L
2	Erlenmeyer	up to 250 mL

### 9.4.6 Calibration



Maximum operating ambient temperature is 28 °C.  
 Factory calibration of the incubator is carried out at 37 °C, 5 % CO<sub>2</sub> and 90–95 % RH, in an ambient temperature of 20–25 °C with no heat-generating apparatus inside the chamber.

Software calibration adjustments are required to optimize performance, if the incubator is being used outside the operating conditions. Performance specifications are also affected.

Contact Eppendorf Service for advice on calibration adjustments and relevant performance specifications. Be prepared with the model and serial number of your incubator and the complete details of your operating conditions.

Performance values represent the average of instruments checked in the factory under optimum conditions.



## 10 Ordering information

### 10.1 Accessories

Part number	Description
P0628-6502	Stacking kit

Tab. 10-1: Incubation accessories

Part number	Description
P0628-6181	Additional perforated shelf
P0628-5010	Two stage CO <sub>2</sub> regulator
6710070.251	In-line gas filter
P0628-5060	HEPA filter 25 mm
P0628-6150	CO <sub>2</sub> gas analyzer
P0628-7881	Temperature probe 5 mm tip
P0628-7880	Temperature probe 100 mm tip
P0628-5000	CO <sub>2</sub> changeover unit
P0628-6182	Shelf rack (pk of 2)
P0628-6200	S41i Humidity tray

Tab. 10-2: Shaker accessories

Part number	Description
<b>Interchangeable platforms, 612 x 356 mm (24 x 14 in)</b>	
M1334-9920	Universal platform
M1334-9921	125 ml dedicated platform
M1334-9922	250 ml dedicated platform
M1334-9923	500 ml dedicated platform
M1334-9924	1 L dedicated platform
M1334-9925	2 L dedicated platform
M1334-9926	2.8 L dedicated platform
M1334-9927	4 L dedicated platform



When one shelf is installed, the largest flasks that can be contained in this incubator shaker are 1 L Erlenmeyer and 2.8 L Fernbach flasks. Without a shelf, Erlenmeyer flasks up to 4 L can be contained.

Tab. 10-3: Platform accessories

Part number	Description	Dimensions (cm)
M1250-9600	Sticky tape	<b>Length:</b> 1058 cm (416.6 in) <b>Width:</b> 4 cm (1.6 cm)
M1250-9504	Sticky pad adapter kit	46 x 15.25 cm 2 Pieces (18 x 6 in)
M1289-0700	Microplate rack (stack)	H x W x D 13.1 x 9.0 x 18.0 cm (5.16 x 3.54 x 7.09 in)
TTR-221	Microplate rack (1 layer)	45.7 x 13.5 cm (18 x 5.31 in)

Tab. 10-4: Flask clamps

Part number	Clamp size	Dedicated Platform Capacity	Universal Platform Capacity
ACE-10S	10 mL Erlenmeyer	-	-
M1190-9004	25 mL Erlenmeyer	-	-
M1190-9000	50 mL Erlenmeyer	-	-
M1190-9001	125 mL Erlenmeyer	32	20
M1190-9002	250 mL Erlenmeyer	24	16
M1190-9003	500 mL Erlenmeyer	15	12
ACE-1000S	1 L Erlenmeyer	11	10
ACE-2000S	2 L Erlenmeyer	6	4
M1190-9005	2 L Lauber Thompson	-	4
ACFE-2800S	2.8 L Fernbach	3	3
ACE-3000S	3 L Erlenmeyer	-	3
ACE-4000S	4 L Erlenmeyer	3	3
ACSB-500S	500 mL Media Bottle	-	-
ACSB-1000S	1 L Media Bottle	-	-

Tab. 10-5: Test Tube Racks

Rack Size	Part number	Test Tube Diameter	Tubes/Rack	Test Tube Rack Capacity
Small	M1289-0001	8-11 mm	48	6
	M1289-0002	12-15 mm	34	
	M1289-0003	15-18 mm	24	
	M1289-0004	18-21 mm	18	
	M1289-0005	22-26 mm	13	
	M1289-0006	26-30 mm	12	

Rack Size	Part number	Test Tube Diameter	Tubes/Rack	Test Tube Rack Capacity
Medium	M1289-0010	8-11 mm	60	3
	M1289-0020	12-15 mm	44	
	M1289-0030	15-18 mm	31	
	M1289-0040	18-21 mm	23	
	M1289-0050	22-26 mm	16	
	M1289-0060	26-30 mm	16	
Large	M1289-00100	8-11 mm	80	3
	M1289-00200	12-15 mm	60	
	M1289-0300	15-18 mm	42	
	M1289-0400	18-21 mm	30	
	M1289-0500	22-26 mm	22	
	M1289-0600	26-30 mm	20	

Test tube diameter	Tubes (mL)
15 - 18 mm (0.59 - 0.71 in)	15 mL conical tube Eppendorf Tubes 5.0 mL
26 - 30 mm (1.02 - 1.18 in)	50 mL conical tube
8 - 11 mm (0.31 - 0.43 in)	1.5 mL Eppendorf Safe-Lock tube

Tab. 10-6: Connectivity

Part number	Description
1006000.009	VisioNize box with mains/power adapter
1006072.000	Mains/power adapter VisioNize box
1006076.005	VisioNize box adapter
1006073.006	Cable to connect devices with ethernet interface to VisioNize VisioNize box, Ethernet, length 5 m

**Index****A**

Ambient conditions .....	87
ATEX Guideline .....	12

**B**

BMS relay contact alarm .....	27
-------------------------------	----

**C**

Caution, explanation of .....	7
-------------------------------	---

**D**

Danger, explanation of .....	7
Dimensions .....	85
Disposal .....	83

**F**

Flask clamp .....	20
-------------------	----

**H**

Hazard symbols .....	7
High Temperature Disinfection .....	14
HTD .....	14
Humidity trays .....	31

**N**

Notice, explanation of .....	7
------------------------------	---

**O**

Operation speed .....	86
-----------------------	----

**W**

Warning, explanation of .....	7
Weight .....	85

# Declaration of Conformity

The product named below fulfills the requirements of directives and standards listed. In the case of unauthorized modifications to the product or an unintended use this declaration becomes invalid.

**Product name:**

New Brunswick™ S41i

including accessories

**Product type:**

CO<sub>2</sub> Incubator / Shaker

**Relevant directives / standards:**

2014/35/EU: IEC 61010- 1, IEC 61010- 2- 010, IEC 61010- 2- 051,

UL 61010- 1, CSA C22.2 No. 61010- 1

2014/30/EU: EN 55011, EN 61326- 1

2011/65/EU: EN 50581

Date: June 01, 2016



Management Board



Portfolio Management

Your local distributor: [www.eppendorf.com/contact](http://www.eppendorf.com/contact)  
Eppendorf AG · 22331 Hamburg · Germany  
[eppendorf@eppendorf.com](mailto:eppendorf@eppendorf.com)

Eppendorf® and the Eppendorf logo are registered trademarks of Eppendorf AG, Germany.  
U.S. Design Patents are listed on [www.eppendorf.com/ip](http://www.eppendorf.com/ip).  
All rights reserved, incl. graphics and pictures. Copyright 2016 © by Eppendorf AG.

[www.eppendorf.com](http://www.eppendorf.com)

ISO 9001  
Certified

ISO 13485  
Certified

ISO 14001  
Certified





# Evaluate Your Manual

Give us your feedback.

[www.eppendorf.com/manualfeedback](http://www.eppendorf.com/manualfeedback)

**Your local distributor: [www.eppendorf.com/contact](http://www.eppendorf.com/contact)**

Eppendorf AG · Barkhausenweg 1 · 22339 Hamburg · Germany  
[eppendorf@eppendorf.com](mailto:eppendorf@eppendorf.com) · [www.eppendorf.com](http://www.eppendorf.com)