



Miltenyi Biotec

# autoMACS<sup>®</sup> Pro Separator

User manual



Version 5  
Original instructions

**Copyright © 2020 Miltenyi Biotec and/or its affiliates.  
All rights reserved.**

No part of this user manual may be reproduced, stored in a retrieval system, transmitted, published, or distributed in any form or by any means, electronically, mechanically, by photocopying, microfilming, recording, or otherwise, without the prior written consent of Miltenyi Biotec; however, notwithstanding the foregoing, the owners of the autoMACS Pro Separator may make copies solely for purposes of training personnel in the use and servicing of the unit within their business or organization.

Maximal care has been taken by Miltenyi Biotec in the preparation of this user manual. However, Miltenyi Biotec shall not be liable for any technical or editorial errors or omissions contained herein or for incidental or consequential damages in connection with the furnishing, performance, or use of this document. The information in this document is provided "as is" without warranty of any kind, and is subject to change without notice.

autoMACS, MACS, and the Miltenyi Biotec logo are registered trademarks or trademarks of Miltenyi Biotec and/or its affiliates in various countries worldwide. All other trademarks mentioned in this publication are the property of their respective owners and are used for identification purposes only.

Unless otherwise specifically indicated, Miltenyi Biotec products and services are for research use only and not for therapeutic or diagnostic use.



# autoMACS<sup>®</sup> Pro Separator

## User manual

**Version 5 EN**  
**Original instructions**

Miltenyi Biotec B.V. & Co. KG  
Friedrich-Ebert-Straße 68  
51429 Bergisch Gladbach  
Germany

Phone +49-2204-8306-0  
Fax +49-2204-85197  
macsde@miltenyi.com

**[www.miltenyibiotec.com](http://www.miltenyibiotec.com)**



## Read the user manual before using the instrument



Before using the instrument, read chapter Important safety information and all other information contained in this user manual, including all safety and operating instructions. Pay special attention to warnings displayed on the instrument. Failure to read and follow these guidelines could lead to improper or incorrect usage, and result in damage to the instrument. Improper usage could also cause severe personal injury, death, unpredictable results, instrument malfunction, and premature wear of components shortening the lifetime of the instrument. Such actions may void your warranty. Keep this user manual and any other safety and operating instructions provided with the instrument in a safe place that is accessible to all users for reference.

If you are concerned about the safe use of the instrument, please contact your authorized Miltenyi Biotec service provider or call Miltenyi Biotec Technical Support.

# Table of contents

<b>EN</b>	<b>Important safety information</b>	<b>09</b>
<b>DE</b>	<b>Wichtige Sicherheitsinformationen</b>	<b>17</b>
<b>ES</b>	<b>Información importante de seguridad</b>	<b>27</b>
<b>FR</b>	<b>Informations de sécurité importantes</b>	<b>37</b>
<b>IT</b>	<b>Importanti istruzioni di sicurezza</b>	<b>47</b>
<b>1</b>	<b>Introduction</b>	<b>57</b>
1.1	MACS® Technology – the gold standard in cell separation	57
1.2	The autoMACS Pro Separator	58
<b>2</b>	<b>Installation</b>	<b>61</b>
2.1	Components included in delivery	62
2.2	Materials required for operation	62
2.3	autoMACS Pro Separator accessories	64
2.4	Unpacking the autoMACS Pro Separator	64
2.5	Installing and replacing fluid bottles	67
2.6	Installing the MACS MiniSampler Plus, MACS Reagent Rack 4 and tube rack	69
<b>3</b>	<b>Switching on or off</b>	<b>73</b>
3.1	Switching on the instrument	73
3.1.1	When switching on the instrument for the first time	73
3.1.1.1	Installing the pump syringe	75
3.1.1.2	Installing autoMACS Columns	76
3.1.1.3	Set the date and time	78
3.1.1.4	Testing the bar code scanner	78
3.1.1.5	Test the needle calibration	79
3.1.2	Checking fluid levels	79
3.1.3	Priming	80
3.2	Shutting down the instrument	81
3.2.1	Sleep modus	81
3.2.2	Long-term storage	81

<b>4</b>	<b>The autoMACS® Pro user interface</b>	<b>83</b>
4.1	The Status menu	84
4.1.1	Sample status	85
4.1.2	Fluid bottle status	85
4.1.3	Column status	86
4.1.4	Tube rack status	86
4.1.5	MACS MiniSampler Plus status	87
4.2	The Reagent menu	87
4.2.1	Entry of reagents with the 2D code reader	88
4.2.2	Manual entry of reagents	89
4.2.3	Deleting reagents	90
4.2.3.1	Deleting a single reagent from the reagent list	90
4.2.3.2	Deleting the entire reagent list	90
4.3	The Separation menu	90
4.3.1	Sample rack template	91
4.3.2	Sample labeling options	91
4.3.2.1	Assign a labeling option to a single sample	91
4.3.2.2	Assign one labeling option to several samples	91
4.3.2.3	Apply an assigned labeling option to other samples	91
4.3.3	Assigning sample volumes	91
4.3.4	Assigning a cell separation program	92
4.3.5	Assigning a wash program	92
4.3.6	Delete program combinations	92
4.4	The Log list menu	93
4.5	The Option menu	94
4.5.1	Special	94
4.5.2	User settings	95
<b>5</b>	<b>Calibration</b>	<b>97</b>
5.1	Calibrate the needle position	97
5.1.1	Running a test calibration	97
5.1.1.1	Calibrating the needle position	101
5.1.1.2	Calibrate the washing station: Uptake needle (step 1/5)	101
5.1.1.3	Calibrate the washing station: NEG needle (step 2/5)	102
5.1.1.4	Calibration of the z-axis (step 3/5)	103
5.1.1.5	Calibration of the x-axis (step 4/5)	104
5.1.1.6	Test current calibration settings (step 5/5)	104
5.2	Calibrating the uptake volume	106



<b>6</b>	<b>Cell separation</b>	<b>107</b>
6.1	Cell labeling strategies	108
6.1.1	Direct magnetic labeling	108
6.1.2	Indirect magnetic labeling	108
6.2	Cell separation strategies	108
6.2.1	Positive selection	108
6.2.2	Depletion	109
6.2.3	Untouched isolation	109
6.2.4	Sequential sorting	109
6.2.5	Depletion followed by positive selection	109
6.2.6	Two subsequent positive selections	110
6.3	Separation programs	110
6.3.1	Positive selection programs	110
6.3.2	Depletion programs	111
6.4	Wash and maintenance programs	114
6.4.1	Wash programs	114
6.4.2	Maintenance programs	114
6.5	Preparation of single-cell suspensions	115
6.6	Adjusting sample volumes	116
6.7	Selecting the appropriate tube rack	118
6.8	Monitoring the separation process	119
6.8.1	Program status	119
6.8.2	Interrupting cell separation	119
6.8.3	Fluid bottle illumination	120
6.9	Priming the autoMACS Pro Separator	120
6.10	Cell labeling and separation	121
6.10.1	Cell separation using the autolabeling function	122
6.10.2	Cell separation after manual labeling	122
6.10.3	Working with templates	123
6.10.3.1	Saving a reagent template	123
6.10.3.2	Saving a separation template	123
6.10.3.3	Loading a template	123
6.10.3.4	Deleting a template	123
6.11	Shutting down the instrument	124

<b>7</b>	<b>Maintenance</b>	<b>125</b>
7.1	Daily maintenance	125
7.1.1	Instrument priming	125
7.1.1.1	Automatic instrument priming at startup	126
7.1.2	Clean uptake/outlet ports	126
7.2	Periodic maintenance	127
7.2.1	Column exchange	127
7.2.2	Exchange of hydrophobic air filters	128
7.2.3	Clean the pump syringe	128
7.2.4	Cleaning the washing station	131
7.2.5	Instrument disinfection	132
7.3	Corrective maintenance	133
7.3.1	Valve exchange	133
7.3.2	Dilutor valve exchange	136
7.3.3	Exchange of the peristaltic pump head	140
7.3.4	Exchange of tubing system	141
7.3.5	Exchange of fuses	141
<b>8</b>	<b>Quality Control</b>	<b>143</b>
8.1	Cell recovery	143
8.2	Purity of isolated cell population	144
8.3	Viability of the cells	144
<b>9</b>	<b>Troubleshooting</b>	<b>145</b>
9.1	Issues with moving hardware	145
9.2	Hardware issues not indicated by an error screen	146
9.2.1	Column leakage	146
9.2.2	Tubing leakage	146
9.2.3	Pump syringe leakage	147
9.2.4	Pump syringe is filled with air during operation	147
9.2.5	Washing station overflow	147
9.2.6	Outlet port is clogged	148
9.2.7	Contamination of tubing system	148
9.2.8	MACS MiniSampler Plus does not move properly	148
9.2.9	Touchscreen remains dark	148
9.2.10	Disruption of power supply during cell separation	149
9.2.10.1	Rescue procedure A	149
9.2.10.2	Rescue procedure B	149
9.3	Hardware issues indicated by an error screen	150

<b>10</b>	<b>Technical data and specifications</b>	<b>155</b>
10.1	Technical data and specifications	155
10.2	Compliance with FCC rules	158
10.3	EC declaration of conformity (autoMACS® Pro Separator)	159
10.4	EC declaration of conformity (MACS® MiniSampler Plus)	160
<b>11</b>	<b>Technical support</b>	<b>161</b>
<b>12</b>	<b>Limited warranty</b>	<b>163</b>



## Important safety information



### WARNING

The autoMACS® Pro Separator is designed for safe use when installed correctly, operated by trained personnel in accordance with general safety practices and the instructions in this user manual.

## Warnings and precautions

The guidelines in this section explain the potential risks associated with the operation of the instrument and provide important safety information in order to minimize these risks. By carefully following the instructions, you can protect yourself and the equipment from potential hazards and create a safe work environment. If this instrument is used in a manner not specified by the manufacturer, protection may be impaired.

At all times, local working area safety instructions, laboratory policies, and standards regarding laboratory health and safety and prevention of accidents must be adhered to. Contact your local authority governing electrical power supply, building constructions, maintenance, or safety for more information regarding the installation of the equipment.

## Hazard levels

Signal words are used to identify safety and property damage messages. The following signal words are used throughout this user manual.

### WARNING

or **WARNING!** indicates a potentially hazardous situation, which, if not avoided, could result in death or serious injury.

### CAUTION

or **CAUTION!** indicates a potentially hazardous situation, which, if not avoided, could result in minor or moderate injury. It may also be used to alert against unsafe practices.

## Safety symbols

The following symbols are used to highlight conditions that could cause injury to personnel or damage to equipment.



Safety alert. Risk of danger. The documentation needs to be consulted in all cases where this safety symbol is used, in order to find out the nature of the potential hazard and any actions that have to be taken.



Risk of electric shock.



Strong magnetic field.



Persons carrying pacemakers or electronic medical implants must maintain distance.



Risk of crushing and shearing of bodily parts.



Hazardous optical radiation.



Hazardous laser radiation.



Biohazard. Risk of contamination if potentially dangerous biological material is used.



Protective conductor terminal. Symbol is attached on the inside of the instrument. Information for service personnel.



On (Power supply).

Off (Power supply).

## Safety labels

Please notice the hazard points and safety symbols of the autoMACS Pro Separator.

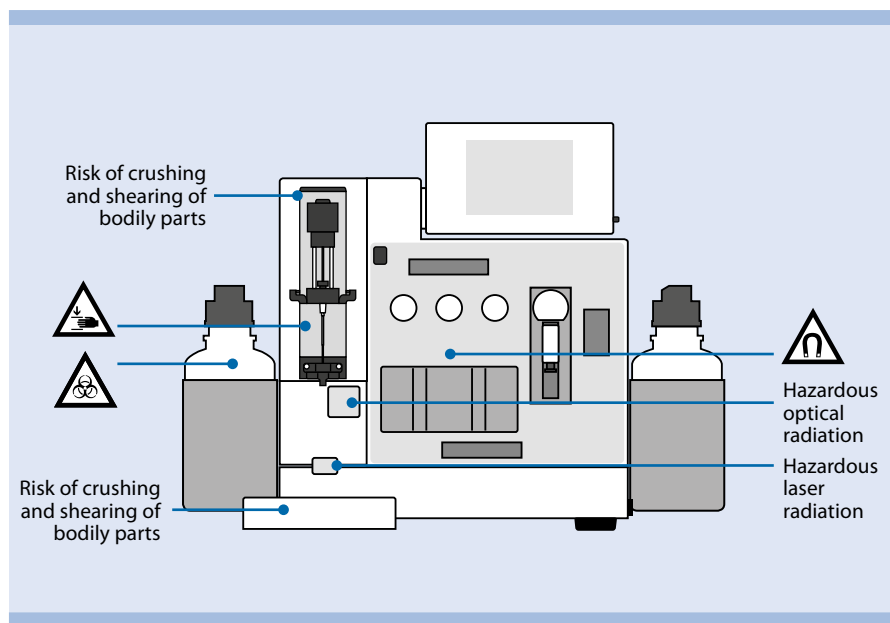

**Figure 1:** Hazard sources and the position of the safety symbols on the front of the autoMACS Pro Separator.

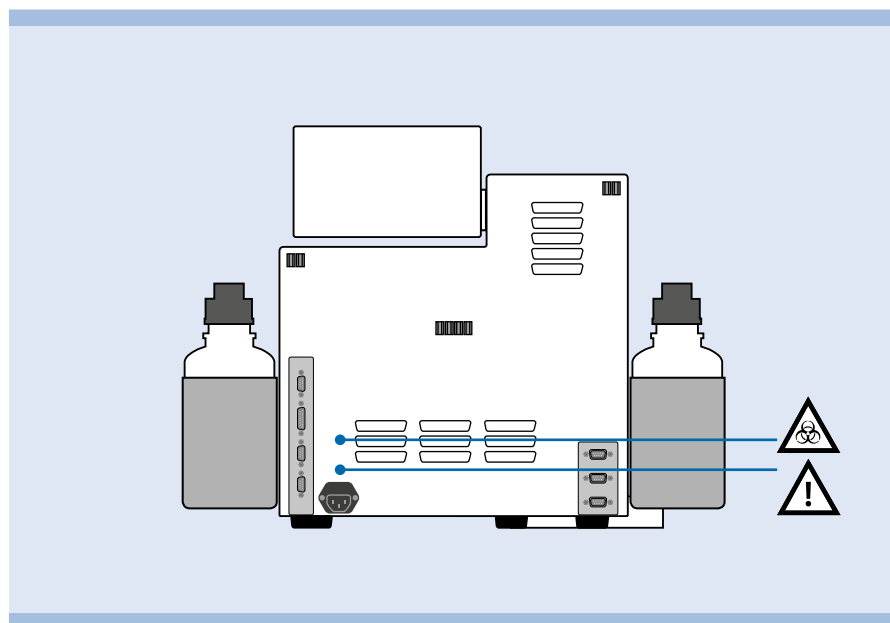

**Figure 2:** Position of the safety symbols on the back of the autoMACS Pro Separator.

The above mentioned safety labels and safety markings must be kept clean and legible. Periodically inspect the safety labels and safety markings and replace them if they are not legible or perceptible from a safe viewing distance. Contact Miltenyi Biotec for replacement labels.

## General safety instructions



If the instrument is not working properly and/or the displayed instructions or messages advise you to contact Technical Support, safe operation of the instrument is no longer possible. Immediately switch off and unplug the instrument from the power outlet, and contact an authorized Miltenyi Biotec service provider or Miltenyi Biotec Technical Support.

## Electricity and fire hazards



**Electrical devices pose the risk of an electric shock. To reduce the risk of an electric shock, do not open any cover other than the front access covers of the autoMACS Pro Separator nor any other accessory hardware supplied by Miltenyi Biotec.** All other covers of the instrument and accessory hardware are to be removed by authorized personnel only. Special care must be taken while handling fluids. Clean up spillages immediately. Do not allow fluids to enter the interior of the instrument. Unplug the power cord before manually cleaning the autoMACS Pro Separator.

**A potential risk exists if an opened, dropped, or damaged autoMACS Pro Separator is used, if liquids are spilled into the instrument, if an object has entered the instrument through the ventilation slots, or if an object has been dropped into the instrument.** If flames or smoke appear immediately switch OFF the autoMACS Pro Separator, unplug the instrument from the electrical outlet, and contact an authorized Miltenyi Biotec service provider or the Miltenyi Biotec Customer Support team. Use of a damaged instrument or an instrument with a damaged power cable is expressly prohibited.

The autoMACS Pro Separator is intended for indoor use only. Do not use the instrument in areas classified as hazardous locations such as oxygen-laden environments. The instrument should not be placed next to radiators, heat registers, stoves, or other pieces of equipment (including amplifiers) that produce heat. Allow sufficient air circulation around the autoMACS Pro Separator—at least 15 cm on all sides—during operation to ensure adequate cooling of the instrument. Prevent direct exposure of the instrument to sunlight. Slots and openings of the instrument are provided for ventilation and should never be blocked or covered, as these ensure reliable operation of the autoMACS Pro Separator and protect the instrument from overheating. Never push a foreign object through an opening into the instrument. Do not use the instrument in a wet or damp location. Avoid high humidity or condensation and protect the machine against water splashes. Unplug the autoMACS Pro Separator from the outlet before cleaning. Do not use liquid or

aerosol cleaning agents; always use a damp cloth.

The instrument is equipped with a three-wire electrical grounding-type plug that has a third pin for grounding. This plug only fits into a grounded power outlet. This is a safety feature. Do not try to insert the plug into a non-grounded power outlet. If you cannot insert the plug into the outlet, contact your local electrician to replace the outlet.

The instrument should only be operated from a power source indicated on the product's electrical ratings label. If you have questions about the type of power source to use, contact your authorized Miltenyi Biotec service provider or local power company. Do not use extension cords or power strips. Do not overload an electrical outlet. The overall system load must not exceed 80% of the branch circuit rating.

Make sure that the main switch as well as the connector for the power cable are easily accessible and located as close to the operator of the instrument as possible. If it is necessary to disconnect the power supply, unplug the cable from the power outlet.

Only peripheral devices that comply to UL 60950 are allowed to be connected to the RS232 connector labeled **COM**. The connector labeled **RS232/AUX** is not in use. In addition, only original autoMACS Pro Separator equipment should be attached to the connectors labeled **External CAN**, **CAN1**, and **CAN2**. The voltage levels on these connectors shall not exceed hazardous voltage levels of 30 V RMS, and 42.4 V peak or 60 Vdc. Only the autoMACS Pro Bottle Sensor Cable should be attached to the **Bottle Sensor** connector. Only a 2D code reader recommended by Miltenyi Biotec should be connected to the **RS232/BCR** connector. External laser devices connected to the connector labeled **RS232/BCR** have to comply with the standard IEC 60825-1. Only use connector cables less than 3m in length.

## Strong magnetic field



The autoMACS Pro Separator is equipped with an extremely powerful magnet. **There is a risk of severe personal injury for persons carrying pacemakers, brain shunts, or electronic medical implants.** Keep any magnetic information carriers (such as credit cards, magnetic tapes, and floppy disks), any electronic equipment (such as hearing aids, pacemakers, measuring and control instruments, computers, and watches), and magnetizable tools and objects at a distance of at least 20 cm from the magnet cover. These items may be affected or damaged by the magnetic field.

EN

DE

ES

FR

IT



## Mechanical hazards



Do not open the front access covers while the instrument is in operation. Do not obstruct the movement of the automated arm and accessory hardware during operation. **Keep fingers etc. away from all moving parts of the autoMACS Pro Separator and accessory hardware, to avoid crushing or shearing injuries, or damage to the instrument.** Do not touch fluid pumps or adjust the tubing, while the instrument is in operation. Always switch off the instrument before adjusting any part of the fluidic system. Always stop or abort a procedure before handling accessory hardware, e.g., MACS MiniSampler Plus, or loading/removing tubes from the tube rack placed on the sampler. **Do not circumvent any safety measures or devices.**

## Optical radiation hazards



The instrument is equipped with four vertical cavity surface emitting lasers (VCSELs) for automated rack detection (Class 1M). The radiation is not visible. Do not view directly with optical instruments (e.g. lenses, magnifying glasses, and microscopes). Viewing the VCSEL port within 100 mm distance with optical instruments could be hazardous to the eye.

The instrument is also equipped with a 2D Code Reader which uses a visible semiconductor laser as a target pointer for adjusting the reading position and powerful light emitting diodes (LEDs) for illuminating the reading area and the fluid bottles as well as the waste bottle. Do not remove the bottle holders.

According to the international standard IEC 62471 this lamp system has an exposure hazard value (EHV) of 0.91 and is in excess of the Exempt Risk Group. The hazard distance (HD) for the Exempt Risk Group is 61 cm. The hazard distance for Risk Group 1 is 20 cm.

**Do not look directly at laser or LED radiation or reflected laser or LED radiation from a mirrored surface.** Otherwise, eye injury may result. Do not intentionally direct the laser beam at others. Do not disassemble, modify or remove the installed laser or LED radiation sources or their mounting brackets. The laser or LED radiation sources do not automatically stop emitting when disassembled. Radiation of disassembled units may lead to eye injuries. Be careful of the path of the laser beam or reflection from a mirrored surface. Take care during installation of the autoMACS Pro Separator that the path of the laser beam is not at the same height as that of the human eye during operation.

Do not allow water, oil, dust, or other foreign substances to stick to 2D Code Reader aperture window. This may cause read errors. Be sure to stop the laser emission before cleaning the scanner. Otherwise, exposure to the laser may cause eye injury. Use a soft, dry cloth to wipe any substances from the scanner. Do not use alcohol or other cleaning substance.

The autoMACS Pro Separator is classified as a Class 1M laser product per standard IEC 60825-1.

Use of controls or adjustments or performance of procedures other than those specified herein may result in hazardous radiation exposure.

## Chemical and biological hazards



If biohazardous material has been used, the operator shall choose and wear personal safety equipment in accordance with warnings and precautions for the used substances. Wear protective gloves, protective clothing, and safety glasses to prevent contact with skin and eyes. Also protect mouth and nose as aerosols might leak from the system. Defective or inadequate safety equipment might endanger the operator. The autoMACS Pro Separator shall be operated in a safety hood if hazardous or unknown materials are processed. If hazardous material has been used or spilled, care must be taken to thoroughly decontaminate the system.

Always inspect the fluidic system (complete tubing set, bottles and their closures, valves, columns, diluter, and needles) before switching on the instrument. **If leakage has been detected, replace all damaged parts before switching ON the instrument.** If damaged parts cannot be replaced, unplug and do not use the instrument. Failure of parts containing biohazardous material or liquids that have been in contact with such material could cause a hazard.

Columns, tubes, and any other consumables that were in contact with biohazardous samples shall be autoclaved prior to disposal. Liquid waste shall be autoclaved or decontaminated using a disinfectant that is appropriate for the specific pathogen, e.g. 10% bleach, isopropyl alcohol, or 70% ethanol. Waste disposal must be in accordance with any local regulations.

70% ethanol is used in Sleep and Store programs. The solvent is flammable. Therefore, keep the instrument away from fire.

## Servicing, transport and disposal



Unless otherwise specifically noted in this user manual or other Miltenyi Biotec documentation, **do not service the autoMACS Pro Separator yourself.** Servicing and repair must be performed by qualified service personnel. Improper or incorrect servicing or repair of your autoMACS Pro Separator can cause hazards to users, lead to unpredictable results, instrument malfunction or damage, premature wear and reduced life time of the instrument, and may void your warranty.

When replacement or spare parts are required, make sure that the service provider uses only genuine Miltenyi Biotec parts or third-party parts specified and recommended by Miltenyi Biotec. Using unauthorized replacement or spare parts can cause malfunction of the instrument and impair cell separation results.

Miltenyi Biotec does not honor any warranty or accept any responsibility for instrument failure or damages resulting from the use of inappropriate replacement or spare parts. After completing any service or repair work, have your authorized Miltenyi Biotec service provider perform all safety checks required by the repair procedure to ensure that the instrument is in proper operational condition.

**Only use options and upgrades recommended by Miltenyi Biotec.** Inquire with your local Miltenyi Biotec representative about Miltenyi Biotec's extensive instrument service and support arrangements, or refer to **[www.miltenyibiotec.com/support](http://www.miltenyibiotec.com/support)**.

The autoMACS Pro Separator should be transported with care in packaging specified by Miltenyi Biotec. Internal damage can occur, if it is subjected to excessive vibration or if it is dropped. If the instrument needs to be shipped back to the manufacturer for service, decontaminate the instrument from any hazardous material prior to shipment. If you have questions regarding proper decontamination or shipment, please contact Technical Support for assistance.



#### **Waste of Electrical and Electronic Equipment (WEEE) customer information**

Please dispose of your end-of-life Miltenyi Biotec products in accordance with the applicable WEEE and hazardous waste disposal legislation, which may differ by country or region.

Electrical and electronic equipment may contain hazardous substances which may have a serious detrimental effect on the environment and/or human health. That is why all equipment must be specifically collected and treated by designated waste facility centres and by qualified WEEE compliance schemes. By ensuring that you dispose of your unwanted electrical and electronic equipment according to the applicable WEEE and hazardous waste disposal legislation, you are helping to preserve our natural resources and protect human health.

Miltenyi Biotec is committed to protecting the environment. Miltenyi Biotec offers product end-of-life return programs in many countries, and partners with licensed WEEE compliance schemes throughout the world. Miltenyi Biotec lets you recycle your end-of-life Miltenyi Biotec equipment free of charge. The terms and availability of this offer vary by geography because of differences in regulatory requirements. Please note that, depending on the type and use of your equipment, additional requirements may apply.

For more information, or if you wish to dispose of your end-of-life Miltenyi Biotec equipment, please contact your local Miltenyi Biotec representative or Miltenyi Biotec Technical Support.



# Wichtige Sicherheitsinformationen



**WARNING**

Der autoMACS® Pro Separator ist für einen sicheren Betrieb ausgelegt, wenn das Gerät richtig installiert, von geschultem Personal bedient und entsprechend der Sicherheitsrichtlinien und Anweisungen in diesem Benutzerhandbuch eingesetzt wird.

## Warn- und Sicherheitshinweise

Dieses Kapitel erklärt die im Umgang mit dem Gerät möglichen Gefahren und gibt wichtige Sicherheitshinweise zur Vermeidung dieser Gefahren. Halten Sie sich genau an diese Hinweise, um sich selbst und das Gerät vor möglichen Gefahren zu schützen und ein sicheres Arbeitsumfeld zu garantieren. Bei Verwendung des Geräts unter Missachtung der Herstelleranweisungen ist die Sicherheit nicht gewährleistet.

Örtliche Arbeitsschutzbestimmungen, Laborrichtlinien, Sicherheitsnormen und Unfallverhütungsvorschriften müssen auf jeden Fall beachtet werden. Wenden Sie sich an die örtlichen Behörden und Ihren Stromversorger für weitere Informationen zur Stromversorgung, Gebäudeinstallationen, Wartung und Sicherheit für die Installation dieses Gerätes.

## Gefahrenstufen

Gefahrensymbole sollen auf Sicherheits- und Sachschadenshinweise aufmerksam machen. Folgende Gefahrensymbole werden in diesem Benutzerhandbuch verwendet.

**WARNING**

oder **WARNING!** bezeichnet eine Gefahrensituation, die, falls sie nicht vermieden wird, zum Tode oder schwerwiegenden Verletzungen führen kann.

**CAUTION**

oder **CAUTION!** bezeichnet eine Gefahrensituation, die, falls sie nicht vermieden wird, zu leichteren oder mittelschweren Verletzungen führen kann. Es kann auch verwendet werden, um vor unsicherem Gebrauch zu warnen.

EN

DE

ES

FR

IT

## Gefahrensymbole

Die folgenden Symbole werden benutzt um Gefahrensituationen anzuzeigen, welche zu Sach- und Personenschaden führen können.



Warnzeichen. Gefahrenrisiko. Dieses Benutzerhandbuch muss immer konsultiert werden, wenn dieses Warnzeichen benutzt wird, um mehr über die möglichen Gefahren und entsprechende Handlungsanweisungen zu erfahren.



Gefahr eines Stromschlags.



Starkes Magnetfeld.



Personen mit Herzschrittmacher oder elektronischen medizinischen Implantaten müssen Abstand halten.



Quetsch- und Schergefahr.



Gefahr durch optische Strahlung.



Gefahr durch Laserstrahlung.



Biologische Gefährdung. Risiko der Kontamination, wenn mit möglicherweise gefährlichen biologischen Substanzen gearbeitet wird.



Schutzleiteranschluss. Dieses Symbol ist innerhalb des Geräts angebracht und stellt einen Hinweis für das Servicepersonal dar.



An (Stromversorgung).

Aus (Stromversorgung).

# Sicherheitskennzeichnungen

Bitte achten Sie auf die Gefahrenpunkte und die Gefahrensymbole des autoMACS Pro Separator Instruments.

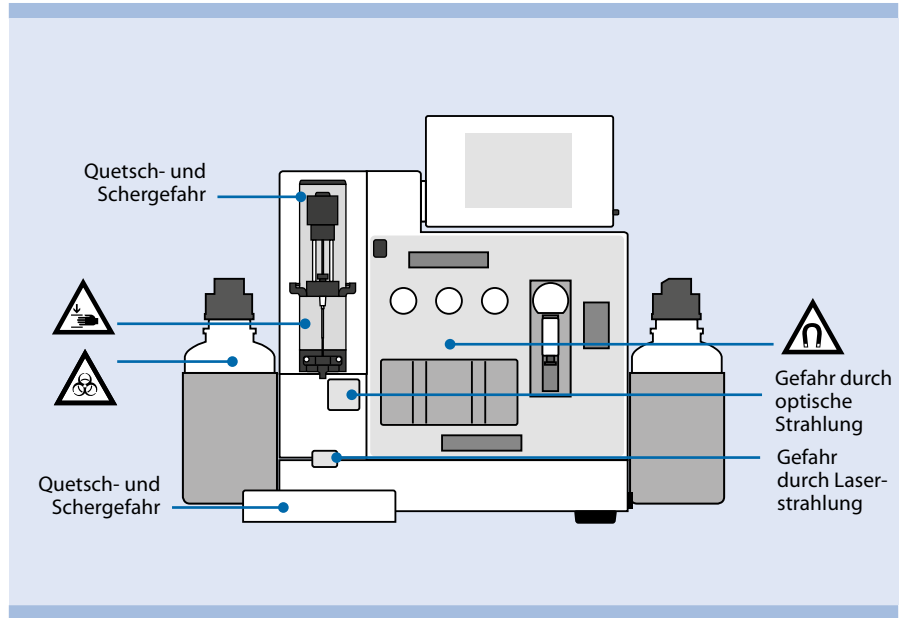

**Figure 3:** Gefahrenquellen und Gefahrensymbole auf der Vorderseite des autoMACS Pro Separators.

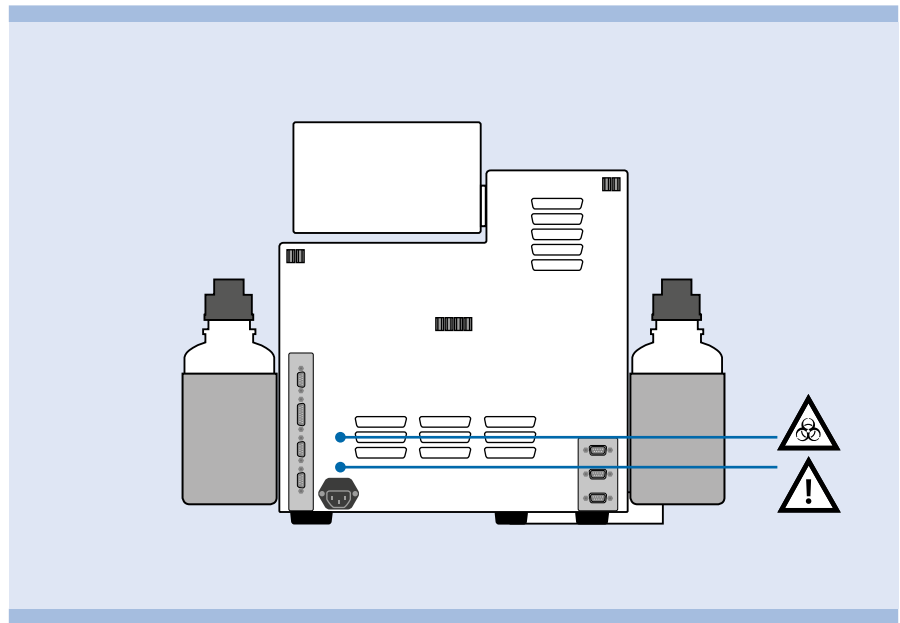

**Figure 4:** Gefahrensymbole auf der Rückseite des autoMACS Pro Separators.

Alle angegebenen Sicherheitsaufkleber und Markierungen müssen sauber und lesbar bleiben. Überprüfen Sie die Aufkleber regelmäßig und ersetzen Sie diese, sollten sie aus sicherem Abstand nicht mehr lesbar sein. Kontaktieren Sie Miltenyi Biotec, um Ersatzaufkleber zu erhalten.

## Allgemeine Sicherheitshinweise



Falls Ihr Gerät nicht einwandfrei funktioniert und/oder Anzeigen auf dem Display Sie dazu auffordern den technischen Kundendienst zu kontaktieren, ist die Betriebssicherheit des Gerätes nicht länger gewährleistet. Schalten Sie das Gerät sofort aus, ziehen Sie den Netzstecker und kontaktieren Sie einen autorisierten Miltenyi Biotec Servicedienstleister oder den Miltenyi Biotec Technical Support.

## Elektrische Gefährdung und Brandgefahr



**Der Umgang mit elektrischen Geräten birgt das Risiko eines Stromschlags. Um diese Gefahr zu minimieren, öffnen Sie weder das Gehäuse des autoMACS Pro Separators noch anderes Zubehör.** Alle Abdeckungen sowie das Geräte-Zubehör dürfen nur von geschultem Personal entfernt werden. Besondere Vorsicht ist geboten beim Umgang mit Flüssigkeiten. Beseitigen Sie ausgetretene oder verschüttete Flüssigkeit sofort. Es darf unter keinen Umständen Flüssigkeit in das Innere des Gerätes eindringen. Ziehen Sie den Netzstecker vor manueller Reinigung des autoMACS Pro Separators.

**Eine potentielle Gefahrenquelle liegt auch im Betrieb eines geöffneten, zu Boden gefallen oder beschädigten Gerätes. Ebenfalls sollte unbedingt vermieden werden, dass Flüssigkeit in das Gerät gelangt, Fremdkörper durch die Belüftungsöffnungen eindringen oder von außen in das Instrument hinein gelangen.** Bei Auftreten von Flammen oder Rauchentwicklung schalten Sie das Gerät sofort aus, trennen es von der Stromzufuhr und kontaktieren einen autorisierten Miltenyi Biotec Service Provider oder das Miltenyi Biotec Customer-Support-Team. Der Betrieb eines beschädigten Gerätes oder eines Gerätes mit schadhaftem Stromkabel ist ausdrücklich verboten.

Der autoMACS Pro Separator ist ausschließlich ausgelegt für den Betrieb in Innenräumen. Bitte benutzen Sie das Gerät nicht in ausgewiesenen Gefahrenzonen wie etwa sauerstoffangereicherten Arbeitsumgebungen. Das Instrument sollte nicht in der Nähe von Radiatoren, Heißlüfter, Öfen oder anderen, Wärme erzeugenden Geräten stehen (Verstärker eingeschlossen). Ermöglichen Sie im Betrieb eine ausreichende Luftzirkulation im Abstand von mindestens 15 cm in allen Richtungen um den autoMACS Pro Separator, um eine ausreichende Kühlung zu gewährleisten. Vermeiden Sie, das Gerät direkter Sonneneinstrahlung auszusetzen. Öffnungen und Schlitz am Gerät sind zur Belüftung gedacht und sollten niemals bedeckt oder blockiert werden, da sie das Gerät vor Überhitzung schützen und sicheren Betrieb ermöglichen. Führen Sie niemals Fremdkörper durch Öffnungen in das Gerät ein.

Setzen Sie das Instrument niemals in einer feuchten oder nasskalten Umgebung ein. Setzen Sie das Gerät nie hoher Feuchtigkeit oder Kondensation aus und schützen Sie es gegen Spritzwasser. Ziehen Sie den Netzstecker vor Reinigung des Gerätes. Verwenden Sie keine Flüssig- oder Sprühreinigungsmittel, sondern nur ein feuchtes Tuch.

Das Gerät ist ausgestattet mit einem Schutzkontaktstecker und einer dreiadrigen Anschlussleitung. Führen Sie den Stecker nicht in eine Steckdose ohne Schutzkontakt ein. Wenn Ihre Steckdose keinen Schutzkontakt aufweist, bitten Sie einen ortsansässigen Elektriker, diese zu ersetzen.

Das Gerät sollte nur von einer Stromquelle aus betrieben werden, die den elektrischen Angaben auf dem Typschild entsprechen. Sollten Sie Fragen zur Art der Stromversorgung haben, wenden Sie sich an einen autorisierten Miltenyi Biotec Service Provider oder Ihren lokalen Stromversorger. Benutzen Sie keine Verlängerungskabel oder Steckdosenleiste. Überladen Sie eine Steckdose nicht. Die Gesamtlast darf 80 % der Zweigstromkreis-bemessung nicht überschreiten.

Der Hauptstromschalter ebenso wie der Netzstecker für das Stromkabel sollten leicht zugänglich sein und sich in möglichst unmittelbarer Nähe zum Bediener des Gerätes befinden. Sollte es erforderlich sein, die Stromzufuhr zu unterbrechen, ziehen Sie den Netzstecker.

An die mit **COM** beschriftete RS-232-Buchse dürfen nur Peripheriegeräte angeschlossen werden, die UL 60950 erfüllen. Die mit **RS232/AUX** beschriftete Buchse ist nicht belegt. An die mit **External CAN, CAN1** und **CAN2** beschrifteten Buchsen dürfen nur Original autoMACS Pro Geräte angeschlossen werden. Die Spannung an diesen Buchsen darf die gefährlichen Werte von 30 Veff und 42,4 V Spitze bzw. 60 V DC nicht übersteigen. An die mit **Bottle Sensor** beschriftete Buchse darf nur das autoMACS Pro Flaschensensorkabel angeschlossen werden. An die mit **RS232/BCR** beschriftete Buchse darf nur ein von Miltenyi Biotec empfohlener 2D-Barcodeleser angeschlossen werden. Externe Lasergeräte, die an die mit **RS232/BCR** beschriftete Buchse angeschlossen werden, müssen IEC 60825-1 erfüllen. Es dürfen nur Anschlusskabel mit einer Länge von max. 3 Metern verwendet werden.

## Starkes Magnetfeld



Der autoMACS Pro Separator enthält einen extrem starken Magneten. **Es besteht die Gefahr von schweren Verletzungen für Personen mit Herzschrittmacher, Cerebralschunts oder elektronischen medizinischen Implantaten.** Halten Sie mit magnetischen Datenträgern (Kreditkarten, Magnetbänder, Speichermedien und dergleichen) und elektronischen Geräten (wie Hörgeräte, Herzschrittmacher, Mess- und Steuergeräte, PCs, Uhren) mindestens 20 cm Abstand zur Magnetabdeckung, da diese durch das Magnetfeld gestört und geschädigt werden können.



## Mechanische Gefahr



Frontabdeckungen nicht öffnen, wenn das Gerät läuft. Bewegung des Automatikarms und der zugehörigen Komponenten im Betrieb nicht behindern. **Finger usw. von allen bewegten Teilen des autoMACS Pro Separator und zugehörigen Komponenten fernhalten, es besteht sonst Gefahr von Quetsch- und Scherverletzungen und Schäden am Gerät.** Flüssigkeitspumpen nicht berühren und Leitungen nicht verändern, wenn das Gerät läuft. Gerät immer ausschalten, bevor Arbeiten am Flüssigkeitssystem vorgenommen werden. Laufenden Vorgang immer anhalten oder abbrechen, bevor Arbeiten an Zusatzgeräten wie dem MACS MiniSampler Plus ausgeführt oder Reagenzgläser aus dem Reagenzglasgestell im Sampler entnommen oder dort eingesetzt werden. **Sicherheitsmaßnahmen und -vorrichtungen niemals umgehen oder manipulieren.**

## Gefahr durch optische Strahlung



Das Gerät ist zur automatischen Reagenzglasgestell-erkennung (Klasse 1M) mit vier oberflächenemittierenden Lasern mit vertikalem Resonator (VSCLs) ausgestattet. Die Strahlung ist nicht sichtbar. Schauen Sie nicht direkt mit optischen Instrumenten (z. B. Objektiven, Vergrößerungsgläsern und Mikroskopen) hinein. Das Hineinschauen mit optischen Instrumenten in die VSCL-Öffnung innerhalb eines Abstandes von 100 mm kann Ihre Augen schädigen.

Das Gerät ist auch mit einem 2D-Code-Leser ausgestattet, der einen sichtbaren Halbleiterlaser als Target-Pointer (Zeiger) zur Einstellung der Leseposition verwendet, sowie leistungsstarken Leuchtdioden (LEDs) zur Beleuchtung des Lesefeldes und der Flüssigkeitsbehälter und des Abfallbehälters. Entfernen Sie nicht die Flaschenkörbe.

Gemäß der internationalen Norm IEC 62471 hat dieses Lampensystem einen Gefahrenwert der Exposition (EHV) von 0,91 und ist außerhalb der Freien Gruppe. Der Gefährdungsabstand (HD) für die Freie Gruppe beträgt 61 cm. Der Gefährdungsabstand für die Risikogruppe 1 beträgt 20 cm.

**Schauen Sie weder direkt in die Laser- oder LED-Strahlung noch in eine durch eine Spiegelfläche reflektierte Laser- oder LED-Strahlung.** Dies kann sonst zu Augenverletzungen führen. Richten Sie den Laserstrahl nicht absichtlich auf andere Personen. Demontieren, wechseln oder entfernen Sie nicht eingebaute Laser- oder LED-Strahlungsquellen oder deren Halterung. Die Laser- oder LED-Strahlungsquellen hören bei Demontage nicht automatisch auf, Strahlung zu emittieren. Strahlung von demontierten Geräten kann zu Augenverletzungen führen. Achten Sie auf den optischen Weg des Laserstrahls oder der Reflektion durch eine Spiegelfläche. Achten Sie bei der Einrichtung des autoMACS Pro Separator darauf, dass sich der optische Weg des Laserstrahls beim Betrieb nicht auf gleicher Höhe mit dem menschlichen Auge befindet.

Vermeiden Sie, dass Wasser, Öl, Staub oder andere Fremdkörper dem Öffnungsfenster des 2D-Code-Lesers anhaften. Dies kann zu Lesefehlern führen. Stellen Sie vor der Reinigung des Scanners sicher, dass keine Laserstrahlen mehr emittiert werden. Der Umgang mit dem Laser kann sonst zu Augenverletzungen führen. Verwenden Sie zum Abwischen von Substanzen auf dem Scanner ein weiches, trockenes Tuch. Verwenden Sie keinen Alkohol oder andere Reinigungssubstanzen.

Der autoMACS Pro Separator ist nach Norm IEC 60825-1 als Klasse 1M-Laserprodukt eingestuft.

Die Verwendung von anderen als hierin genannten Bedienungselementen sowie die Anpassung oder Durchführung von anderen als hier genannten Verfahren kann gefährliche Strahlung freisetzen.

## Chemische und biologische Gefahren



Wird oder wurde mit biologischen Gefahrenstoffen gearbeitet, muss der Bediener des Gerätes entsprechend den für die verwendeten Substanzen geltenden Warnhinweisen und Schutzbestimmungen eine persönliche Schutzausrüstung tragen. Tragen Sie Schutzhandschuhe, Schutzkleidung, und Schutzbrille, um Berührung der Gefahrenstoffe mit Haut und Augen zu vermeiden. Schützen Sie auch Ihren Mund und Nase, da Aerosole aus undichten Stellen des Systems austreten könnten. Mangelhafte oder unzureichende Schutzausrüstung kann den Bediener des Instrumentes gefährden. Werden biologische Gefahrenstoffe oder unbekannte Substanzen eingesetzt, sollten Sie mit dem autoMACS Pro Separator in einer Sterilbank arbeiten. Falls Gefahrstoffe verwendet wurden oder ausgetreten sind, achten Sie auf eine sorgfältige Dekontaminierung des Gerätes.

Vor Inbetriebnahme des Gerätes überprüfen Sie das fluidische System (das Schlauchsystem, Flaschen und deren Verschlüsse, Ventile, Säulen, Verdünnerventil und Nadeln) und ersetzen Sie beim Feststellen einer undichten Stelle alle beschädigten Teile. Können beschädigte Teile nicht ersetzt werden, ziehen Sie den Netzstecker und benutzen Sie das Gerät nicht. Beschädigte Teile, die mit biologischen Gefahrenstoffen in Kontakt waren, sind potentiell gefährlich.

Säulen, Auffanggefäße und alle weiteren Verbrauchsmaterialien, die in Kontakt mit biologischen Gefahrenstoffen gelangt sind, sollten vor Entsorgung autoklaviert werden. Flüssigabfall sollte autoklaviert oder unter Verwendung eines für das jeweilige spezifische Pathogen geeigneten Desinfektionsmittels dekontaminiert werden, z.B. 10% Bleichmittel, Isopropylalkohol oder 70% Ethanol. Die Entsorgung der Verbrauchsmaterialien muss gemäß lokal geltender Bestimmungen erfolgen.

EN

DE

ES

FR

IT

## Wartung, Transport und Geräteentsorgung



**Versuchen Sie nicht, den autoMACS Pro Separator selbst zu warten oder zu reparieren** – es sei denn, es ist in diesem Benutzerhandbuch oder anderen technischen Unterlagen der Miltenyi Biotec B.V. & Co. KG ausdrücklich vermerkt. Wartung und Reparaturen müssen durch geschulte Fachkräfte ausgeführt werden. Falsche oder unsachgemäße Wartung oder Reparatur an Ihrem Gerät kann zur Gefährdung des Anwenders, unvorhersehbaren Resultaten, Fehlfunktionen, Geräteschäden, vorzeitigem Verschleiß und verringerter Lebensdauer führen und kann den Verlust Ihrer Garantieansprüche zur Folge haben.

Wenn Ersatzteile benötigt werden, stellen Sie sicher, dass Ihr Service Provider nur Originalteile der Miltenyi Biotec B.V. & Co. KG oder Teile von Drittanbietern verwendet, die von der Miltenyi Biotec B.V. & Co. KG spezifiziert und empfohlen werden. Die Verwendung unautorisierter Ersatzteile kann Fehlfunktionen des Gerätes verursachen und die Ergebnisse von Zellseparationen beeinträchtigen. Die Miltenyi Biotec B.V. & Co. KG akzeptiert keinerlei Garantieansprüche und haftet nicht für Fehlfunktionen oder Schäden am Gerät, die auf Verwendung ungeeigneter Verschleiß- oder Ersatzteile zurückzuführen sind. Nach jedweder erfolgter Wartungs- oder Reparaturleistung lassen Sie Ihren autorisierten Miltenyi Biotec Service Provider alle notwendigen Sicherheitsprüfungen durchführen, um sicherzustellen, dass das Gerät sich in vorschriftsmäßigem Zustand befindet.

**Nutzen Sie nur von Miltenyi Biotec empfohlenes Zusatzgerät und Upgrades zu Ihrem Gerät.** Fragen Sie Ihren örtlichen Miltenyi Biotec Vertriebsmitarbeiter nach Miltenyi Biotecs weit reichenden Vereinbarungen zum Geräteservice und Technical Support oder besuchen unsere Website: [www.miltenyibiotec.com/support](http://www.miltenyibiotec.com/support).

Der autoMACS Pro Separator sollte vorsichtig gehandhabt in der von Miltenyi Biotec bereit gestellten Verpackung transportiert werden. Im Gerät können innere Schäden auftreten, falls es großer Erschütterung ausgesetzt oder fallengelassen wird. Sollte wegen Reparatur- oder Wartungsleistungen ein Rücktransport zum Hersteller notwendig werden, dekontaminieren Sie das Gerät vor Versand von jeglichen biologischen Gefahrenstoffen. Wenn Sie Fragen zur vorschriftsmäßigen Dekontaminierung oder zum Versand des Gerätes haben, wenden Sie sich bitte direkt an unseren Technical Support.



**Kundeninformation zur Entsorgung von Elektro- und Elektronik-Altgeräten (Waste of Electrical and Electronic Equipment, WEEE)**

Bitte entsorgen Sie Ihre Altgeräte von Miltenyi Biotec unter Einhaltung der jeweils geltenden Vorschriften für die Erfassung und Behandlung von Elektro- und Elektronik-Altgeräten und die Entsorgung von Gefahrstoffen. Diese können von Land zu Land sowie regional variieren.

Elektrische und elektronische Geräte können Gefahrstoffe enthalten, welche die Umwelt erheblich belasten und/oder die Gesundheit gefährden. Deshalb müssen Altgeräte speziell gesammelt und durch ausgewiesene Entsorgungsbetriebe im

Rahmen der hierfür vorgesehenen Entsorgungssysteme fachgerecht behandelt werden. Indem Sie sicherstellen, dass Ihr Altgerät gemäß den geltenden Vorschriften zur Behandlung von Elektro- und Elektronik-Altgeräten sowie von Gefahrstoffen entsorgt wird, tragen Sie dazu bei, unsere natürlichen Ressourcen zu schonen und die menschliche Gesundheit zu schützen.

Miltenyi Biotec setzt sich für den Schutz der Umwelt ein. Miltenyi Biotec bietet in zahlreichen Ländern eigene Rücknahmeprogramme für Altgeräte an und arbeitet weltweit mit lizenzierten Partnern zusammen, die an bestehende Recycling- und Entsorgungssysteme angeschlossen sind. Miltenyi Biotec ermöglicht Ihnen ein kostenloses Recycling Ihres Altgerätes. Die Bedingungen und die Verfügbarkeit dieses Angebots unterscheiden sich geographisch aufgrund unterschiedlicher regulatorischer Anforderungen. Bitte beachten Sie, dass je nach Art und Nutzung Ihres Gerätes zusätzliche Anforderungen gelten können.

Für weitere Informationen oder wenn Sie Ihr Miltenyi Biotec-Altgerät entsorgen möchten, wenden Sie sich bitte an Ihren lokalen Miltenyi Biotec-Vertreter oder den Miltenyi Biotec Technical Support.

EN

DE

ES

FR

IT



# ES

## Información importante de seguridad



El separador autoMACS Pro está diseñado para un uso seguro si se instala correctamente, y se maneja por personal cualificado de acuerdo con las prácticas generales de seguridad y las instrucciones de este manual de usuario.

### Advertencias y precauciones

Las directrices del presente capítulo explican los potenciales riesgos asociados al manejo del instrumento y suministran información importante a fin de reducir dichos riesgos al mínimo. Si sigue cuidadosamente las instrucciones, se protegerá a sí mismo y al equipo de posibles peligros y creará un ambiente de trabajo seguro. Si este instrumento es manejado de un modo no previsto por su fabricante la seguridad se verá mermada.

En todo momento se debe observar la normativa nacional de seguridad en el trabajo, las normas del laboratorio, y los estándares de salud y seguridad en el laboratorio y de prevención de accidentes. Póngase en contacto con la autoridad local competente para el suministro de electricidad, construcción de edificios, mantenimiento o seguridad para obtener más información sobre la instalación del equipo.

### Niveles de riesgo

Se usan señales para identificar mensajes de seguridad y de daño de la propiedad. Las siguientes señales se usan a través de este manual de usuario.

#### **WARNING**

o **WARNING!** indica una situación potencialmente peligrosa, la cual, si no se evita, puede resultar en muerte o daños graves.

#### **CAUTION**

o **CAUTION!** indica una situación potencialmente peligrosa, la cual, si no se evita, puede resultar en un daño menor o moderado. También puede ser usado para alertar contra prácticas peligrosas.

EN

DE

ES

FR

IT

## Simbolos de seguridad

Los siguientes símbolos se usan para destacar condiciones que podrían causar daños al personal o daños al equipo.



Alerta de seguridad. Riesgo de peligro. Es necesario consultar la documentación del equipo siempre que este símbolo de seguridad aparezca, para de esta manera poder averiguar la naturaleza del peligro potencial existente y las acciones necesarias a realizar.



Riesgo de shock eléctrico.



Campo magnético intenso.



Personas con marcapasos o implantes médicos electrónicos deben mantenerse alejadas.



Riesgo de que se aplaste o corte alguna parte del cuerpo.



Radiación óptica peligrosa.



Radiación láser peligrosa.



Riesgo biológico. Riesgo de contaminación si se usa material biológico potencialmente peligroso.



Bloques de conexión para conductores de protección. El símbolo está pegado en el interior del instrumento. Esta información es para el personal de servicio.



Encendido (Fuente de energía).

Apagado (Fuente de energía).

## Etiqueta de seguridad

Por favor tenga en cuenta los puntos de peligro y los símbolos de seguridad del autoMACS Pro Separator Instrument.

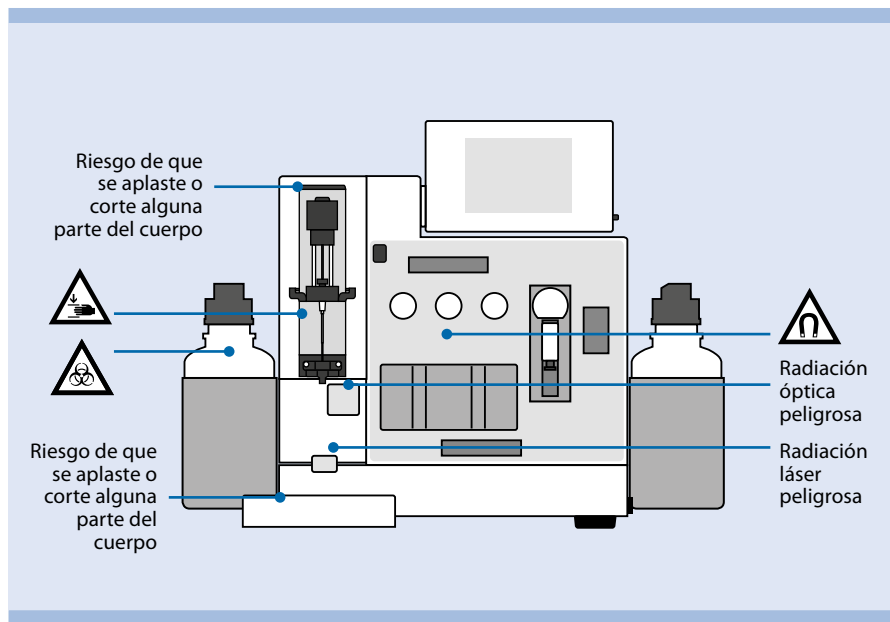

**Figure 5:** Puntos de peligro y localización de símbolos de seguridad que puede encontrar en la parte delantera del autoMACS Pro Separator.

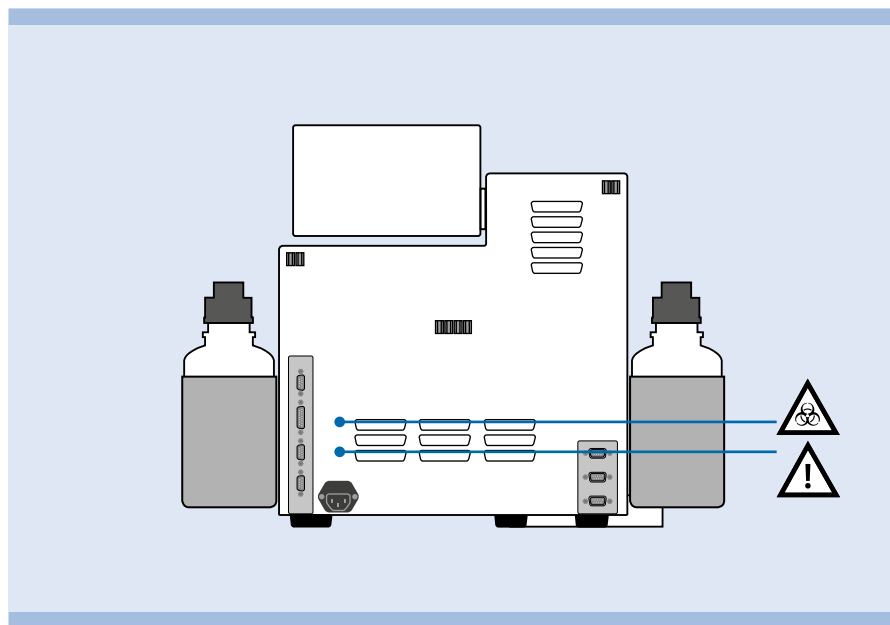

**Figure 6:** Localización de los símbolos de seguridad en la parte trasera del autoMACS Pro Separator Instrument.



Las etiquetas de seguridad arriba mencionadas y las marcas de seguridad deberán mantenerse limpias y legibles. Inspeccionar periódicamente las etiquetas y marcas de seguridad y reemplazarlas en caso de que estas no sean legibles o perceptibles a una distancia visual segura. Contacte con Miltenyi Biotec para reemplazo de etiquetas.

## Instrucciones generales de seguridad



Si el instrumento no funciona correctamente y/o las instrucciones o mensajes mostrados le aconsejan contactar con el servicio técnico, no es posible utilizar el instrumento de una manera segura. Apague y desenchufe inmediatamente el instrumento de la toma de corriente, y contacte un proveedor de servicios autorizado de Miltenyi Biotec o un servicio técnico autorizado.

## Incendios y riesgos eléctricos



**Los aparatos eléctricos pueden producir una descarga eléctrica. Para reducir este riesgo, no abra ninguna cubierta ni abra tampoco ningún otro accesorio de hardware suministrado por Miltenyi Biotec.** Cualquier cubierta así como hardware accesorios deberán ser retirados únicamente por personal autorizado. Se debe tener especial cuidado cuando se manejen líquidos. Limpie inmediatamente los líquidos vertidos. Impida que éstos accedan al interior del aparato. Desenchufe el cable de electricidad antes de proceder a limpiar manualmente el separador autoMACS Pro.

**Existe un riesgo potencial en caso de usar separador autoMACS Pro abierto, que se haya caído o que esté averiado, si se han derramado líquidos en el equipo, si se ha colado algún objeto por las ranuras de ventilación o si ha caído algo dentro del equipo.** Si salen llamas o humo, apague inmediatamente el separador autoMACS Pro, desenchúfelo y póngase en contacto con un proveedor de servicios de Miltenyi Biotec autorizado o con el servicio técnico de Miltenyi Biotec. Está expresamente prohibido utilizar un instrumento estropeado o cuyo cable de corriente esté dañado.

El separador autoMACS Pro está diseñado para ser usado exclusivamente en interior. No utilice el equipo en áreas clasificadas como peligrosas como ambientes con alta concentración de oxígeno. El instrumento no debería ser colocado cerca de radiadores, rejillas de calor, estufas o cualquier otra pieza de equipamiento (incluidos los amplificadores) que produzca calor. Permita que circule suficiente aire alrededor del separador autoMACS Pro – deje al menos 15 cm de separación en todas direcciones – mientras está en funcionamiento para garantizar que el instrumento se enfríe adecuadamente. Evite la exposición directa a la luz solar. Las ranuras y aberturas del instrumento sirven para que se ventile y no deben ser bloqueadas o cubiertas, puesto que contribuyen a un funcionamiento seguro del separador autoMACS Pro, evitando que se recaliente. No introduzca ningún cuerpo extraño por

las aberturas del instrumento.

No use el instrumento en un lugar húmedo. Evite la elevada humedad o la condensación y proteja a la máquina de salpicaduras. Desenchufe el separador autoMACS Pro de la toma de corriente antes de proceder a su limpieza. No emplee productos de limpieza líquidos ni aerosoles y use siempre un trapo húmedo.

El instrumento está equipado con un tipo de enchufe de tres varillas que tiene un tercer contacto para toma de tierra. Este enchufe sólo encaja en una toma conectada a tierra. Se trata de una medida de seguridad. No intente enchufarlo en una toma de electricidad no conectada a tierra. Si el enchufe no encaja, póngase en contacto con un electricista para que reemplace la toma de corriente.

Sólo se debería maniobrar el instrumento utilizando la fuente eléctrica indicada en la etiqueta con los valores eléctricos del producto. Si tiene alguna pregunta sobre qué tipo de fuente eléctrica utilizar, póngase en contacto con su proveedor de servicios de Miltenyi Biotec autorizado o con su compañía eléctrica. No utilice alargadores o regletas. No sobrecargue la toma de corriente. La carga total del sistema no debe sobrepasar el 80% de la rama del circuito.

Asegúrese de poder acceder fácilmente tanto al interruptor principal como al conector para el cable de corriente eléctrica y de que éstos estén situados tan cerca del operario como sea posible. Si es necesario desconectar el suministro eléctrico, desenchufe el cable de la toma de corriente.

Solamente los dispositivos periféricos que cumplen con la UL 60950 pueden ser conectados con el conector RS232 rotulado con **COM**. No se utiliza el conector rotulado con **RS232/AUX**. Adicionalmente deben conectarse exclusivamente equipos originales de autoMACS Pro con los conectores rotulados con **External CAN, CAN1 y CAN2**. Los niveles de voltaje de estos conectores no debe sobrepasar los niveles de voltaje peligroso de 30 V CA y 42.4 V punta o 60 V CC. Se debe conectar solamente el cable de sensor de botella MACS Pro con el conector del sensor de botella. Con el conector **RS232/BCR** debe conectarse solamente un lector de código 2D recomendado por Miltenyi Biotec. Los dispositivos de láser externos conectados con el conector rotulado con **RS232/BCR** deben cumplir con la norma IEC 60825-1. Utilice exclusivamente cables de conexión con un largo menor a 3 m.

## Campo magnético intenso



El separador autoMACS Pro está equipado con un imán extremadamente potente. **Existe un riesgo de lesión grave para las personas que llevan marcapasos, derivaciones cerebrales o implantes médicos electrónicos.** Mantenga todos los portadores de información magnética (tarjetas de crédito, cintas magnéticas y medios de almacenamiento) y todos los equipos electrónicos (audífonos, marcapasos, instrumentos de medición y control, ordenadores y relojes) a una distancia mínima de 20 cm de la cubierta magnética. El campo magnético puede alterar o dañar dichos objetos.

## Riesgos mecánicos



No abrir las cubiertas de acceso frontal durante el servicio del dispositivo. No obstruir el movimiento del brazo automatizado y de los accesorios durante la operación. Mantener los dedos etc. lejos de todas las piezas móviles del separador autoMACS Pro y de los accesorios, para evitar aplastamientos, lesiones de corte o daños en el dispositivo. No tocar las bombas de fluido ni ajustar la tubería durante la operación del dispositivo. Desactivar siempre el dispositivo antes de ajustar cualquier parte del sistema de fluidos. El procedimiento debe pararse o interrumpirse antes de maniobrar los accesorios, p. ej. el MACS MiniSampler Plus, o antes de colocar o retirar los tubos del soporte de tubo colocado en el sampler. No omitir ninguna de las medidas o los dispositivos de seguridad.

## Riesgos de radiación óptica



El dispositivo está equipado de cuatro unidades láser de emisión superficial de cavidad vertical (VSCLs) para la detección automatizada de reactivos (clase 1M). La radiación no es visible. No mire directamente con instrumentos ópticos (por ejemplo, gafas, lupas y microscopios). Puede ser peligroso para el ojo mirar el puerto VSCL con instrumentos ópticos a una distancia de 100 milímetros.

El dispositivo también está equipado de un lector de código 2D que utiliza un láser semiconductor visible como indicador de blanco para ajustar la posición de lectura y diodos electroluminosos de gran alcance (LED) para iluminar el área de la lectura, las botellas de fluidos así como la botella de desechos. Por favor, no extraiga las cestas de las botellas.

De acuerdo con la normativa internacional IEC 62471, este sistema de lámpara tiene un valor de riesgo por exposición (EHV) de 0.91 siendo en exceso para el grupo exento de riesgos (Exempt Risk Group). La distancia de riesgo (HD) para el grupo exento de riesgos es de 61 cm. La distancia de riesgo para el Grupo de Riesgo 1 (Risk Group 1) es de 20 cm.

**No mirar directamente el láser, radiación LED, láser reflejado o radiación del LED de una superficie reflejada.** De otra manera, podría ocasionarse una lesión ocular. No dirigir intencionalmente el rayo láser a otras personas. No desmontar, modificar ni quitar el láser o la fuente de radiación LED o sus soportes de montaje. El láser o las fuentes de radiación LED no interrumpen la emisión cuando están desmontados. La radiación de unidades desmontadas puede ocasionar lesiones oculares. Tener cuidado con la trayectoria del rayo o la reflexión láser de una superficie reflejada. Durante la instalación del autoMACS Pro Separator, tener cuidado de que durante la operación la trayectoria del rayo láser no esté a la misma altura que el ojo humano.

No permitir que agua, aceite, polvo u otras sustancias ajenas se peguen a la ventana de abertura del lector 2D Code. Esto puede causar errores de lectura. Asegúrese de parar la emisión del láser antes de limpiar el escáner. De no ser así, la exposición al

láser puede ocasionar lesiones oculares. Utilizar un paño suave y seco para limpiar cualquier sustancia del escáner. No utilizar alcohol u otra sustancia de limpieza.

El autoMACS Pro Separator está clasificado como producto láser 1M de estándar IEC 60825-1.

El uso de controles, el ajuste o la realización de procedimientos con excepción de los aquí especificados puede dar lugar a una peligrosa exposición de radiación.

## Riesgos químicos y biológicos



Si se utilizan o se han utilizado sustancias biológicamente peligrosas, el operario debería utilizar el equipo de seguridad que aparece en las señales de aviso de las sustancias empleadas. Póngase guantes, ropa y gafas de seguridad para evitar el contacto con la piel y con los ojos. También proteja la boca y la nariz pues los aerosoles podrían escaparse del sistema. Un equipo de seguridad defectuoso o inadecuado puede poner en peligro al operario. El separador autoMACS Pro deberá ser manejado dentro de una campana de seguridad si se procesan sustancias peligrosas o desconocidas. Si se han utilizado sustancias peligrosas o éstas se han derramado, se debe velar por una desinfección meticulosa del sistema.

Antes de encender el instrumento siempre inspeccione todo el sistema de fluidos (todas las conexiones y tubos, válvulas, columnas, jeringas y agujas). Si detectase alguna rotura o fuga, sustituya todas las piezas dañadas antes de encender el instrumento. Si alguna parte dañada no puede ser sustituida, desconecte y no use el equipo. La falta de piezas por donde pasa material de riesgo biológico o el contacto con líquidos que han estado en dichas piezas podría ser peligroso.

Las columnas, placas, tubos de ensayo y cualquier otro objeto que haya estado en contacto con las muestras peligrosas deberán ser autoclavados antes de poder volver a ser utilizados. Los residuos líquidos deberán ser autoclavados o descontaminados usando un desinfectante industrial apropiado para el patógeno específico, por ejemplo, hipoclorito de sodio al 10%, alcohol isopropílico o etanol al 70%. La eliminación de los residuos debe cumplir la normativa nacional.

## Servicio, transporte y eliminación seguros



Salvo que el presente manual de usuario u otra documentación de Miltenyi Biotec especifique lo contrario, no revise usted mismo el separador autoMACS Pro. Las revisiones y reparaciones deben ser llevadas a cabo por personal cualificado. Las revisiones y reparaciones del separador autoMACS Pro incorrectamente realizadas pueden poner en peligro a sus usuarios, producir resultados impredecibles, derivar en un mal funcionamiento del aparato o que éste sufra daños así como causar un desgaste prematuro y reducir el tiempo de vida del instrumento pudiendo anular su garantía.

EN

DE

ES

FR

IT

Cuando se necesiten piezas de recambio o de repuesto, asegúrese de que el proveedor de servicios utiliza exclusivamente piezas originales de Miltenyi Biotec o de otros fabricantes especificados y recomendados por Miltenyi Biotec. El uso de piezas de recambio o de repuesto no autorizadas puede producir un mal funcionamiento del aparato y alterar los resultados de la separación celular. Miltenyi Biotec no cubrirá la garantía ni aceptará ninguna responsabilidad por la avería de aparatos o por los daños resultantes del uso de piezas de recambio o de repuesto inapropiadas. Una vez completado el servicio o la reparación, haga que su proveedor de servicios autorizado por Miltenyi Biotec realice todos los controles de seguridad requeridos por el proceso de reparación para asegurarse de que el instrumento está en buenas condiciones de funcionamiento.

**Utilice solo opciones y actualizaciones recomendadas por Miltenyi Biotec.**

Consulte con su representante local de Miltenyi Biotec sobre el amplio servicio del instrumento, o diríjase a [www.miltenyibiotec.com/support](http://www.miltenyibiotec.com/support).

El separador autoMACS Pro debe ser transportado con cuidado en el embalaje especificado por Miltenyi Biotec. Se pueden producir daños internos si es expuesto a vibraciones excesivas o si se cae. En caso de que sea necesario devolver el instrumento a su fabricante para su revisión, límpielo y desinfectelo de cualquier sustancia peligrosa antes de realizar el envío. Si tiene preguntas relativas a la descontaminación o el envío, póngase en contacto con el servicio de asistencia técnica.



**Información sobre la Directiva de Residuos de Aparatos Eléctricos y Electrónicos (Waste of Electrical and Electronic Equipment, WEEE)**

Por favor, al final de la vida útil de su equipo de Miltenyi Biotec disponga del mismo de acuerdo a la ley WEEE aplicable, la cual puede ser diferente según el país o región.

Los equipos eléctricos y electrónicos pueden contener sustancias peligrosas que pueden tener graves efectos perjudiciales sobre el medio ambiente y/o la salud humana. Por este motivo, todos los equipos deben ser específicamente recogidos y tratados por los centros de residuos designados y según planes de cumplimiento de la WEEE cualificada. Al asegurarse de que se está deshaciendo de su equipo eléctrico y electrónico no deseado de acuerdo con la legislación y la WEEE aplicable de disposición de residuos peligrosos, estará ayudando a preservar nuestros recursos naturales y a proteger la salud humana.

Miltenyi Biotec está comprometido con la protección del medio ambiente. Miltenyi Biotec ofrece productos que se encuentran en el final de su vida a programas de retorno de muchos países, y a socios con esquemas de cumplimiento de licencias WEEE en todo el mundo. Miltenyi Biotec le ofrece reciclar su equipo de Miltenyi Biotec en el final de su vida útil forma gratuita. Los términos y la disponibilidad de esta oferta pueden variar según la región geográfica, debido a las diferencias en los requisitos reglamentarios. Tenga en cuenta que, dependiendo del tipo y uso del equipo, pueden aplicarse requisitos adicionales.

Para más información, o si desea eliminar su equipo de Miltenyi Biotec en el final de su vida útil, por favor póngase en contacto con su representante local de Miltenyi Biotec o con el Servicio Técnico de Miltenyi Biotec.

EN

DE

ES

FR

IT



FR

## Informations de sécurité importantes

### **WARNING**

Le séparateur autoMACS Pro est conçu pour une utilisation sûre, si il est correctement installé et manié par un personnel qualifié, conformément aux mesures de sécurité générales et aux consignes libellées dans ce manuel.

### Avertissements et précautions

Les instructions de ce chapitre expliquent les risques potentiels liés à l'utilisation de l'appareil et fournissent des informations de sécurité importantes afin de réduire ces risques. Respectez strictement ces consignes pour protéger l'équipement et vous-même des risques potentiels et créer un environnement de travail sûr. La protection n'est pas garantie si cet appareil n'est pas utilisé conformément aux instructions données par le fabricant.

Les consignes de sécurité concernant la zone de travail locale, les bonnes pratiques de laboratoire, ainsi que les directives relatives à la santé, à la sécurité et à la prévention des accidents en laboratoire doivent être observées en permanence. Pour de plus amples d'informations concernant l'installation de l'équipement, veuillez vous adresser à votre organisme local responsable de l'approvisionnement en électricité, des travaux de bâtiment, de la maintenance et de la sécurité.

### Niveaux de danger

Des mots clé sont utilisés pour identifier des messages sur des détériorations matériels et de sécurité. Les mots clé suivants sont utilisés dans ce manuel.

#### **WARNING**

ou **WARNING!** indique une situation potentiellement dangereuse, pouvant entraîner la mort ou des blessures graves, si elle n'est pas évitée.

#### **CAUTION**

ou **CAUTION!** indique une situation potentiellement dangereuse pouvant causer des blessures mineures ou modérées, si elle n'est pas évitée. Il peut également servir d'alerte contre une utilisation risquée.

EN

DE

ES

FR

IT



## Symboles de sécurité

Les symboles suivants sont utilisés pour souligner des conditions qui pourraient entraîner des blessures du personnel ou une détérioration du dispositif.



Alerte de sécurité. Risque de danger. La documentation doit être consultée dans les cas où un symbole d'alerte de sécurité est mentionné afin de connaître la nature du danger potentiel et les mesures à prendre.



Risque d'un choc électrique.



Champ magnétique puissant.



Les personnes qui portent un stimulateur cardiaque ou un implant médical électronique doivent maintenir une distance de sécurité.



Risque d'écrasement et de cisaillement des membres corporels.



Radiation optique dangereuse.



Radiation laser dangereuse.



Danger biologique. Risque de contamination, si des matières biologiques potentiellement dangereuses sont utilisées.



Borne pour conducteur de protection. Ce symbole est fixé à l'intérieur de l'appareil. Cette information est destinée au personnel de service.



On (Alimentation électrique).

Off (Alimentation électrique).

## Étiquette de sécurité

Il est important d'identifier les zones de risque et symboles de sécurité sur le séparateur autoMACS Pro.

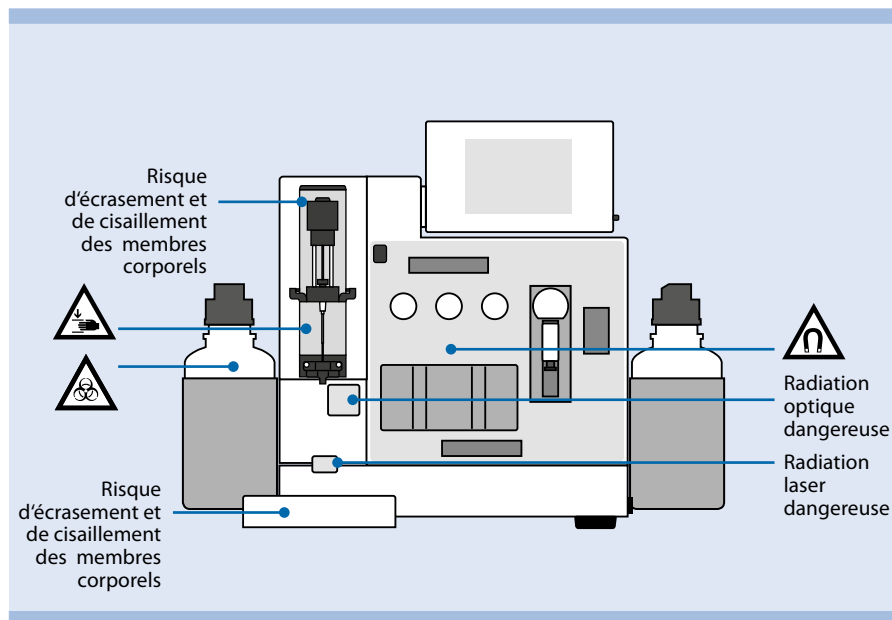

**Figure 7:** Les zones de risque et symboles de sécurité sur la face avant du séparateur autoMACS Pro.

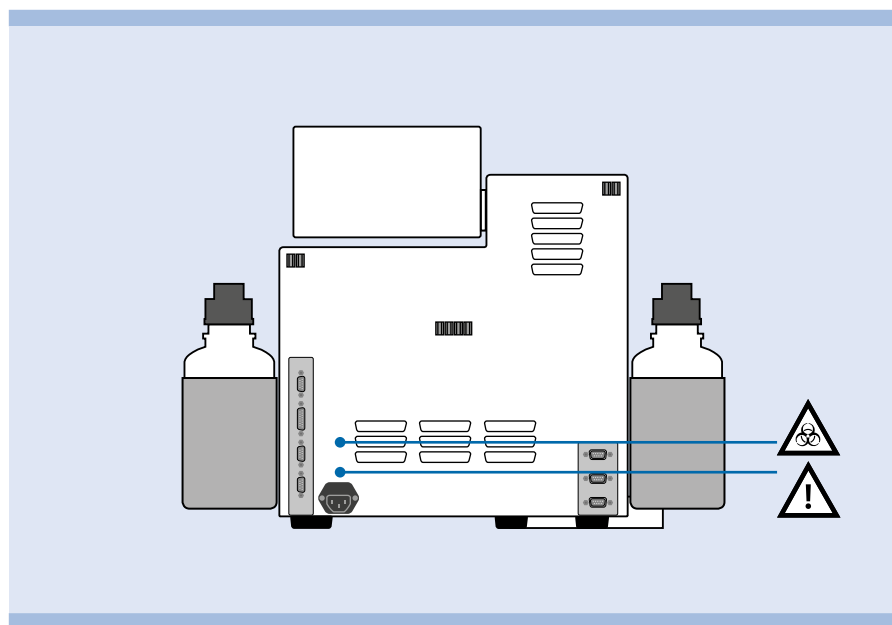

**Figure 8:** Les symboles de sécurité sur la face arrière du séparateur autoMACS Pro.

Les étiquettes et marquage de sécurité doivent être maintenus propres et lisibles. Il convient de les inspecter périodiquement et de les remplacer si elles ne sont pas lisibles ou perceptibles à une distance d'observation garantissant la sécurité du manipulateur. Contactez Miltenyi Biotec pour le remplacement des étiquettes de sécurité.

## Consignes de sécurité générales



Si l'appareil ne fonctionne pas correctement et/ou les instructions ou messages affichés vous avisent de contacter le support technique, l'utilisation sûre de l'appareil n'est plus longtemps garantie. Éteignez immédiatement l'appareil et débranchez-le de la prise électrique, puis contactez un prestataire de services Miltenyi Biotec agréé ou l'équipe de support technique de Miltenyi Biotec.

## Dangers électriques et incendie



**Les appareils électriques présentent un risque d'électrocution. Afin de réduire le risque d'électrocution, n'ouvrez aucun cache du séparateur autoMACS Pro, ni d'autres équipements accessoires fournis par Miltenyi Biotec.** Tous les caches de l'appareil et des équipements accessoires doivent être démontés par le personnel agréé uniquement. Soyez particulièrement prudent pendant la manipulation de fluides. Nettoyez immédiatement si des liquides se sont déversés. Veillez à ce que les fluides ne s'infiltrant pas à l'intérieur de l'appareil. Débranchez le câble électrique avant de nettoyer manuellement le séparateur autoMACS Pro.

**Un risque potentiel existe si le séparateur autoMACS Pro utilisé est ouvert, déformé ou endommagé, si des liquides se déversent dans l'appareil, si un objet est entré dans l'appareil par les fentes de ventilation ou si un objet a chuté dans l'appareil.** En cas d'apparition de flammes ou de fumée, déconnectez immédiatement le séparateur autoMACS Pro, débranchez l'appareil et contactez un prestataire de services Miltenyi Biotec agréé ou l'équipe de support technique de Miltenyi Biotec. Il est formellement interdit d'utiliser un appareil endommagé ou un appareil dont le câble électrique est endommagé.

Le séparateur autoMACS Pro est destiné à une utilisation intérieure uniquement. N'utilisez pas l'appareil dans des zones classées dangereuses telles que des environnements à teneur élevée en oxygène. Ne placez pas l'appareil à proximité de radiateurs, de registres de chaleur, de fours ou d'autres pièces d'équipement (amplificateurs) qui produisent de la chaleur. Veillez à ce que suffisamment d'air puisse circuler autour du séparateur autoMACS Pro – au moins 15 cm de chaque côté – pendant le fonctionnement afin de garantir le refroidissement adéquat de l'appareil. Évitez d'exposer l'appareil à un ensoleillement direct. Les encoches et les fentes de l'appareil sont prévues pour la ventilation et ne doivent jamais être bloquées ou recouvertes, car elles assurent le fonctionnement fiable du séparateur

autoMACS Pro et protègent l'appareil de la surchauffe. N'introduisez jamais d'objet étranger dans l'appareil par l'une des fentes.

N'utilisez pas l'appareil dans un endroit humide ou mouillé. Évitez l'humidité et la condensation et protégez la machine des éclaboussures. Débranchez le séparateur autoMACS Pro avant le nettoyage. N'utilisez pas d'agents nettoyants liquides ou en aérosol; utilisez toujours un chiffon humide.

L'appareil est équipé d'une fiche électrique trifilaire avec mise à la terre dont la troisième borne est prévue pour relier l'appareil à la terre. Cette fiche fonctionne uniquement dans une prise de courant avec contact de mise à la terre. Il s'agit d'un dispositif de sécurité. N'essayez pas d'insérer la fiche dans une prise de courant sans contact de mise à la terre. Si vous ne pouvez pas insérer la fiche dans la prise de courant, veuillez vous adresser à votre électricien local qui remplacera la prise de courant.

Ne faites fonctionner l'appareil qu'à partir d'une source électrique indiquée sur la plaque signalétique du produit. Si vous avez des questions sur le type de courant électrique que vous pouvez utiliser, contactez votre prestataire de services Miltenyi Biotec agréé ou votre fournisseur d'électricité local. N'utilisez pas de rallonges ni de barrettes de connexion. Ne surchargez pas la prise électrique. La charge totale du système ne doit pas dépasser 80% de la valeur nominale du circuit de dérivation.

Assurez-vous que l'interrupteur principal et le connecteur du câble électrique soient facilement accessibles et placés aussi près que possible de l'opérateur de l'appareil. S'il s'avère nécessaire de déconnecter l'alimentation électrique, débranchez le câble.

Seuls les appareils périphériques conformes à la norme UL 60950 peuvent être branchés au connecteur RS232 étiqueté **COM**. Le connecteur étiqueté **RS232/AUX** n'est pas utilisé. De plus, seuls des appareils autoMACS Pro originaux doivent être raccordés aux connecteurs étiquetés **External CAN, CAN1** et **CAN2**. Le niveau de tension mesuré sur ces connecteurs ne doit pas dépasser le niveau de tension dangereux de 30 V<sub>eff</sub> ainsi qu'un pic de 42,4 V ou 60 V DC. Seul le câble de capteur de flacon autoMACS Pro peut être raccordé au connecteur étiqueté **Bottle Sensor**. Seul un lecteur de code 2D recommandé par Miltenyi Biotec peut être branché au connecteur **RS232/BCR**. Les appareils laser externes raccordés au connecteur étiqueté **RS232/BCR** doivent répondre à la norme IEC 60825-1. Utilisez uniquement des câbles de connexion de 3 mètres de longueur maximum.

## Champ magnétique puissant



Le séparateur autoMACS Pro est équipé d'un aimant extrêmement puissant. **Il y a un risque d'accident pour Les personnes qui portent un stimulateur cardiaque, une dérivation cérébrale ou un implant médical électronique.** Veuillez à laisser un espace d'au moins 20 cm entre le cache de l'aimant et les supports d'information magnétiques (cartes de crédit, bandes magnétiques et supports de données) ainsi que l'équipement électronique (appareils auditifs, pacemakers, dispositifs de mesure

et de contrôle, ordinateurs et montres). Ces éléments peuvent être affectés ou endommagés par le champ magnétique.

## Dangers mécaniques



N'ouvrez pas les capots frontaux pendant le fonctionnement de l'appareil. Ne bloquez pas le mouvement du bras automatique ni des pièces correspondantes pendant le fonctionnement. N'approchez pas vos doigts, etc. des pièces mobiles du séparateur autoMACS Pro et des pièces correspondantes afin d'éviter toute blessure ainsi que toute détérioration de l'appareil due à l'écrasement et au cisaillement. Ne touchez pas les pompes à liquide et ne modifiez pas les tuyaux pendant le fonctionnement de l'appareil. Déconnectez toujours l'appareil avant de modifier une partie du système fluide. Stoppez ou annulez toujours le processus avant de manipuler les appareils supplémentaires comme le mini-échantillonneur MACS ou de charger/retirer les éprouvettes du râtelier à éprouvettes placé sur l'échantillonneur. Ne bloquez pas les dispositifs de sécurité et respectez les mesures de sécurité.

## Dangers de radiation optique



L'appareil est équipé pour la détection automatique de porte-éprouvettes (classe 1M) par quatre diodes laser à émission par la surface à cavité verticale (VCSEL). Le rayonnement est invisible. Ne pas regarder directement dans ce rayon au travers d'instruments optiques (p. ex. lentilles, verres grossissants et microscopes). Regarder dans l'ouverture du VCSEL à une distance inférieure à 100 mm au travers d'instruments optiques peut endommager les yeux.

L'appareil est également équipé d'un lecteur de code 2D utilisant un laser à semi-conducteur visible comme pointeur pour le réglage de la position de lecture ainsi que de diodes électroluminescentes (DEL) haute puissance pour l'éclairage du champ de lecture, des bouteilles de réactifs ainsi que de la poubelle. Ne pas démonter le support à bouteille.

Selon la norme internationale IEC 62471 de sécurité photobiologique, ce système de DEL a une valeur de risque d'exposition (EHV) de 0.91 et est au dessus du groupe de risque 0 (exempt risque). La distance de risque (HD) pour le groupe de risque 0 est de 61 cm. La distance de risque pour le groupe de risque 1 (risque faible) est de 20 cm.

**Ne diriger le regard ni dans le rayon laser ou DEL direct, ni le rayon laser ou DEL réfléchi sur une surface de miroir.** Sinon, des lésions oculaires peuvent en résulter. Ne pas diriger intentionnellement le rayon laser sur d'autres personnes. Ne pas démonter, échanger ni retirer des sources de rayon laser ou DEL encastrées ni leur support. Les sources de rayon laser ou DEL ne cessent pas forcément d'émettre un rayonnement une fois démontées.

Le rayonnement d'appareils démontés peut entraîner des lésions oculaires. Prendre garde au chemin optique du rayon laser ou de sa réflexion sur une surface de miroir. Veiller lors de l'installation de l'autoMACS Pro Separator à ce que le chemin optique rayon laser ne se trouve pas à hauteur des yeux de personnes pendant le service.

Eviter que de l'eau, de l'huile, de la poussière ou d'autres corps étranger adhèrent sur la fenêtre de lecture du lecteur de code 2D, comme ceci risque d'entraîner des erreurs de lecture. S'assurer avant le nettoyage du scanner qu'aucun rayon laser n'est plus émis. La manipulation du laser risque sinon de provoquer des lésions oculaires. Utiliser un chiffon doux pour essuyer des substances sur le scanner. Ne pas utiliser d'alcool ou d'autres produits de nettoyage.

L'autoMACS Pro Separator est désigné comme produit laser de la classe 1M selon la norme IEC 60825-1.

L'utilisation d'organes de commande autres que ceux mentionnés dans ce document ainsi que toute adaptation ou utilisation d'autres procédés que ceux mentionnés dans ce document peuvent dégager des rayonnements dangereux.

## Dangers chimiques et biologiques



Si une matière nocive pour l'organisme est ou a été utilisée, l'opérateur doit choisir et porter un équipement de protection individuelle conforme aux avertissements et aux précautions pour les substances utilisées. Portez des gants de protection, des vêtements de protection et des lunettes de sécurité afin d'éviter tout contact avec la peau et les yeux. Protéger aussi la bouche et le nez des aérosols qui pourraient provenir du système. Un équipement de sécurité défectueux ou inadéquat peut mettre l'opérateur en danger. Le séparateur autoMACS Pro doit être manipulé dans un couvercle de protection si des matières dangereuses ou inconnues sont traitées. Si une matière dangereuse a été utilisée ou s'est déversée, prenez les précautions appropriées pour décontaminer soigneusement le système.

Toujours vérifier le système fluïdique (le jeu complet de tubulures, les bouteilles et leurs bouchons, les valves, les colonnes, la valve diluteur et les aiguilles) avant d'allumer l'instrument. Si des fuites sont détectées, remplacer les pièces endommagées avant d'allumer l'instrument. Si les pièces ne peuvent pas être remplacées, débrancher l'instrument et ne pas l'utiliser. Les pièces endommagées contenant du matériel biologique infectieux ou des liquides qui ont été en contact avec un tel matériel peuvent être potentiellement dangereuses.

Les colonnes, les plaques, les tubes et tous les autres consommables qui ont été en contact avec des échantillons nocifs pour l'organisme doivent être traités à l'autoclave avant l'élimination. Les déchets liquides doivent être traités à l'autoclave ou décontaminés à l'aide d'un désinfectant adapté à l'agent pathogène spécifique, par ex. 10% eau de Javel, alcool isopropylique ou 70% d'éthanol. L'élimination des déchets doit être effectuée conformément aux réglementations locales.

## Maintenance, transport et élimination



N'effectuez pas vous-même l'entretien du séparateur autoMACS Pro, sauf autre consigne spécifique donnée dans ce mode d'emploi ou dans un autre document de Miltenyi Biotec. L'entretien et la réparation doivent être effectués par des réparateurs qualifiés. Tout entretien ou toute réparation inappropriée ou incorrecte de votre séparateur autoMACS Pro peut mettre en danger les utilisateurs, fournir des résultats imprévisibles, entraîner le dysfonctionnement ou la détérioration de l'appareil, son usure prématurée et réduire la durée de vie de l'appareil, ainsi qu'annuler votre garantie.

Si des pièces de remplacement ou de rechange sont requises, assurez-vous que le prestataire de services utilise exclusivement des pièces Miltenyi Biotec d'origine ou des pièces de fabricants tiers spécifiées et recommandées par Miltenyi Biotec. L'utilisation de pièces de remplacement ou de rechange non autorisées peut entraîner le dysfonctionnement de l'appareil et fausser les résultats de la séparation des cellules. Miltenyi Biotec n'accorde pas de prestation de garantie ou décline toute responsabilité pour les pannes et les dommages de l'appareil résultant de l'utilisation de pièces de remplacement ou de rechange inappropriées. Une fois les travaux d'entretien ou de réparation achevés, demandez à votre prestataire de services Miltenyi Biotec agréé d'effectuer tous les contrôles de sécurité requis par la procédure de réparation afin de garantir que l'appareil est parfaitement opérationnel.

**Utilisez uniquement des options et extensions recommandées par Miltenyi Biotec.** Renseignez-vous auprès de votre représentant local Miltenyi Biotec sur les arrangements extensives de support et de maintenance de l'appareil, ou bien référez vous à [www.miltenyibiotec.com/support](http://www.miltenyibiotec.com/support).

Le séparateur autoMACS Pro doit être transporté avec soin dans un emballage spécifié par Miltenyi Biotec. Un dommage interne peut survenir si l'appareil est soumis à des vibrations excessives ou s'il chute. Si l'appareil doit être réexpédié pour être remis en état, décontaminez l'appareil afin d'éliminer toute matière dangereuse avant le transport. Si vous avez des questions concernant la propre décontamination ou l'expédition, n'hésitez pas à contacter notre service technique assistance.



### Déchets d'Équipements Électriques et Electroniques (DEEE) – Information Client

Pensez à recycler vos produits Miltenyi Biotec en fin de vie en conformité avec la directive DEEE en vigueur dans votre pays.

Les équipements électriques et électroniques peuvent contenir des substances dangereuses, qui peuvent avoir un effet néfaste sur l'environnement et / ou la santé humaine. C'est pourquoi tous les équipements doivent être spécifiquement collectés et traités par les centres désignés et ce en conformité avec la « Réglementation DEEE ». En vous assurant que vous éliminez vos équipements électriques et électroniques en accord avec la législation en vigueur, vous contribuez à préserver

nos ressources naturelles et à protéger la santé humaine.

La protection de l'environnement est au cœur de nos préoccupations. Ainsi, nous finançons de nombreux programmes de collecte et de recyclage des équipements électriques que nous mettons sur le marché, en reversant une partie du prix de vente de nos produits à des éco-organismes agréés à travers le monde. Miltenyi Biotec vous permet de recycler gratuitement vos équipements Miltenyi Biotec en fin de vie. Les conditions et la disponibilité de cette offre varient selon les pays et les différentes exigences réglementaires. Selon le type et l'utilisation de votre équipement, des exigences supplémentaires peuvent s'appliquer. Pour plus d'informations, ou si vous souhaitez recycler votre équipement Miltenyi Biotec en fin de vie, contactez votre interlocuteur Miltenyi Biotec ou notre support technique.







## Importanti istruzioni di sicurezza



**WARNING**

Il separatore autoMACS Pro Separator è stato realizzato per garantire un uso sicuro, se installato correttamente, impiegato da personale specializzato e secondo la normativa generale di sicurezza e le istruzioni d'impiego contenute in questo manuale.

### Avvisi e precauzioni

Le linee guida riportate nella presente sezione illustrano i potenziali rischi associati al funzionamento dello strumento e forniscono importanti informazioni in materia di sicurezza atte a ridurre al minimo detti rischi. Seguendo scrupolosamente le istruzioni, è possibile proteggere se stessi e le attrezzature dai possibili pericoli e garantire un ambiente di lavoro sicuro. Qualora lo strumento venga impiegato in modo non conforme alle istruzioni fornite dal fabbricante, la sicurezza potrebbe risultare compromessa.

Vanno sempre osservate le istruzioni di sicurezza sul luogo di lavoro, le procedure di laboratorio e le norme relative alla salute e alla sicurezza del laboratorio, nonché alla prevenzione degli infortuni. Per ulteriori informazioni relative all'installazione della strumentazione, contattare le autorità locali competenti per la fornitura di energia elettrica, in materia di edilizia, manutenzione o sicurezza.

### Livelli di pericolo

Segnali di avviso sono in uso per identificare un uso sicuro e messaggi in caso di danni a cose personali. I seguenti segnali saranno in uso in questo manuale.

**WARNING**

o **WARNING!** indica una situazione potenzialmente pericolosa, che, se non evitata, potrebbe causare morte o gravi danni.

**CAUTION**

o **CAUTION!** indica una situazione potenzialmente pericolosa, che, se non evitata, potrebbe causare danni minori e lesioni moderate. Può essere impiegato per segnalare procedure pericolose.

EN

DE

ES

FR

IT

## Simboli di sicurezza

I seguenti simboli sono impiegati per sottolineare condizioni che potrebbero causare lesioni a persone o danni all'attrezzatura.



Avviso di sicurezza. Rischio di pericolo. Consultare il manuale di istruzioni ogni volta che questo simbolo di sicurezza viene utilizzato, per identificare la natura del potenziale pericolo e stabilire quali azioni intraprendere.



Rischio di scosse elettriche.



Forte campo magnetico.



Portatori di pacemaker o dispositivi medici elettronici devono mantenere una adeguata distanza di sicurezza.



Rischio di schiacciamento o di taglio di parti del corpo.



Radiazione ottica pericolosa.



Radiazione laser pericolosa.



Rischio biologico. Rischio di contaminazione se è in uso materiale biologico potenzialmente pericoloso.



Morsetto di protezione. Questo simbolo è applicato internamente allo strumento. Si tratta di informazioni per il personale di servizio.



On (Alimentazione).

Off (Alimentazione).

## Etichetta di sicurezza

Prendere visione dei punti critici e dei simboli di sicurezza del autoMACS Pro Separator Instrument.

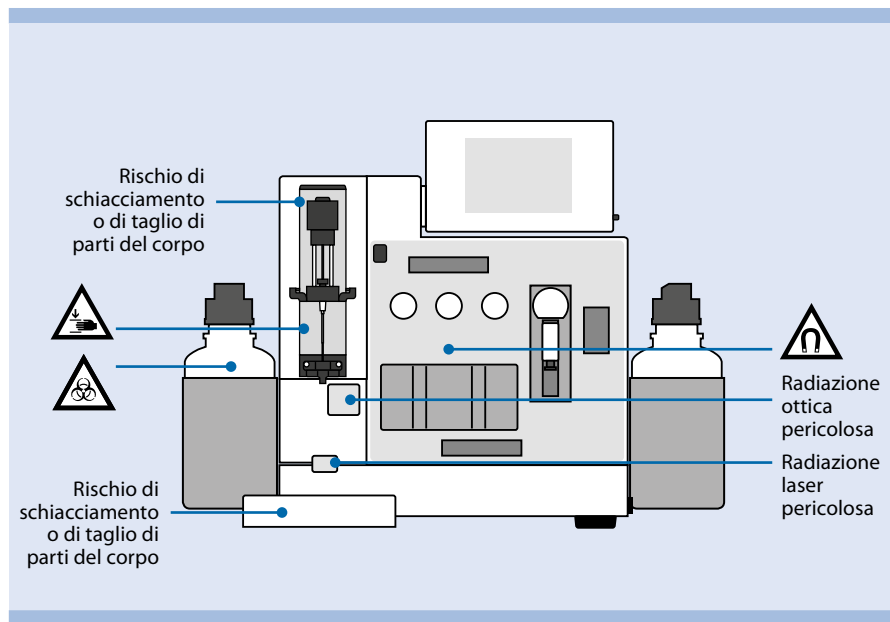

**Figure 9:** Punti critici e posizioni dei simboli di sicurezza sulla parte frontale del autoMACS Pro Separator.

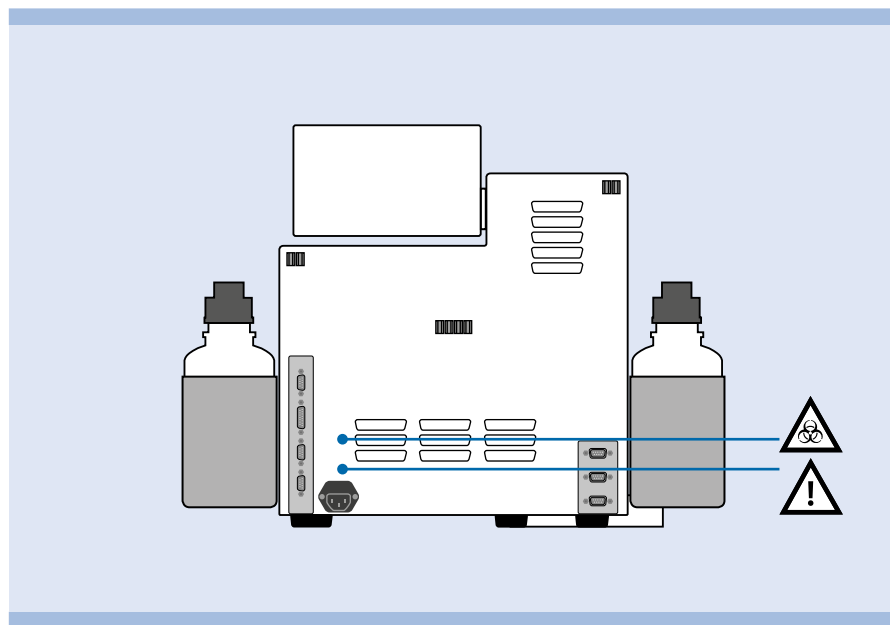

**Figure 10:** Posizione dei simboli di sicurezza sulla parte posteriore del autoMACS Pro Separator.

Le etichette di sicurezza e i marchi di sicurezza devono essere mantenuti puliti e leggibili. Ispezionare periodicamente le etichette di sicurezza e i marchi di sicurezza e sostituirli se illeggibili o percettibili da una distanza di sicurezza. Contattare Miltenyi Biotec per delle etichette sostitutive.

## Instruzioni generali di sicurezza



Se lo strumento non funziona correttamente e/o le istruzioni visualizzate dei messaggi di avviso suggeriscono di contattare l'assistenza tecnica, non è più possibile un uso sicuro dello strumento. Si spenga immediatamente lo strumento e lo si scolleghi dalla presa di corrente, quindi si contatti il service provider Miltenyi Biotec o Miltenyi Biotec Technical Support.

## Rischi elettrici e pericolo d'incendio



**I dispositivi elettrici presentano il rischio di scosse elettriche. Per ridurre i rischi di scossa elettrica, non aprire alcun coperchio, tranne i coperchi di accesso anteriore di autoMACS Pro Separator, né altri accessori hardware forniti da Miltenyi Biotec.** Tutti gli altri coperchi dello strumento e gli accessori hardware possono essere rimossi esclusivamente da personale autorizzato. Prestare particolare attenzione quando si manipolano liquidi. Pulire immediatamente eventuali schizzi. Non lasciare che i liquidi penetrino all'interno del dispositivo. Staccare il cavo dell'alimentazione prima di pulire manualmente lo strumento autoMACS Pro Separator.

Esistono potenziali rischi in caso di utilizzo di uno strumento AutoMACS Pro Separator aperto, caduto o danneggiato, in caso di infiltrazione di liquidi all'interno dello strumento, in caso di penetrazione di oggetti nello strumento attraverso le fessure di ventilazione o in caso di inserimento accidentale di oggetti nello strumento. In caso di presenza di fiamme o fumo, spegnere immediatamente il autoMACS Pro Separator, staccare lo strumento dalla presa di corrente e contattare un rivenditore Miltenyi Biotec autorizzato o il servizio di assistenza clienti Miltenyi Biotec. È severamente vietato utilizzare uno strumento danneggiato o provvisto di cavo dell'alimentazione danneggiato.

autoMACS Pro Separator sono destinati unicamente all'impiego interno. Non utilizzare lo strumento in ambienti classificati come luoghi pericolosi, quali gli ambienti con forte concentrazione di ossigeno. Lo strumento non deve essere collocato in prossimità di radiatori, stufe o altri dispositivi (inclusi gli amplificatori) che producono calore. Accertarsi che via sia un'adeguata circolazione d'aria attorno al autoMACS Pro Separator, mantenendo uno spazio libero di almeno 15 centimetri su ogni lato durante il funzionamento, onde assicurare un adeguato raffreddamento dello strumento. Evitare l'esposizione diretta ai raggi solari. Le fessure e le aperture dello strumento sono necessarie per la ventilazione e non devono essere in alcun caso ostruite o coperte, poiché garantiscono il funzionamento corretto del

autoMACS Pro Separator e proteggono il dispositivo dal surriscaldamento. Non inserire mai corpi estranei nelle aperture dello strumento.

Non utilizzare lo strumento in ambienti bagnati o umidi. Evitare ambienti ad elevata umidità o condizioni di condensa e proteggere lo strumento dagli schizzi d'acqua. Staccare il autoMACS Pro Separator dalla presa di corrente prima di eseguire la pulizia. Non utilizzare detergenti liquidi o aerosol; utilizzare sempre un panno umido.

Lo strumento è dotato di un sistema di alimentazione a tre fili ed è provvisto di spina con un terzo polo per la messa a terra. La spina può essere inserita unicamente in una presa di corrente con messa a terra, per ragioni di sicurezza. Non cercare di inserire la spina in una presa sprovvista di messa a terra. Qualora non riusciate ad inserire la spina nella presa, vi consigliamo di contattare il vostro elettricista di fiducia per sostituire la presa.

Lo strumento deve essere alimentato unicamente dalla fonte indicata sulla targa relativa alle caratteristiche di alimentazione del prodotto. In caso di domande sul tipo di alimentazione da usare, contattare il rivenditore Miltenyi Biotec autorizzato o la società elettrica locale. Non utilizzare prolunghe o ciabatte multi-presa. Non sovraccaricare la presa di corrente. Il carico complessivo del sistema non deve superare l'80% della potenza del circuito.

Accertarsi che l'interruttore principale e l'attacco del cavo dell'alimentazione siano facilmente accessibili e posti quanto più vicino possibile all'operatore dello strumento. Qualora si renda necessario interrompere l'alimentazione, staccare il cavo dalla presa di corrente.

Soltanto le periferiche conformi a UL 60950 possono essere collegate al connettore RS232 contrassegnato con **COM**. Il connettore contrassegnato come **RS232/AUX** non è in uso. È inoltre possibile collegare soltanto apparecchi autoMACS Pro originali ai connettori contrassegnati con **External CAN**, **CAN1** e **CAN2**. I livelli di tensione su questi connettori non devono superare i livelli di tensione ammessi pari a 30 V rms e 42,4 V di picco o 60 V cc. Al connettore del **sensore flacone** può essere esclusivamente collegato il cavo del sensore del flacone autoMACS Pro.

Al connettore **RS232/BCR** può essere collegato soltanto un lettore per codice 2D raccomandato da Miltenyi Biotec. I dispositivi laser esterni collegati al connettore contrassegnato come **RS232/BCR** devono essere conformi alla norma IEC 60825-1. Utilizzare unicamente cavi di connessione inferiori ai 3 metri di lunghezza.

## Forte campo magnetico



autoMACS Pro Separator è provvisto di un magnete estremamente potente. **Esiste un forte rischio per la salute di portatori di pacemaker, drenaggi cerebrali o impianti medicali.** Tenere i supporti magnetici (come carte di credito, nastri magnetici e supporti di memorizzazione) e i dispositivi elettronici (come apparecchi acustici, pacemaker, strumenti di misurazione e controllo, computer e orologi) ad

una distanza minima di 20 cm dal coperchio del magnete. Questi oggetti potrebbero essere danneggiati o il loro funzionamento essere compromesso dal campo magnetico.

## Rischi meccanici



Non aprire i coperchi di accesso anteriore mentre il dispositivo è in funzionamento. Non impedire il movimento del braccio automatizzato e degli accessori hardware durante il funzionamento. Tenere le dita, ecc., lontano da tutte le parti in movimento del dispositivo autoMACS Pro Separator e degli accessori hardware, per evitare lesioni da schiacciamento e ferite da taglio o danni al dispositivo. Non toccare le pompe dei liquidi e non spostare i tubi mentre il dispositivo è in funzione. Spegnerne sempre il dispositivo prima di regolare eventuali parti del sistema della fluidica. Interrompere o sospendere sempre una procedura prima di maneggiare gli accessori hardware, ad es. il campionatore MACS MiniSampler Plus, o prima di caricare/rimuovere le provette dal portaprovette collocato sul campionatore. Non bypassare alcun dispositivo o misura di sicurezza.

## Rischi di radiazioni ottiche



L'apparecchio è dotato di quattro laser a emissione superficiale a cavità verticale (VSCL) per il rilevamento automatizzato (classe 1M). La radiazione non è visibile. Non osservare direttamente il laser con strumenti ottici (p. es. lenti, lenti di ingrandimento e microscopi). Osservando la porta VSCL a una distanza inferiore a 100 mm con uno strumento ottico si potrebbero danneggiare i propri occhi.



L'apparecchio è dotato anche di un lettore di codici 2D dotato di un laser a semiconduttore visibile come puntatore per regolare la posizione di lettura e di potenti diodi luminosi (LED) per illuminare la zona di lettura e le bottiglie per i fluidi così come quella per la bottiglia del liquido di scarto. Non rimuovere i cestelli per le bottiglie.

Rispetto allo standard IEC 62471 la lampada ha un valore di rischio relativo all'esposizione (EHV) pari a 0.91 ed è in eccesso rispetto al Gruppo Esente da Rischio. La distanza a rischio (HD) per il Gruppo Esente da Rischio è 61 cm. La distanza a rischio per il Gruppo a Rischio 1 è di 20 cm.

**Non guardare direttamente le radiazioni di diodi laser o LED o le radiazioni di diodi laser o LED riflesse da una superficie a specchio.** In caso contrario si potrebbero danneggiare i propri occhi. Non rivolgere intenzionalmente il raggio laser verso altre persone. Non smontare, modificare o rimuovere le sorgenti di radiazioni laser o LED installate o le loro staffe di montaggio. Le sorgenti di radiazioni laser o LED non cessano automaticamente di emettere radiazioni una volta smontate.

Le radiazioni di unità smontate possono essere causa di lesioni agli occhi. Fare

attenzione al percorso del raggio laser o a riflessi da una superficie a specchio. Durante l'installazione del autoMACS Pro Separator accertarsi che il percorso del raggio laser non si trovi alla stessa altezza degli occhi di chi esegue il lavoro.

Evitare che acqua, grasso, polvere o altre sostanze estranee si depositino sulla finestra di lettura del lettore di codici a barre 2D. Ciò potrebbe comportare errori di lettura. Accertarsi di aver arrestato l'emissione laser prima di pulire il lettore. Un'esposizione al raggio laser potrebbe danneggiare i propri occhi. Utilizzare un panno morbido e asciutto per rimuovere qualsiasi sostanza dal lettore di codici a barre. Non utilizzare alcol o altre sostanze detergenti.

Il autoMACS Pro Separator è classificato come prodotto laser della classe 1M secondo lo standard IEC 60825-1.

L'utilizzo di comandi o regolazioni o l'esecuzione di procedure diverse da quanto qui specificato può essere causa di esposizione a radiazioni pericolose.

## Rischi chimici e biologici



Qualora si utilizzi o sia stato usato del materiale a rischio biologico, l'operatore deve indossare dispositivi di protezione personale conformi alle avvertenze e alle precauzioni relative alle sostanze impiegate. Indossare guanti protettivi, indumenti e occhiali di protezione per prevenire il contatto con la pelle e gli occhi. Proteggere sempre la bocca ed il naso dagli aerosol che possono provenire dal sistema. L'impiego di dispositivi di protezione difettosi o inadeguati rappresenta un rischio per l'incolumità dell'operatore. Lo strumento autoMACS Pro Separator va utilizzato con uno schermo protettivo in caso di trattamento di materiali sconosciuti o pericolosi. Qualora sia stato usato o versato del materiale pericoloso, il sistema deve essere accuratamente decontaminato.

Ispezionare sempre il sistema fluidico (il sistema di tubi, le bottiglie e le relative chiusure, le valvole, le colonne, il dispositivo di diluizione e gli aghi) prima di accendere lo strumento. In caso di perdita di liquidi, sostituire le parti danneggiate prima di accendere lo strumento. Nel caso non sia possibile sostituire le parti danneggiate, disconnettere lo strumento e non utilizzarlo. Il malfunzionamento di parti che contengono materiale potenzialmente infettivo o liquidi venuti in contatto con tali materiali possono rappresentare un pericolo.

Le colonne, le piastre, le provette e tutti gli altri materiali di consumo entrati in contatto con campioni a rischio biologico vanno sterilizzati in autoclave prima di essere smaltiti. I rifiuti liquidi vanno autoclavati o decontaminati utilizzando un disinfettante idoneo per il patogeno specifico, ed es. candeggina al 10%, alcol isopropilico o etanolo al 70%.

Lo smaltimento dei rifiuti deve avvenire in conformità alle disposizioni locali vigenti.

EN

DE

ES

FR

IT



## Manutenzione, trasporto e smaltimento sicuri



Se non diversamente indicato nel presente manuale d'uso o in altri documenti forniti da Miltenyi Biotec, non eseguire autonomamente la manutenzione del vostro autoMACS Pro Separator. Gli interventi di manutenzione e riparazione devono essere eseguiti da personale qualificato. Interventi di manutenzione e riparazione scorretti o impropri del autoMACS Pro Separator possono rappresentare un pericolo per l'incolumità degli operatori, avere conseguenze imprevedibili, causare malfunzionamenti o danni, provocare l'usura prematura e una minore durata di esercizio dello strumento, nonché invalidare la garanzia.

Qualora si rendano necessari la sostituzione o l'impiego di pezzi di ricambio, accertarsi che il tecnico utilizzi unicamente pezzi di ricambio originali Miltenyi Biotec o ricambi di altri fabbricanti specificati e raccomandati da Miltenyi Biotec. L'impiego di pezzi di ricambio non autorizzati può causare il malfunzionamento del dispositivo e compromettere il risultato della separazione cellulare. Miltenyi Biotec non fornisce alcuna garanzia né si assume la responsabilità per eventuali guasti o danni derivanti dall'impiego di pezzi di ricambio inappropriati. Al termine dell'intervento di assistenza o di riparazione, chiedere al tecnico Miltenyi Biotec autorizzato di eseguire tutti i controlli di sicurezza previsti dalla procedura di riparazione, onde assicurarsi che lo strumento funzioni correttamente.



### **Si usino solo opzioni ed aggiornamenti raccomandati da Miltenyi Biotec.**

Si chiedano informazioni al rappresentante locale di Miltenyi Biotec in merito al servizio esteso di strumenti Miltenyi Biotec's e le modalità di supporto, o ci si riferisca a [www.miltenyibiotec.com/support](http://www.miltenyibiotec.com/support).

Lo strumento autoMACS Pro Separator va trasportato con cautela in imballaggi specificati da Miltenyi Biotec. In caso di cadute o di vibrazioni eccessive, lo strumento può subire dei danni interni. Qualora si renda necessario spedire lo strumento al produttore per interventi di manutenzione, decontaminare lo strumento da eventuali materiali pericolosi prima della spedizione. In caso di domande circa la decontaminazione o il trasporto adeguati, contattare l'assistenza tecnica.

Informazioni per i clienti riguardo lo smaltimento delle apparecchiature elettriche ed elettroniche secondo le normative WEEE (Waste of Electrical and Electronic Equipment)

Si prega di smaltire i prodotti Miltenyi Biotec in disuso secondo le disposizioni di legge riguardanti lo smaltimento di apparecchiature elettriche ed elettroniche (WEEE) e dei rifiuti pericolosi, che possono differire da paese a paese.

Le apparecchiature elettriche ed elettroniche possono contenere sostanze pericolose, che possono avere un grave effetto dannoso per l'ambiente e / o la salute umana. È per questo che tutte le attrezzature devono essere specificamente raccolte e trattati da centri di smaltimento abilitati e qualificati in conformità con la normativa WEEE. Il corretto smaltimento delle apparecchiature elettriche ed elettroniche secondo le disposizioni di legge WEEE e dei rifiuti pericolosi, possono

aiutare a preservare le risorse naturali e a tutelare la salute umana.

Miltenyi Biotec si impegna a proteggere l'ambiente. Miltenyi Biotec offre programmi per lo smaltimento dei prodotti dismessi in molti paesi e partner accreditati per lo smaltimento secondo le normative WEEE in tutto il mondo. Miltenyi Biotec consente di riciclare le apparecchiature Miltenyi Biotec gratuitamente. Le condizioni e la disponibilità di questa offerta variano da zona a zona a causa di differenze legislative. Si prega di notare che, a seconda del tipo e dell'utilizzo delle apparecchiature, possono essere necessari requisiti aggiuntivi. Per ulteriori informazioni, o se si desiderassero smaltire le apparecchiature Miltenyi Biotec in disuso, si prega di contattare il Responsabile di Zona o il Supporto Tecnico Miltenyi Biotec.



# 1

## Introduction

### 1.1 MACS® Technology – the gold standard in cell separation

MACS® Technology has become the standard method in cell separation. It is based on

- MACS® MicroBeads, highly specific antibodies coupled to superparamagnetic 50 nm particles,
- MACS Columns containing a matrix of ferromagnetic spheres, and
- MACS Separators providing a strong magnetic field.

Cells in a single-cell suspension are paramagnetically labeled with MACS MicroBeads. The colloidal suspension of MACS MicroBeads allows easy handling and short incubation times. Cells can be separated in less than 30 minutes. As minimal amounts of MicroBeads are required for magnetic labeling, a large number of epitopes remains available for fluorescent labeling and subsequent cell analysis. Labeling with MACS MicroBeads and fluorochrome-conjugated antibodies can be performed simultaneously, which further decreases handling times. MACS MicroBeads are non-toxic, biodegradable and do not need to be removed from cells after the separation process. MicroBeads do not alter structure, function, or activity status of labeled cells.

When a MACS Column is placed in a MACS Separator, the ferromagnetic spheres amplify the magnetic field by 10,000-fold, thus inducing a high gradient within the column. This magnetic field is strong enough to retain cells that are labeled with minimal amounts of MACS MicroBeads, while unlabeled cells pass through and are collected as the negative fraction.

Columns rapidly demagnetize when the column is removed from the separator, or in case of the autoMACS® Pro Separator, the magnet is automatically retracted from the autoMACS Column. The labeled cells are eluted as the positive fraction.

Isolated cells can be immediately used for downstream applications, including flow cytometric analysis, cell culture, and molecular analysis. Thus, with MACS Technology both labeled and unlabeled cells can easily be isolated with high purity and recovery.

## 1.2 The autoMACS Pro Separator

The autoMACS Pro Separator is a benchtop magnetic cell sorter that allows gentle sorting of more than ten million cells per second from a sample of up to  $4 \times 10^9$  total cells. The instrument is designed for use with more than 250 MicroBead-based cell separation reagents for research applications. Thus, it is possible to choose between different cell separation strategies depending on the respective experimental design – from positive selection of abundant or rare cells, to the isolation of untouched cells by depletion of non-target cells, or to the isolation of sophisticated cell subsets by sequential sorting. Fourteen preset separation programs simplify and standardize the application.

The autoMACS Pro Separator features automated sample labeling (autolabeling), sample loading, elution of the non-labeled negative, as well as the labeled positive cell fractions. Up to six samples can be processed in one programming step. Furthermore, automated procedures for maintenance of the system are included. Different wash programs are available to rinse the columns before a new separation is performed. One pair of columns can be used for two weeks. The thin-film transistor (TFT) color touchscreen with intuitive screen menus makes operation and monitoring of the instrument user-friendly and easy. Finally, standard MACS Fluid Bottles, which are directly attached to the instrument, and ready-to-use sterile MACS Buffers are available for maximum convenience.

The autoMACS Pro Separator is supplied with the MACS MiniSampler Plus. This feature allows the sequential processing of multiple samples without further manual handling. The MACS MiniSampler Plus is supplied with three different tube racks and an additional reagent rack. The MACS MiniSampler Plus and tube racks are automatically detected by the autoMACS Pro Separator, adding to its operational efficiency.

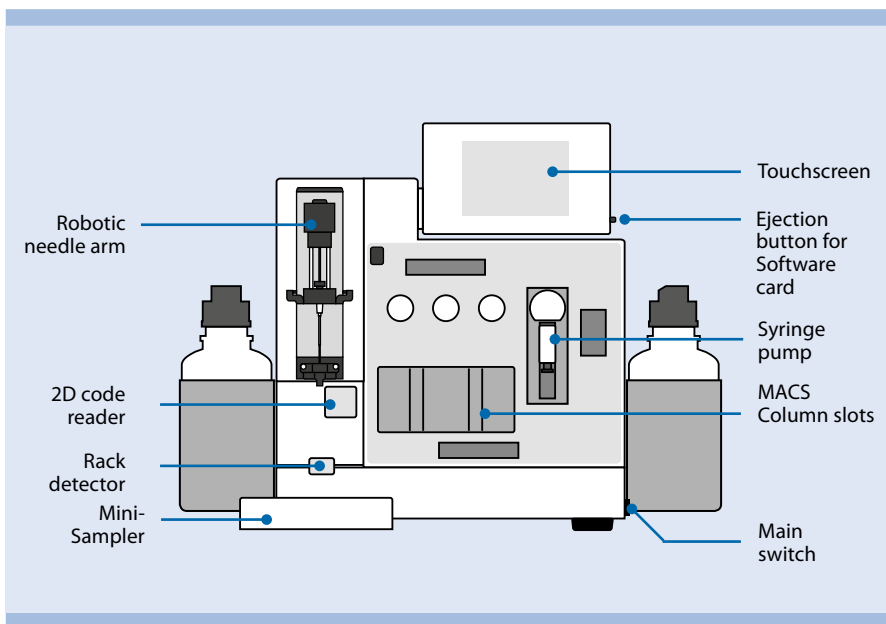

**Figure 1.1:** Front view of the autoMACS Pro Separator.

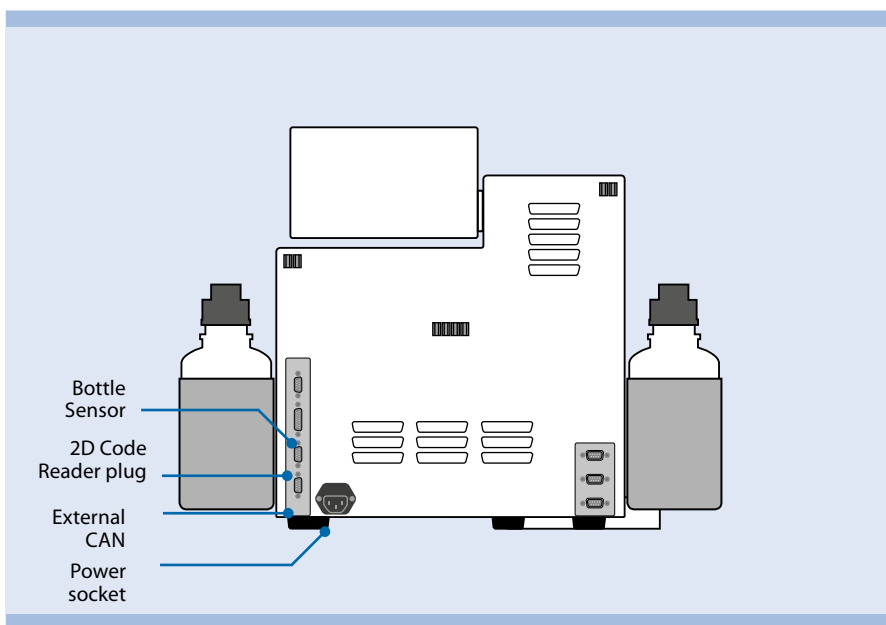

**Figure 1.2:** Back view of the autoMACS Pro Separator.



# 2

## Installation

### **WARNING**

Read the instructions in the chapter **Important safety information** and ensure that your site is properly prepared before continuing with installation and assembly. Incorrect installation can lead to the spread of fire, explosion, the risk of electric shock, or biohazards. Before operating the autoMACS Pro Separator for the first time, carefully read the user manual. Contact your local Miltenyi Biotec representative for assistance.

Do not place the autoMACS Pro Separator on an unstable table, cart, stand, tripod, or bracket. As a consequence, the instrument might fall down. This may cause serious bodily harm and/or serious damage to the instrument. Use only on a table, cart, stand, tripod, or bracket recommended by Miltenyi Biotec or sold with the instrument. Do not place the autoMACS Pro Separator within a built-in apparatus or a confined space such as a shelf rack unless the apparatus has been specifically designed to accommodate the instrument, proper ventilation is provided, and the mounting instructions for the instrument have been followed.



## 2.1 Components included in delivery

The following components are included in the delivery of the autoMACS Pro Separator – Starter Kit (# 130-092-545):

Component	Position in transportation box
autoMACS Pro Separator Instrument	Lower compartment
MACS MiniSampler Plus	Lower compartment
MACS Reagent Rack 4	Lower compartment
1 MACS Chill 5 Rack	Lower compartment
1 MACS Chill 15 Rack	Lower compartment
1 MACS Chill 50 Rack	Lower compartment
2D code reader	Built in
Memory card with software	Upper compartment
5x2 autoMACS Columns	Upper compartment
2x2 column substitutes	Built in
User manual	Upper compartment
Short instructions	Upper compartment
Pump syringe	Upper compartment
Power cord	Upper compartment
Fluid bottle sensor cables	Upper compartment
autoMACS Buffer Combination	Separate box
One-year warranty	

**Table 2.1:** Components included in delivery.

## 2.2 Materials required for operation

For daily operation, the following solutions are required: autoMACS Running Buffer, autoMACS Washing Solution and storage solution. Fluid bottles can be identified by color-code and symbols (table 2.4). For proper operation of the autoMACS Pro Separator, fluid bottles must be filled with a minimum volume of 150–200 mL. It is recommended to use ready-to-use MACS Buffers or fresh, filter-sterilized solutions to prevent potential contamination of the tubing system.

**autoMACS Columns** can be used for maximal 14 days or 100 separations, whichever comes first. Their capacity reaches up to  $2 \times 10^8$  magnetically labeled cells from up to  $4 \times 10^9$  nucleated total cells or up to 15 mL of whole blood.

The **autoMACS Running Buffer** is a ready-to-use cell separation buffer that contains azide as a preservative. To prepare an azide-free running buffer, dilute the MACS BSA Stock Solution 1:20 with autoMACS Rinsing Solution.

The **autoMACS Washing Solution** is a filter-sterilized and ready-to-use solution to rinse the fluidic system after any cell separation. It contains a detergent that dissolves cell aggregates. It has been developed for optimal cleaning of the autoMACS Pro Separator tubing system.

The **storage solution** consists of 70% analytical-grade ethanol and has to be prepared from absolute ethanol, p.a. grade, and distilled water. Do not use denatured ethanol (technical ethanol), as the autoMACS Columns are not resistant to oxidative compounds.

Product	Description	Content	Order no.
autoMACS Columns	Specifically designed columns for use with the autoMACS Pro Separator	5x2 columns	130-021-101
autoMACS Running Buffer	Cell separation buffer, containing azide as preservative	6x1.5 L	130-091-221
autoMACS Rinsing Solution	For preparation of preservative-free cell separation buffer	6x1.45 L	130-091-222
MACS BSA Stock Solution	For preparation of preservative-free cell separation buffer	6x0.75 L	130-091-376
autoMACS Washing Solution	For rinsing of the autoMACS Pro Separator's fluidic system	6x1.5 L	130-092-987
Storage solution	70% (v/v) analytical-grade ethanol in distilled water	-	-

**Table 2.2:** Materials required for operation.

## 2.3 autoMACS Pro Separator accessories

The autoMACS Pro Separator is a benchtop instrument that fits in laminar flow hoods or biosafety cabinets. The operating environment should be stable and vibration-free, dust-free, sufficiently ventilated, and free from sources of electromagnetic radiation. If the instrument is placed in a laminar flow hood, the following accessories might be required: autoMACS Pro Laminar Hood Plate (# 130-093-246) and, optionally, autoMACS Pro Angle Connector Set (# 130-093-245). The laminar hood plate provides a stable and even surface, even on potentially bending surfaces. The angle connectors reduce the depth of the instrument to 455 mm (including MACS MiniSampler Plus) for placement in a location with limited space.

Accessory	Description	Order no.
Chill 5 Rack	Chill Rack for 5 mL tubes	130-092-951
Chill 5 Racks	3× Chill Racks for 5 mL tubes	130-097-041
Chill 15 Rack	Chill Rack for 5 and 15 mL tubes	130-092-952
Chill 15 Racks	3× Chill Racks for 5 and 15 mL tubes	130-097-036
Chill 50 Rack	Chill Rack for 5, 15, and 50 mL tubes	130-092-953
Chill 50 Racks	3× Chill Racks for 5, 15, and 50 mL tubes.	130-097-037
Chill 5, 15, 50 Set	Set of three Chill Racks	130-097-038
MACS Reagent Rack 4	Accommodates 4 vials of MACS Reagents	130-094-574
Air-Filter Extension Set	Extension tube and hydrophobic air filter for the autoMACS Fluid Bottles	130-091-339
autoMACS Pro Laminar Hood Plate	Metal plate for operating the autoMACS Pro Separator in a laminar flow hood	130-093-246
autoMACS Pro Angle Connector Set	Space-saving angle adaptors for cables connecting to the autoMACS Pro Separator	130-093-245
autoMACS Pro Protection Cover	Protection foil for long-term storage of the autoMACS Pro Separator	130-093-532

**Table 2.3:** autoMACS Pro Separator accessories.

## 2.4 Unpacking the autoMACS Pro Separator

**WARNING!** Read the instructions in the chapter **Important safety information** and ensure that your site is properly prepared before continuing with installation and assembly. If there is any damage, do not use the instrument but contact your local Miltenyi Biotec representative or Miltenyi Biotec Technical Support. Incorrect installation or operation of a damaged instrument can lead to the spread of fire, explosion, the risk of electric shock or biohazards.

Read through the following instructions carefully before commencing the installation procedure. Before opening the transportation box, check for any visible external damage to the box. Check also to see if the shock and position indicators (if present) suggest incorrect transportation of the instrument. If there is apparent damage, please contact Technical Support for assistance (refer to section 11).

**Note:** Two people are required to lift the autoMACS Pro Separator. The instrument must be gripped at the base of the orange bottle baskets located at both sides of the instrument. The instrument is heavier at the front. Stabilize the front of the instrument while lifting it.

- 1 Open the box and remove the upper compartment of the packaging to reveal the instrument.



**Figure 2.1:** Upper compartment of the packaging.

- 2 Remove boxes containing the MACS MiniSampler Plus, its protective cover, and the MACS Chill Racks from the lower compartment.



**Figure 2.2:** Lower compartment of the packaging.

- 3 Remove the foam packaging from both sides of the autoMACS Pro Separator.



**Figure 2.3:** Remove the foam packaging from both sides of the autoMACS Pro.

- 4 Grip the instrument at the base of the orange bottle holders and lift it out of the box. Stabilize the front of the instrument while lifting it. Place the instrument onto a stable worktop surface, and remove the plastic bag surrounding it.



**Figure 2.4:** Two people are required to lift the autoMACS Pro.

- 5 Carefully remove the uptake needle from the foam packaging located under the touchscreen.



**Figure 2.5:** Remove the uptake needle from the foam packaging (arrow).

- 6 Place the uptake needle into its guiding at the needle arm.

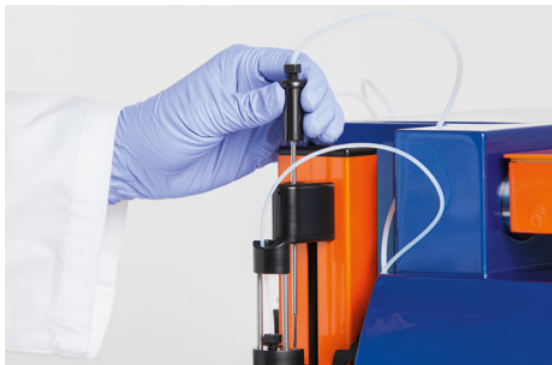

**Figure 2.6:** Place the uptake needle into its guiding.

- 7 Elevate the touchscreen and insert the memory card into the memory card slot at the right side of the touchscreen.







**Figure 2.7:** Insert the software memory card.

## 2.5 Installing and replacing fluid bottles

**WARNING!** When working with biohazardous samples, it is recommended to fill the waste bottle with 100 mL of disinfectant before use, e.g., bleach solution. For proper disposal, please follow your local regulations.

Operating the autoMACS Pro Separator requires Running Buffer, Washing Solution, and storage solution (absolute analytical-grade ethanol diluted to 70% with double-distilled water). It is recommended to operate the instrument with ready-to-use MACS Buffers (table 2.2). The autoMACS Pro Separator is delivered with four empty fluid bottles, which connect to the instrument with specifically designed bottle closures. To keep buffers sterile, each bottle closure is equipped with a hydrophobic air filter. The bottle closures consist of a fluid uptake port or in case of

the waste bottle, a fluid outlet port. To measure the filling status, bottle closures also have a sensor for measuring electrolyte conductivity. However, the storage solution (70% ethanol) does not contain electrolytes. Therefore, the filling status of the storage solution bottle cannot be measured by the instrument and must be checked visually. For your convenience, the fluid bottles, bottle closures, and fluid sensor cables are color-coded.

Bottle	Symbol
Running Buffer (blue)	
Washing Solution (green)	
Storage Solution (black)	
Waste (Red)	

**Table 2.4:** Color-coding of fluid bottles.

- 1 Install one fluid bottle at a time. Please note the corresponding color-coding (table 2.4).
- 2 Take out an empty bottle and unscrew bottle closures counter-clockwise but do not remove the bottle closures from the bottles. Do not disconnect the color-coded tubing.
- 3 Place a fresh bottle into its appropriate holder, open it and fasten the bottle closure to the new bottle. Note the color-coding and connect each sensor cable to the respective bottle closure. **Note:** To avoid contamination and spillover, do not open a fresh bottle before it is placed in its holder. Before removing a full waste bottle from the bottle holder, fasten a standard lid onto the bottle to avoid spillover.
- 4 Attach the sensor cable plug to the socket labeled **Bottle Sensor** at the back of the autoMACS Pro Separator and fasten securely.
- 5 Attach the sensor cables to the cable guide at the back of the autoMACS Pro Separator.
- 6 Connect the hydrophobic air filters (0.2  $\mu\text{m}$ ) to the appropriate connectors on the bottle closures. **Note:** Avoid any contact of the hydrophobic air filter with fluids as this may cause clogging of the filter.

## 2.6 Installing the MACS MiniSampler Plus, MACS Reagent Rack 4 and tube rack

The receiving slot for the mounting bracket of the MACS MiniSampler Plus is located at the front of the instrument. If installed correctly, the autoMACS Pro Separator automatically recognizes the MACS MiniSampler Plus upon initialization.

**Note:** Do not use the same MACS MiniSampler Plus with several different instruments, e.g. the MACSQuant® Instruments.

- 1 Open the front door of the autoMACS Pro Separator.
- 2 Tilt the MACS MiniSampler Plus and slide the mounting bracket into the receiving slot until a resistance is met. Lower the rack to a horizontal position until the rack is locked in the position.

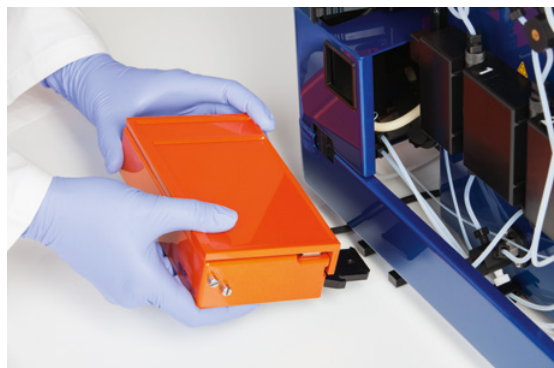

**Figure 2.8:** Insert the MACS MiniSampler Plus mounting bracket into the receiving slot.

- 3 Ensure that the MACS MiniSampler Plus is completely inserted. Secure the connection by fastening the MACS MiniSampler Plus with the supplied knurled screw.



**Figure 2.9:** Secure the MACS MiniSampler Plus.



- 4 Close the front door.
- 5 Guide the 2D code reader cable underneath the instrument. Connect the 2D code reader plug with the corresponding outlet at the back of the instrument labeled **RS232/BCR**. Fasten the screws of the connector using the screwdriver.
- 6 Guide the MACS MiniSampler Plus cable underneath the autoMACS Pro Separator and connect it to the socket labeled **External CAN** at the rear panel of the instrument. Fasten the screws of the connector using the screwdriver included in the starter kit.
- 7 Secure the MACS Reagent Rack 4 onto the MACS MiniSampler Plus into the left recess. The engagement hook has to snap into the undercut.



**Figure 2.10:** Secure the MACS Reagent Rack 4.

- 8 Set a tube rack (e.g. Chill 5 Rack) onto the MACS MiniSampler Plus into the right recess, ensuring that the rack bar code is facing the autoMACS Pro Separator.



**Figure 2.11:** Install the Chill Rack onto the MACS MiniSampler Plus.

- 9 Attach the protective cover of the MACS MiniSampler Plus. Keep the protective cover attached and closed during operation. **Note:** The protective cover is sensor-controlled. Running a separation is not possible if the protective cover is open.



**Figure 2.12:** Attach the protective cover of the MACS MiniSampler Plus.



# 3

## Switching on or off

### **WARNING**

The instrument is equipped with a three-wire electrical grounding-type plug that has a third pin for grounding. This plug only fits into a grounded power outlet. This is a safety feature. Do not try to insert the plug into a non-grounded power outlet. If you cannot insert the plug into the outlet, contact your local electrician to replace the outlet. The instrument should only be operated from a power source indicated on the product's electrical ratings label. If you have questions about the type of power source to use, contact your authorized Miltenyi Biotec service provider or local power company. Do not use extension cords or power strips. Do not overload an electrical outlet. The overall system load must not exceed 80% of the branch circuit rating. Make sure that the main switch and the connector of the power cable are easily accessible and located as close to the operator of the instrument as possible. If it is necessary to disconnect the power supply, unplug the cable from the power outlet.

### 3.1 Switching on the instrument

#### 3.1.1 When switching on the instrument for the first time

**WARNING!** Before operating the autoMACS Pro Instrument for the first time, carefully read the user manual and contact your local Miltenyi Biotec representative for assistance. Always wear protective gloves and eyewear in order to protect against potential biohazard exposure.

When delivered, the pump syringe is not installed. The autoMACS Pro fluidic system is filled with double-distilled water and the column slots contain column substitutes. Before operation, install the pump syringe first, then remove the column substitutes and install the autoMACS Columns. Rinse the fluidic system before first usage.

The autoMACS user interface is composed of five main menus: **Reagent**, **Separation**, **Status**, **Log list** and **Option**. They are accessed through the upper tabbed menu bar (see figure 4.1). Six buttons at the bottom of the screen allow for easy interaction with the instrument. The function of the buttons may vary depending on which main menu is chosen (see figure 4.3). Also, depending on the menu and the instrument's status, not all buttons are available at all times. If a button is unavailable, its background color changes from white to grey.

After initialization, the screen automatically displays the **Status** menu, which helps to monitor the instrument during installation and operation. For more information about the autoMACS user interface, please refer to section 4.

- 1 Note the position of the power socket on the rear panel of the autoMACS Pro Separator (see figure 1.2).
- 2 Ensure that the main power switch is in position **O** (off).
- 3 Connect the power cord.
- 4 Switch on the autoMACS Pro Separator. As the instrument still contains the column substitutes at this point, a pop-up window will inform the user that the columns are not installed. Select **Ignore**.



**Figure 3.1:** A warning screen informs the user that no columns are installed.

### 3.1.1.1 Installing the pump syringe

- 1 Open the front door of the autoMACS Pro Separator.
- 2 Pull out the plunger of the pump syringe and humidify it with distilled water. Push it halfway into the glass pipe.



**Figure 3.2:** Humidify the plunger.

- 3 Remove the blind screw and the protective tape. Fasten the syringe at the dilutor valve by turning the top screw clockwise until a resistance is met (see section 7.2.3 for a detailed description on how to clean and install the pump syringe). Unfasten the top screw again by one rotation.



**Figure 3.3:** Fasten the syringe at the dilutor valve.

- 4 Pull the plunger out of the syringe until it reaches its fitting in the plunger holder. In order to fit, the plunger must have the same orientation as the fitting (see figure 7.2 – 7.6). Tighten the plunger lock screw.

- 5 Tighten the syringe at the diluter valve by turning the top screw until a resistance is met.
- 6 Switch on the instrument. The plunger holder will move up again.

### 3.1.1.2 Installing autoMACS Columns

- 1 Note the position of the tubing and autoMACS Column slots in the magnet cover (column 1 to the left, column 2 to the right, see figure 1.1).
- 2 Ensure that the fluid bottles are filled with the appropriate solutions.
- 3 Go to **Option > Special**. Refer to section 4 for details on how to work with the user interface.
- 4 Select **Col\_ex** (column exchange) from the **Detail** panel.
- 5 Select **Run** to start the **Col\_ex** program.
- 6 Wait until the instrument prompts you to exchange the autoMACS Columns.
- 7 Using both hands, take the top and bottom of column 1 substitute and pull gently but firmly to remove it from its slot.



**Figure 3.4:** Column exchange.

- 8 Place a wide-mouth bottle under the column substitute to catch any fluids.
- 9 Hold the column substitute in one hand and gently unscrew the bottom column connector counter-clockwise. Unscrew the top column connector clockwise (see figure 3.5). Store the column substitutes for later usage. **Note:** Replace columns with column substitutes if the instrument is shut down for a longer period of time. See section 3.2.2 for details.

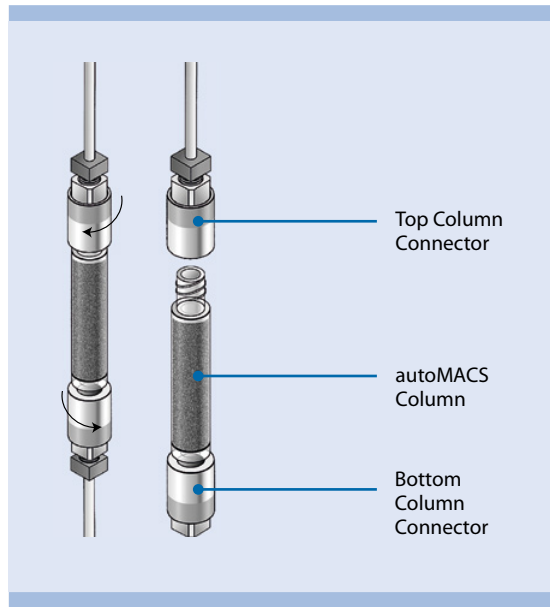

**Figure 3.5:** Exchange of autoMACS columns.

- 10 Insert one end of a fresh column into the bottom column connector and gently screw in the column by turning it clockwise until you feel a resistance. Point the column towards the top of the instrument and screw in the top column connector.
- 11 Align the column with the top column connector sitting on the guiding of the magnet cover. Press the column into the slot until you feel the guides click. Verify that the column is placed in the center of the magnet cover.
- 12 Remove column 2 from its slot and repeat steps 8 through 11.
- 13 Ensure that the tubing is neither pinched nor obstructed.
- 14 Press **Done**. The program will then proceed to wash the columns with autoMACS Running Buffer. Check that the columns are securely fastened to the column connectors and that no buffer is leaking.
- 15 Close the front door. **Note:** The instrument automatically records the date of the column exchange if the program **Col\_ex** has been used for column installation, and can display the due date for the next column exchange.
- 16 Prime the autoMACS Pro Separator as described in section 3.1.3.
- 17 Run the program **Calibr\_2** to calibrate the fluidic volume control of the instrument. Refer to section 5 for details.



### 3.1.1.3 Set the date and time

When switching on the autoMACS Pro Separator for the first time, the user is prompted to set the correct time and date. **Note:** Set the correct date and time to properly schedule maintenance procedures such as column exchanges.

- 1 Go to **Option > User settings > Set\_time**. Press **Run**.
- 2 Select the time or date fields by touching the respective fields on the display.
- 3 Use the keypad to change the date or time.

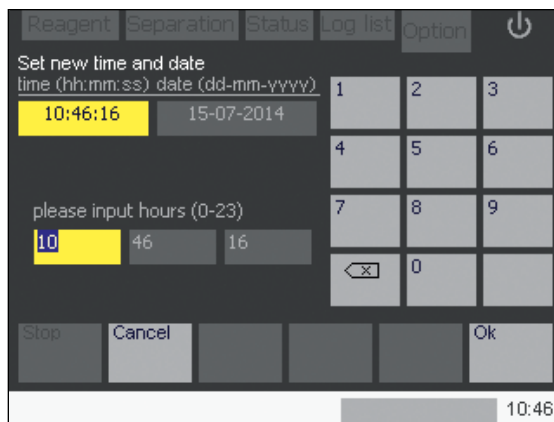

**Figure 3.6:** Select the desired field and use the numeric keypad to modify the date and/or time.

- 4 Press **Ok** to return to the **Option** menu. The procedure can be cancelled at anytime by pressing **Cancel**.

### 3.1.1.4 Testing the bar code scanner

**CAUTION!** Do not look directly at the light emitted by the 2D code reader. Eye injury may result. Do not activate the 2D code reader if the washing station cover is open.

- 1 Go to **Reagent > Read Reagent**.
- 2 Place a barcode, e.g. the test bar code below, in front of the 2D code reader. Refer also to section 4.2. The name of the scanned reagent will appear in the display, in this case "CD4 Microbeads, human (#130-045-101)".



**Figure 3.7:** Test barcode.

### 3.1.1.5 Test the needle calibration

Correct needle calibration is necessary for proper sample and reagent uptake. Before using the autoMACS Pro Separator for the first time, check whether the uptake and output needle are positioned correctly when moving into in the washing station, sample tubes and reagent vials (uptake needle only). Test needle calibration also if the instrument was moved to a different place. Please refer to section 5 for details.

### 3.1.2 Checking fluid levels

The closures for the fluid bottles are equipped with a sensor to measure electrolyte conductivity. A pop-up window will warn the user if the bottles do not carry enough buffer for at least one separation, or if the waste bottle is full. However, the exact filling status cannot be determined. Thus, if more than one separation is to be performed, check the filling status of all bottles visually.

It is recommended to monitor the bottle status when the autoMACS Pro Separator is in operation. To do so, go to the **Status** menu from the upper navigation bar. On the left hand side of the menu, four symbols display the solution bottles and their filling status. If the fluid bottles are full and the waste bottle is empty, the respective symbols are green. If the solution bottles are empty or the waste bottle is full, the respective symbols are red. Note that the symbol for the storage solution bottle always remains gray, as its filling status cannot be determined by the instrument.

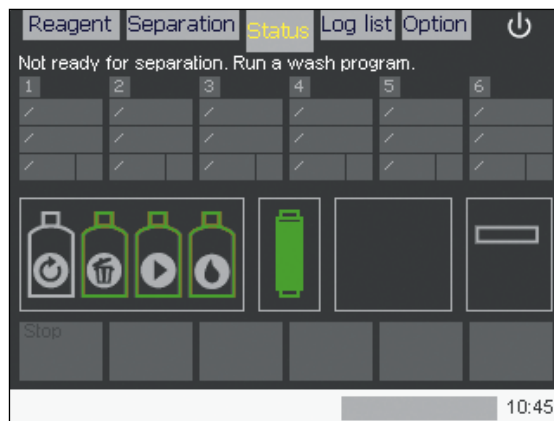
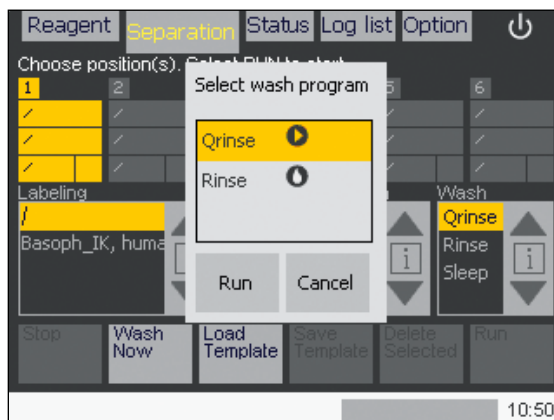

**Figure 3.8:** Status of fluid levels.

### 3.1.3 Priming

Priming implicates the initial cleaning and filling of the autoMACS Pro Separator fluidic system before cell separations are performed. The autoMACS Pro Separator must be primed each time the instrument is switched on. If no wash program has been performed before the first separation, a pop-up window will remind the user to rinse the system.

- 1 Ensure that all bottles are filled with the appropriate solutions and that the waste bottle is empty.
- 2 Switch on the autoMACS Pro Separator and wait for the instrument to complete initialization.
- 3 After initialization is completed, the **Status** menu will be displayed. For more details on the Status menu, please refer to section 4.1.
- 4 Verify that the touchscreen symbols for all fluid bottles are green (except for the grey symbol for the storage solution bottle).
- 5 Ensure that the symbol for the columns is green. If the symbol is red, exchange the columns. The fill level on the symbol is an indicator for the remaining operation life of the columns.
- 6 Ensure that the MACS MiniSampler Plus is installed correctly. For more details concerning correct installation of the MACS MiniSampler Plus refer to section 2.6.
- 7 The autoMACS Pro Separator is now ready for priming. Go to the **Separation** menu and press the **Wash Now** button at the bottom of the screen.



**Figure 3.9:** Select **Rinse** to prime the autoMACS Pro Separator.

- 8 Select **Rinse** and press **Run** to start the priming process.
- 9 When priming is finished, the instrument will display **Ready for separation** in the **Status** menu. **Note:** When priming the instrument for the first time it is recommended to inspect the fluidic system for potential leaks. Open the

front door after priming the instrument. If there is any sign of leakage (e.g. salt deposits), tighten the tubing connections. Close the front door.

## 3.2 Shutting down the instrument

### 3.2.1 Sleep modus

Make sure to run the **Sleep** program before switching off the instrument. If the device is inactive for more than six hours, the autoMACS Pro Separator automatically performs the **Sleep** program. To prevent the formation of salt deposits, wipe the outlet ports with a tissue soaked with distilled (or deionized) water before running the **Sleep** program. For convenience, you can also choose **Sleep** instead of a wash program after your last separation. See section 6.4 and 6.11 for details.

- 1 Press the shutdown button at the upper right hand corner of the screen (see figure 3.9).
- 2 Select **Yes** from the pop-up dialog window.
- 3 Upon completion of the **Sleep** program, you will be prompted to shut down the instrument. Switch off the autoMACS Pro Separator using the main power switch.

### 3.2.2 Long-term storage

If the autoMACS Pro Separator will not be used for more than two weeks, clean the fluidic system and replace the columns with column substitutes. The **Store** program automatically performs the cleaning procedure and prompts the user to install column substitutes. Column substitutes are installed the same way as regular separation columns.

- 1 Go to **Option > Special**.
- 2 Select **Store** and press **Run**. The system will be rinsed automatically.
- 3 Install the column substitutes as described in section 7.2.1.
- 4 Press **Done**.
- 5 Switch off the autoMACS Pro Separator using the main power switch.



# 4

## The autoMACS<sup>®</sup> Pro user interface

The autoMACS Pro user interface is composed of five main menus: **Reagent**, **Separation**, **Status**, **Log list** and **Option**. They are accessed through the upper tabbed menu bar (see figure 4.1). Six buttons at the bottom of the screen allow for easy interaction with the instrument. The function of the buttons may vary depending on which main menu is chosen (see figure 4.3). Also, depending on the menu and the instrument's status, not all buttons are available at all times. If a button is unavailable, its background color changes from white to grey.

Menu	Function
Reagent	To define the position of MACS Reagents on the MACS Reagent Rack 4.
Separation	To define an autolabeling and/or cell separation strategy for up to six samples. In addition, cell processing procedures can be saved as templates for regular use.
Status	Displays the current instrument's status.
Log list	The log list details completed actions and errors.
Option	Allows for special procedures, such as MACS Columns exchange, instrument calibration, and service steps.

**Table 4.1:** Menu options.

## 4.1 The Status menu

The autoMACS Pro Separator is a sensor-controlled instrument that allows easy monitoring during operation. After initialization, the screen automatically displays the **Status** menu, which helps to monitor the instrument. It displays the current instrument status and can be accessed at any time (see figure 4.1).

Color-coded symbols indicate the status of the hardware components. For further information on a particular component, touch the symbol. A pop-up window will open and detail more information. To close the pop-up window, touch the black circle in the upper right corner of the window (see figure 4.2).

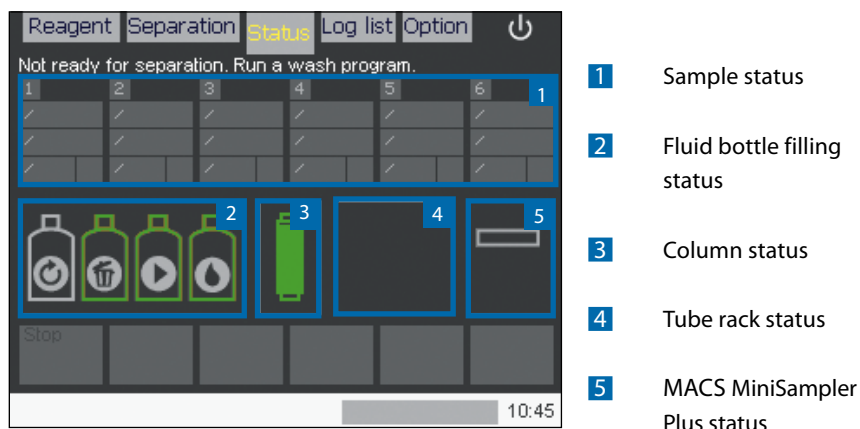

**Figure 4.1:** The status menu.

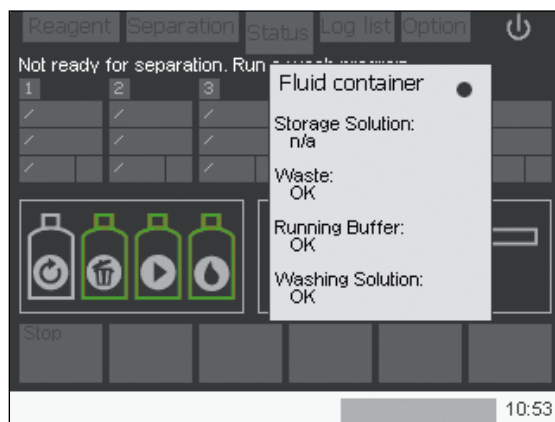

**Figure 4.2:** Touch any symbol to display the current status, e.g. Fluid bottle filling status.

### 4.1.1 Sample status

The background color of the sample fields (1) indicates the sample status. Programs yet to be processed appear in yellow fields. Programs currently undergoing autolabeling appear in purple. Programs in progress in which no autolabeling is being performed switch to orange; completed programs switch to white. Refer to section 6.8 for details. The current action is displayed in the status bar located below the lower navigation bar. The status bar also displays the overall progress in minutes.

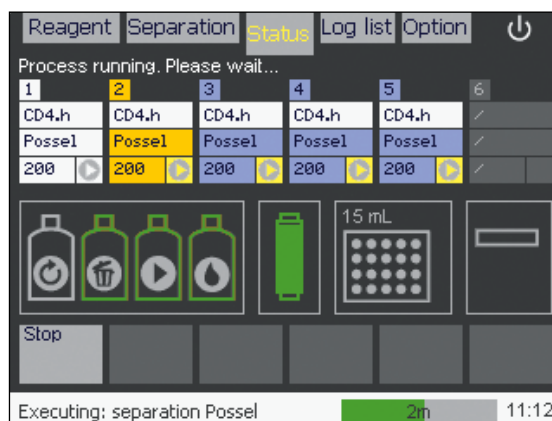

**Figure 4.3:** Sample status during separation.



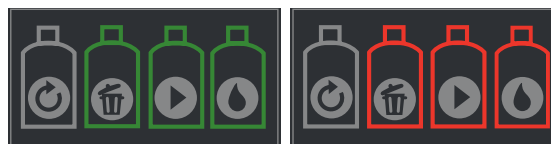

### 4.1.2 Fluid bottle status

The status of fluid bottles (2) is indicated by color-coded graphic symbols. If the fluid bottles are full and the waste bottle is empty, the symbols are green. If the solution bottles are empty or the waste bottle is full, the respective symbols are red. If the sensor cables are connected to a wrong bottle closure, the symbols are also displayed in red. Note that the symbol for the storage solution bottle remains gray, as its filling status cannot be determined. Touch any fluid bottle symbol to open a pop-up window for further information.



**Figure 4.4:** Fluid bottle status. Left: No action required. Right: Check fluid bottles for possible problems.



Bottle	Symbol	User action
Running buffer		Green: no action required Red: refill bottle Grey: connect bottle sensor
Washing Solution		Green: no action required Red: refill bottle Grey: connect bottle sensor
Storage Solution		Gray: No liquid detection possible, check visually
Waste		Green: no action required Red: refill bottle, Grey: connect bottle sensor

**Table 4.2** Fluid bottle status.

### 4.1.3 Column status

If the column symbol (3) is green, no action is required. If the symbol is red, the columns must be exchanged (refer to section 7.2.1 for details on column exchange). The level of the green fill on the column symbol indicates the remaining operation-life of the autoMACS Columns. Touch the column symbol to open a pop-up window for further information.

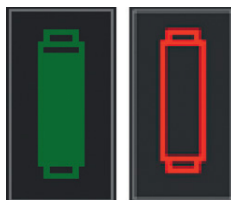

**Figure 4.5:** Column status. Left: No action required. Right: Column exchange is necessary.

### 4.1.4 Tube rack status

Tube rack detection occurs prior to the separation process. The instrument will not attempt to detect the rack before cell labeling and/or cell separation is performed. If no graphic is displayed, no tube rack was detected (4). If tube rack recognition fails, a dialog box will open and ask for manual selection of the correct tube rack. Touch the tube rack status window to open a pop-up window for further information.



**Figure 4.6:** Tube rack status graphic: Chill 5 Rack was detected.

### 4.1.5 MACS MiniSampler Plus status

If the MACS MiniSampler Plus has been detected correctly, a rectangular symbol is displayed (5). If it has not been detected, a hand symbol will be displayed in the same field.

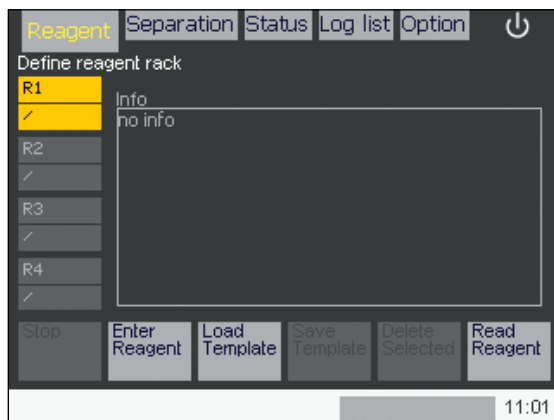

**Figure 4.7:** MACS MiniSampler Plus status graphic. Left: The MACS MiniSampler Plus was successfully installed. Right: No MACS MiniSampler Plus was detected.

## 4.2 The Reagent menu

The **Reagent** menu is used to assign reagent vials to one of the four reagent rack slots (**R1**, **R2**, **R3**, and **R4**) to perform automated magnetic labeling. Enter reagents manually or use the 2D code reader. The panel on the left side of the screen represents the reagent rack. Highlight a rack position by touching the corresponding position on the display. Touch it once again to deselect a position.

**CAUTION!** Do not look directly at the light emitted by the 2D code reader. Eye injury may result. Do not activate the 2D code reader if the washing station cover is open.



**Figure 4.8:** The **Reagent** menu.

### 4.2.1 Entry of reagents with the 2D code reader

- 1 Go to the **Reagent** menu. Highlight the reagent rack position where the vial will be placed in the reagent rack.
- 2 Press the **Read Reagent** button to activate the 2D code reader and present a reagent vial in front of the 2D code reader. Ensure that the 2D code is facing the blinking light. The optimal reading distance is 0.5–2.5 cm from the code reader, tilt the vial as depicted.



**Figure 4.9:** Scanning a reagent using the 2D code reader.

- 3 The reagent is automatically recognized and assigned to the currently highlighted reagent rack position. The next reagent rack position will be highlighted automatically. **Note:** If the 2D code reader cannot identify the reagent, please enter the reagent information manually (see below).

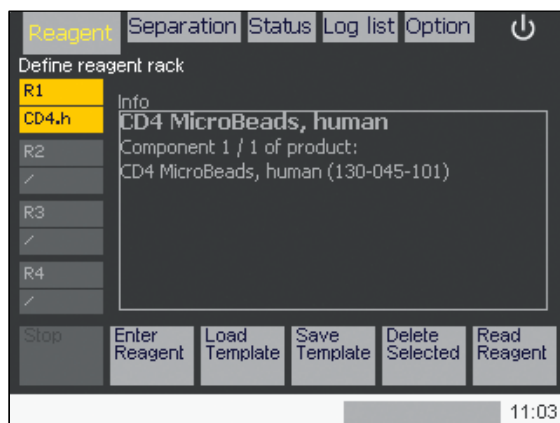

**Figure 4.10:** Successfully scanned reagents appear on the screen.

- Using the same procedure, up to four reagent vials can be scanned and assigned using the 2D code reader. Combinations of four reagents can be saved as a template for later use by pressing the **Save Template** button. Refer to section 6.10.3 for details on how to use templates.
- After all desired reagents are entered, open the MicroBead reagent vials and place them on the MACS Reagent Rack 4 in the correct order.
- Go to the **Separation** menu to proceed with programming a cell separation procedure (see section 4.3 for details).

### 4.2.2 Manual entry of reagents

- Go to the **Reagent** menu and highlight the position where the vial will be placed on the reagent rack.
- Select **Enter Reagent** from the lower navigation bar. Enter the reagent-specific product order number. Press **Ok**.



**Figure 4.11:** Reagent information is entered manually.

- 3 If a correct number is inserted, the software will recognize the reagent or kit. Select the reagent from the list by using the touch screen.
- 4 Press **Ok** to confirm the identified reagent and its reagent vial position.

### 4.2.3 Deleting reagents

#### 4.2.3.1 Deleting a single reagent from the reagent list

- 1 Highlight the reagent name that is to be deleted.
- 2 Press **Delete Selected** to remove the highlighted reagent.

#### 4.2.3.2 Deleting the entire reagent list

- 1 Highlight an unassigned position on the reagent rack. If there are no unassigned positions, delete an individual reagent as described above.
- 2 Press **Delete All**.

## 4.3 The Separation menu

The **Separation** menu schematically represents a sample rack. For each sample rack position, it is possible to define cell labeling, cell separation, and washing programs. Program combinations can be saved as a template for later use by pressing the **Save Template** button. Refer to section 6.10.3 for details on how to use templates. It is also possible to perform a single wash program prior to separation by pressing the **Wash now** button at the bottom of the screen.

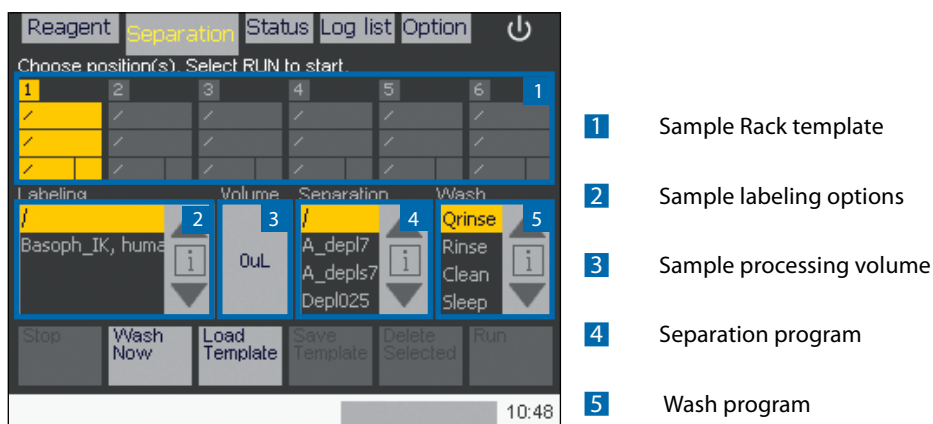

**Figure 4.12:** The **Separation** menu.

### 4.3.1 Sample rack template

The positions in the sample rack template field (1) correspond to the sample positions in the tube rack. Positions 1–6 are used in combination with Chill 5 Rack, positions 1–5 with Chill 15 Rack, and positions 1–3 with Chill 50 Rack. See section 6.7 for details on the different tube rack and loading positions. Highlight a sample position by touching the corresponding position on the display.

### 4.3.2 Sample labeling options

The **Labeling** submenu (2) is used to instruct the instrument if autolabeling is to be performed on a sample, and what type of autolabeling will be performed. By default, no autolabeling will be performed (7). A list of product options is visible if reagents have already been assigned to positions on the reagent rack using the **Reagent** menu.

#### 4.3.2.1 Assign a labeling option to a single sample

- 1 Highlight a sample using the sample rack template.
- 2 Scroll through the **Labeling** submenu using the arrows.
- 3 Select the desired **Labeling** reagent.

#### 4.3.2.2 Assign one labeling option to several samples

- 1 Highlight several samples using the sample rack template.
- 2 Scroll through the **Labeling** submenu using the arrows.
- 3 Select the desired **Labeling** reagent.

#### 4.3.2.3 Apply an assigned labeling option to other samples

- 1 Assign a program to the first sample (refer to above).
- 2 Select subsequent samples: The same program will be automatically applied to the selected samples.

### 4.3.3 Assigning sample volumes

The **Volume** submenu (3) is used to enter or modify sample volumes. It is mandatory to assign a volume for autolabeling. For manually labeled samples, it is not mandatory to assign a volume. However, the autoMACS Pro Separator requires this information to calculate and display the total sample processing time. Volumes are given in microliter ( $\mu\text{L}$ ).

- 1 Highlight one or more sample(s) using the sample rack template.
- 2 Touch the **Volume** submenu: A dialog box will appear.
- 3 Using the numeric keypad enter the sample volume. For autolabeling enter the sample volume for the first labeling step as outlined in the corresponding data sheet (e.g. 160  $\mu\text{L}$  /  $2 \times 10^7$  cells for labeling with CD4 MicroBeads, human or 120  $\mu\text{L}$  /  $4 \times 10^7$  cells for labeling with the Monocyte Isolation Kit II, human).  
**Note:** The minimal incubation volume after the addition of the first reagents may not be less than 200  $\mu\text{L}$ .
- 4 Press **Enter**.

#### 4.3.4 Assigning a cell separation program

The **Separation** submenu (4) is used to instruct the autoMACS Pro Separator which cell separation program should be applied to each sample. Several sample positions can be highlighted to assign one separation program to multiple samples. Refer to section 6.2 and 6.3 for a detailed explanation of the various cell separation strategies.

- 1 Highlight one or more sample(s) using the sample rack template.
- 2 Scroll through the **Separation** submenu using the arrows.
- 3 Select a **Separation** program.

#### 4.3.5 Assigning a wash program

The **Wash** submenu (5) is used to instruct the autoMACS Pro Separator, which wash program should be applied to each sample after separation. Four wash programs are available to choose from: **Qrinse**, **Rinse**, **Sleep** and **Clean**. Refer to section 6.4 for a detailed explanation of the respective programs.

- 1 Highlight one or more sample(s) using the sample rack template.
- 2 Scroll through the **Wash** submenu using the arrows.
- 3 Select the desired **Wash** program.

#### 4.3.6 Delete program combinations

To erase selected program combinations from the programming field, first highlight the respective positions and choose **Delete selected** from the lower navigation bar. If positions are not highlighted, the button can be used to delete the entire template. In this case, the button **Delete selected** will switch to **Delete all**.

## 4.4 The Log list menu

The **Log list** menu displays a complete log of actions performed by the autoMACS Pro Separator. Completed processes are marked with a green checkmark. If a process is listed in red and is marked by an **X**, the process was either aborted or some problem occurred. See section 9.3 for details.

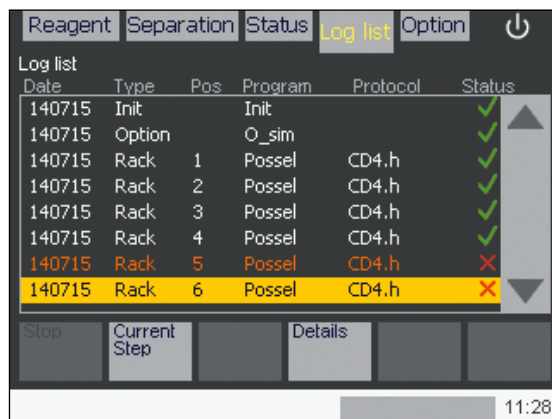

Figure 4.13: The Log list menu.

- 1 Go to **Log list** and highlight a log from the log list.
- 2 Press **Details**. A detailed view of the program status is shown.
- 3 Press **Ok** to return to the log list screen or press **Log Details** to view an even more detailed log of performed actions. Press **Current step** to display the log of the last step performed.

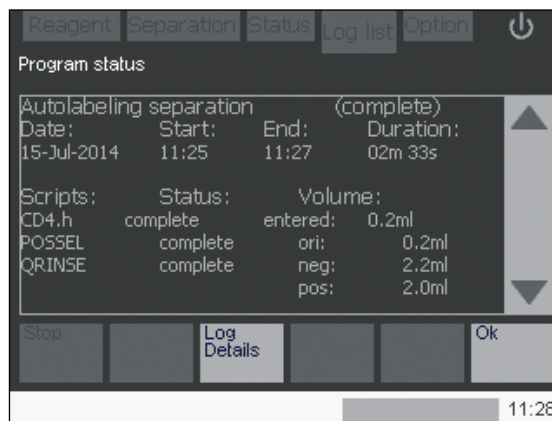
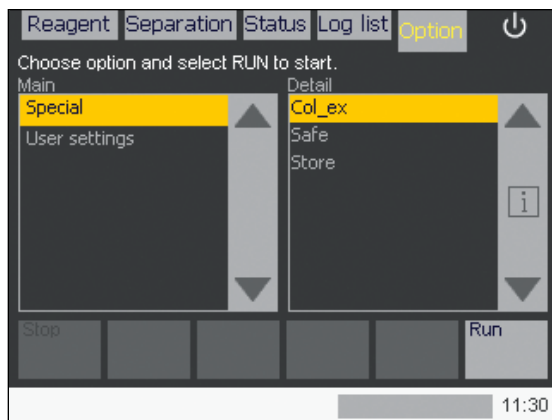

Figure 4.14: The Log list menu: Details



## 4.5 The Option menu

The **Option** menu allows maintenance procedures, such as exchange of autoMACS Columns or disinfection of the system. The menu is divided into two main categories, **Special** and **User settings**.



**Figure 4.15:** The **Option** menu.

### 4.5.1 Special

**Special** comprises three commonly used programs: column exchange (**Col\_ex**), instrument decontamination (**Safe**), and cleaning of the instrument for long-term storage (**Store**).

**Col\_ex** – Column exchange program

Applied when installing or exchanging autoMACS Columns.

**Safe** – disinfectant program

The Safe program is to be used with a bleach solution (1% sodium hypochlorite) for cleaning and disinfection of the autoMACS Pro Separator. Depending on the level of instrument use, it is recommended to run the **Safe** program at least every 3 to 6 months. If material like whole blood or tissue is primarily used, it is recommended to run the **Safe** program once a month.

**Store** – prepares the instrument for long-term storage

To store the autoMACS Pro Separator for a period longer than two weeks, the tubing system should be cleaned and the columns should be replaced with column substitutes. The **Store** program automatically performs the cleaning procedure and prompts the user to install column substitutes. Upon completion of the **Store** program, the fluidic system contains 70% ethanol.

## 4.5.2 User settings

**User settings** contain programs necessary for maintenance and setup of the autoMACS Pro Separator.

### **About** – System and hardware information

This program informs the user about the software version, serial number of the instrument, and other hardware information.

### **Calibr\_1** – Calibrating the needle arm position

This program is used for the calibration of the needle arm to the washing station and tube racks. Refer to section 5 for more information.

### **Calibr\_2** – Calibrating the liquid volume control

This program is used for the calibration of the liquid volume control. Refer to section 5 for more information.

### **Check\_up** – Performing a system check-up

The **Check\_up** program allows the user to perform a system check-up. It is recommended to use the program if hardware errors occur. Refer to section 9.1 for details.

### **O\_bcr** – 2D code reader setup, configuration, and initialization

The **O\_bcr** program allows the user to setup, configure, and initialize the autoMACS Pro Separator 2D code reader.

### **O\_init** – Optional priming of the instrument at startup

By default, the autoMACS Pro Separator does not perform a wash program after initialization. The option **O\_init** allows the user to add an initial rinse program to automatically prime the instrument after initialization.

### **O\_led** – Activate/deactivate fluid bottle illumination

The autoMACS Pro Separator has a bottle illumination designed to facilitate monitoring the instrument's status. The bottle illumination can be switched on or off.

**O\_progs** – Enabling/disabling special separation protocols

The **O\_progs** are used to enable or disable special separation programs.

- 1 Go to **Option > User settings > O\_progs**.
- 2 Press **Run**. A dialog box will report the current status.
- 3 Press **OK** if the current reported status should not be changed. Alternatively, select **Disable** (or **Enable**) to change the status.

**Sepcount** – Displaying the number of performed separations

The **Sepcount** program is used to display the number of separations that have been performed on the autoMACS Pro Separator.

- 1 Go to **Option > User settings > Sepcount**.
- 2 Press **Run**. A dialog box will report the number of separations.
- 3 Press **OK** to return to the **Option** menu.

**Set\_time** – Setting the time and date

To set time and date, refer to section 3.1.1.

**Syrin\_ex** – Installing or cleaning the syringe pump

This program is used during instrument maintenance. Refer to section 7.2.3 for details.

**Valve\_ex** – Exchanging the instrument valves

This program is used for valve exchange. Use of this program turns the valve to the exchange position for removal. Refer to section 7.3.1 for details.

# 5

## Calibration



### WARNING

Read the instructions in the chapter **Important safety information** before operation of the instrument.

The autoMACS Pro Separator is calibrated using two programs, **Calibr\_1** and **Calibr\_2**. **Calibr\_1** is used to calibrate the settings of the needle arm (x-, y-, and z-axis). Calibrating the needle arm is recommended after instrument or software installation or after moving the instrument to a different location. If the MACS MiniSampler Plus or one of the needles was exchanged, needle calibration should also be checked.

**Calibr\_2** automatically calibrates the liquid volume control. This is crucial for correct measurement and processing of the sample volumes. Run the **Rinse** program before running **Calibr\_2** to fill the fluidic system with buffer. Always run **Calibr\_2** after the pump syringe, any of the valves or the tubing was exchanged.

### 5.1 Calibrate the needle position

#### 5.1.1 Running a test calibration

Check proper needle calibration by running a test calibration. Open the washing station cover and remove the MACS MiniSampler Plus cover for better visibility.

- 1 Go to **Option > User settings > Calibr\_1**. Press **Run** and then **Test**.

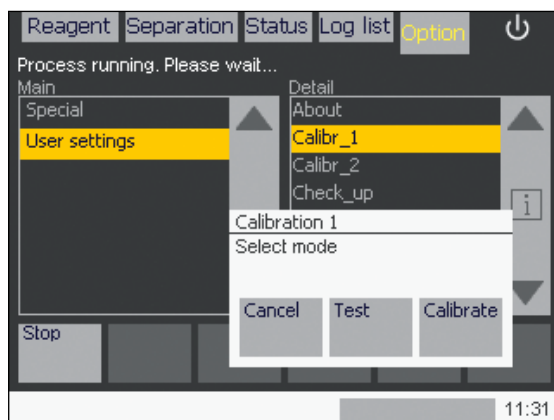

**Figure 5.1:** Calibration 1 modes.

- 2 When prompted, place a Chill 15 Rack onto the MACS MiniSampler Plus. Place 15 mL conical centrifugation tubes in positions **A1**, **B1** and **C1** and confirm by pressing **Done**.
- 3 When prompted, place the MACS Reagent Rack 4 containing four sample vials onto the MACS MiniSampler Plus. Confirm by pressing **Done**.
- 4 A pop-up window will appear: **Test position: washing station**. Select **Test position**. The instrument will automatically place the needle in the washing station. Ensure that the needle is centered above the rear opening of the washing station. To skip this position, select **Next**. To end testing, select **Test end**.

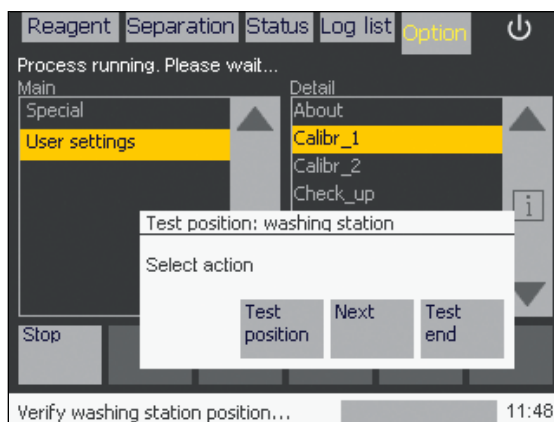
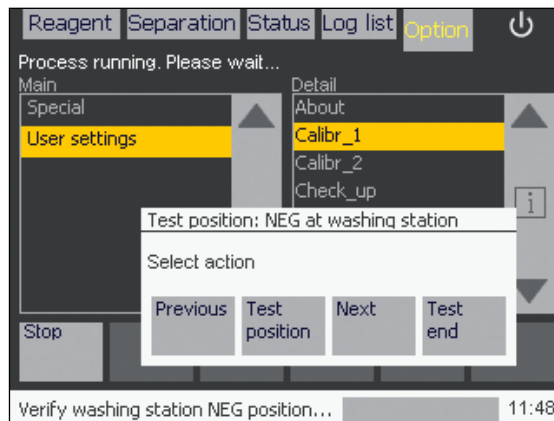

**Figure 5.2:** Running a test calibration.



**Figure 5.3:** Uptake needle position in the washing station (arrow).

- 5 When done with testing the current position, press **Done**. The next position (NEG needle) will be addressed automatically.

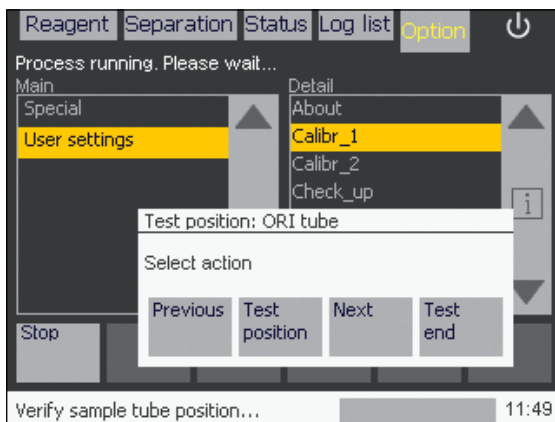

**Figure 5.4:** Test position: NEG needle in the washing station.



**Figure 5.5:** NEG needle in the washing station.

- 6 Ensure that the NEG needle is centered above the front opening of the washing station.
- 7 In the following, the needle position can be tested for tube rack position **A1 (ORI)**, **B1 (NEG)** and **C1 (POS)** as well as **Reagent Rack positions 1-4**. To check the exact needle position, use the **Move up** and **Move down** buttons to raise or lower the uptake needle, respectively. Ensure that the uptake needle is positioned directly above the center of the tube. Lower the needle all the way to the bottom of the tube to check that the needle is centered. For the Reagent Rack, the needle should be located at the lowest point of the vial to ensure full reagent uptake.



**Figure 5.6:** Test position: ORI tube.



**Figure 5.7:** Test position: Uptake needle position in the Chill Rack.

- 8 After testing the last position, press **Done**. Press **Done** once again to leave test calibration, and press **Cancel** to close the calibration program.

### 5.1.1.1 Calibrating the needle position

If the needles are not positioned correctly in the washing station and/or the sample tubes, run a **Calibr\_1**. Open the washing station cover and remove the MACS MiniSampler Plus cover for better visibility.

- 1 Go to **Option > User settings > Calibr\_1**.
- 2 Press **Run** and then **Calibrate**. The first of five (1/5) calibration steps will begin, namely, the needle position in the washing station.

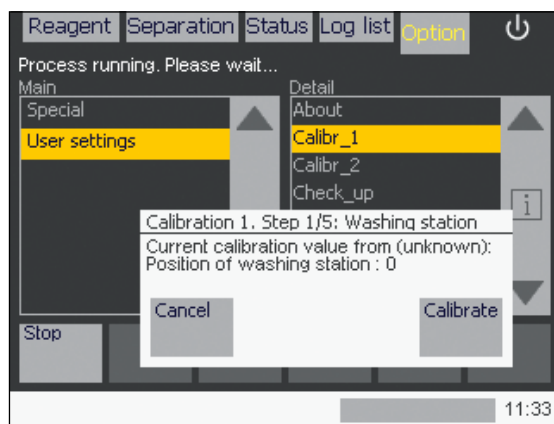

**Figure 5.8:** Calibration 1 Step 1/5: check needle position in the washing station.

### 5.1.1.2 Calibrate the washing station: Uptake needle (step 1/5)

- 1 Chose current position to start with (recommended, press **Use**). The needle arm will automatically move towards the washing station. The uptake needle should be located directly above the center of the **rear opening** of the washing station (see figure 5.3).

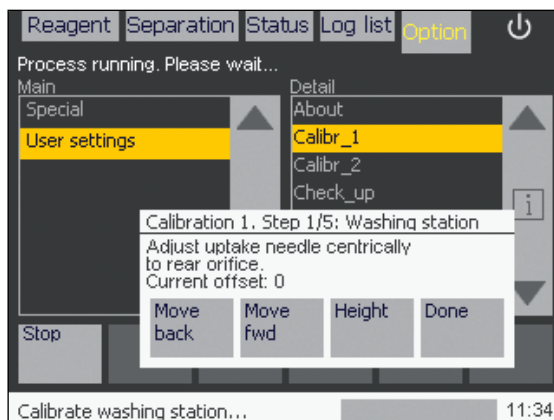

**Figure 5.9:** Calibrate the uptake needle position in the washing station.



- 2 Press **Height**. Check the central positioning of the uptake needle by using the buttons **Move up** and **Move down**.
- 3 Select **Position** and adjust by using the **Move back** and **Move fwd** buttons. Select **Done** after making necessary adjustments.

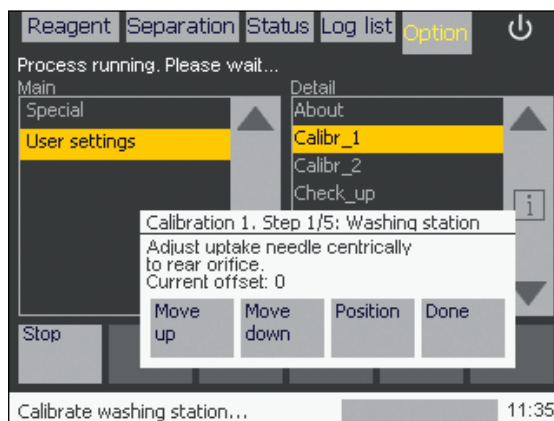
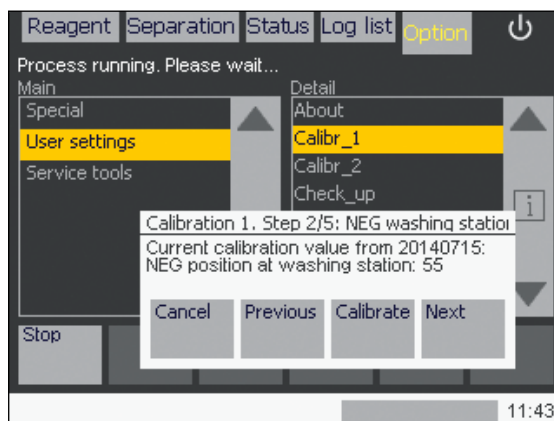

**Figure 5.10:** Calibrate the uptake needle position in the washing station.

- 4 Select **Save** to save the new configuration.

### 5.1.1.3 Calibrate the washing station: NEG needle (step 2/5)

- 1 Select **Calibrate** to proceed with calibration.



**Figure 5.11:** Calibration 1 Step 2/5: check NEG needle position in the washing station.

- 2 Chose either current position to start with (recommended, press **Use**) or reset needle position to factory settings (press **Reset**). The needle arm will automatically move towards the washing station. The needle should be located directly above the center of the **front opening** of the washing station (see figure 5.5).

- 3 Select **Height** and check the central positioning of the needle by using the buttons **Move up** and **Move down**. Select **Position** and adjust by using the **Move back** and **Move fwd** buttons. Select Done after making necessary adjustments.
- 4 Select **Save** to save the new configuration.

#### 5.1.1.4 Calibration of the z-axis (step 3/5)

- 1 Select **Calibrate** to proceed with calibration.

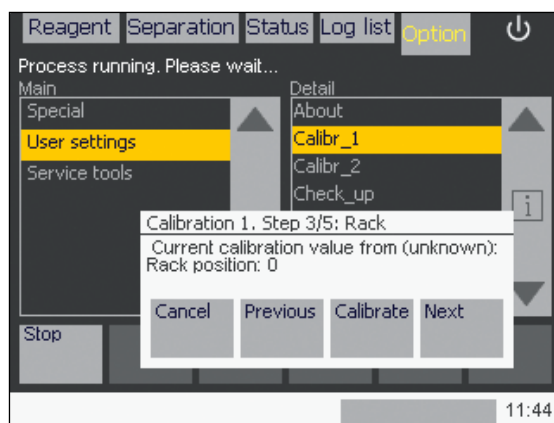
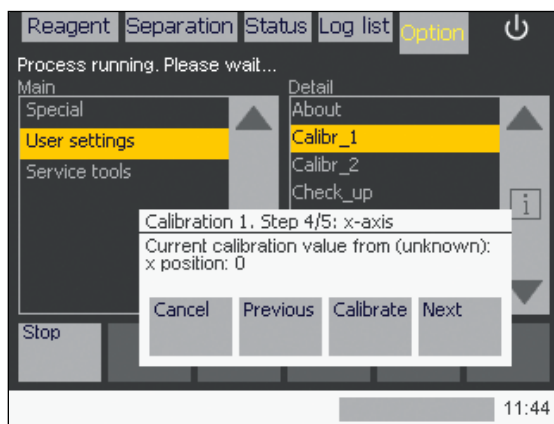

**Figure 5.12:** Calibration 1 Step 3/5: check needle position above the chill rack.

- 2 If you haven't done so yet, place a Chill 15 Rack onto the MACS MiniSampler Plus. Place three 15 mL conical centrifugation tubes in positions **A1**, **B1** and **C1**. Confirm by pressing **Done**. The needle arm will move to rack position **A1**.
- 3 Press **Height** and check the positioning of the uptake needle at the bottom of the tube. To do so, press **Down** until the needle hits the bottom and the **Down** button disappears. Go up again by one increment. The needle should be centered.
- 4 If the needle tip is **not** located directly in the middle of the conical tube, press **Position**. Use the needle navigation buttons (**Move back**, **Move fwd**) to correct the needle position. Press **Done** to continue with calibration.
- 5 Press **Save** to store the new settings.

### 5.1.1.5 Calibration of the x-axis (step 4/5)

- 1 Press **Calibrate** to proceed with calibration.

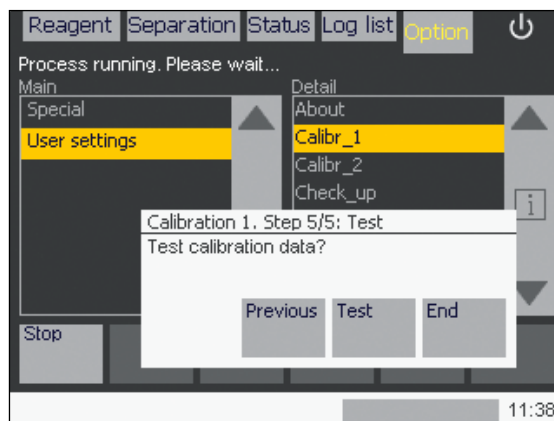

**Figure 5.13:** Calibration 1 Step 4/5: Calibration of the x-axis.

- 2 If you haven't done so yet, place a Chill 15 Rack onto the MACS MiniSampler Plus. Place three 5 mL conical centrifugation tubes in positions **A1**, **B1** and **C1**. Press **Done** to confirm. The needle arm will move to position **A1** of the tube rack.
- 3 Select **Use** to start the calibration at current position (recommended). Press **Reset** to use factory settings.
- 4 Press **Height** and check the positioning of the uptake needle at the bottom of the tube. To do so, press **Down** until the needle hits the bottom and the **Down** button disappears. Go up again by one increment. The needle should be centered.
- 5 If the needle tip is **not** located directly in the middle of the tube, press **Position**. Use the needle navigation buttons (**Move left**, **Move right**) to correct the needle position. Press **Done** to continue with calibration.
- 6 Press **Save** to store new settings.

### 5.1.1.6 Test current calibration settings (step 5/5)

- 1 Press **Test** to check the new configuration. The autoMACS Pro Separator will perform a complete test of **Calibr\_1** settings.



**Figure 5.14:** Calibration 1 Step 5/5: Test calibration.

- 2 If you haven't done so yet, place a Chill 15 Rack onto the MACS MiniSampler Plus. Place 5 mL conical centrifugation tubes in positions **A1**, **B1** and **C1**. Press **Done** to confirm.
- 3 If you haven't done so yet, place the MACS Reagent Rack 4 containing 4 sample vials onto the MACS MiniSampler Plus. Press **Done** to confirm.

In the next steps, you can test the calibration settings of the washing station, the tube rack position **A1**, **B1**, and **C1**, the x-position, and vials 1–4 in the Reagent Rack. To test a position select **Test position**. To skip a position select **Next**. Check all approached positions by using the needle navigation buttons **Move up** and **Move down**, then press **Done**. After testing the last position the **Calibr\_1** screen will reappear. Select **Cancel** to leave the calibration program. If any errors or misalignments were noted, repeat the entire process.

## 5.2 Calibrating the uptake volume

- 1 Go to **Option > User settings > Calibr\_2**. Press **Run** to start the program.
- 2 Press **Calibrate**. The calibration is performed automatically.

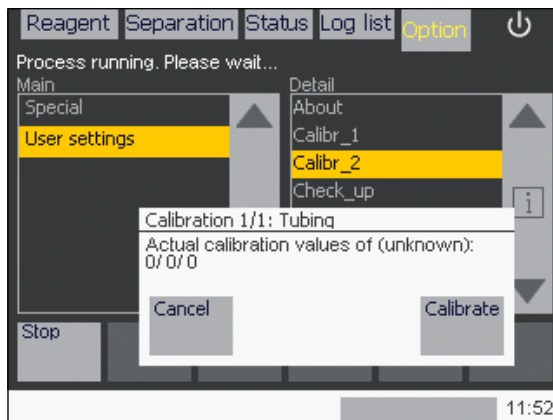

**Figure 5.15:** Calibration 2 Step 1/1.

- 3 Press **Save** to finish **Calibr\_2**.

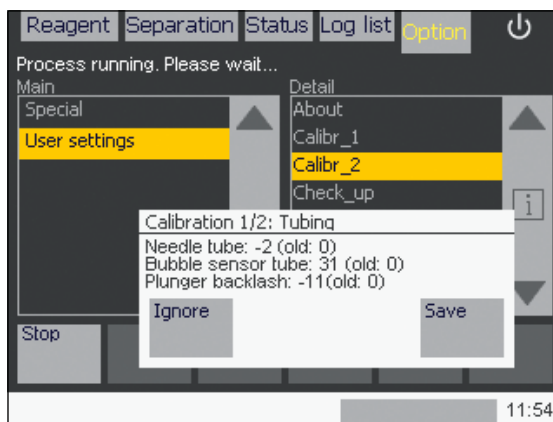

**Figure 5.16:** Calibration 2 Step 1/2.

# 6

## Cell separation

### WARNING

Read the instructions in the chapter **Important safety information** before operation of the instrument. When working with biohazardous samples, it is recommended to fill the waste bottle with 100 mL of disinfectant before use, e.g., bleach solution. For proper disposal, please follow your local regulations.

The autoMACS Pro Separator can perform fully automated cell separations. This includes all steps of the separation procedure, from cell labeling to sample loading, the separation over autoMACS Columns, and the collection of unlabeled and labeled cell fractions. Cell labeling can be performed manually or using the instrument's autolabeling feature. The pre-set separation programs of the autoMACS Pro Separator have been developed for optimal separation results, independent from the applied labeling and separation strategy.

Please be advised that the autoMACS Pro Separator is specified for use with MACS MicroBeads, autoMACS Columns and other genuine Miltenyi Biotec consumables and accessories only. Please use only consumables and accessories recommended by Miltenyi Biotec. The use of not recommended consumables and accessories may result in inaccurate results, instrument malfunction or damage, premature wear and reduced lifetime of the instrument. Miltenyi Biotec does not honor any warranty or accepts any responsibility for damages resulting from the use of inappropriate consumables or accessories.

## 6.1 Cell labeling strategies

There are two basic approaches for magnetic labeling of cells with MACS MicroBeads: direct and indirect magnetic labeling. For direct labeling, MACS MicroBeads bind directly to a specific cell surface marker protein. For indirect labeling, MACS MicroBeads recognize a primary antibody, its conjugates, or a ligand, binding to a specific cell surface marker protein.

### 6.1.1 Direct magnetic labeling

Direct labeling with MACS MicroBeads is the fastest way of magnetic labeling. MACS MicroBeads specifically bind to antigens on the cell surface. Only one incubation step is necessary. Direct magnetic labeling requires only a minimal number of washing steps and therefore minimizes cell loss. Highly specific cell separation reagents for direct labeling of numerous cell types with MACS MicroBeads are available for human, mouse, rat, and non-human primate cells.

### 6.1.2 Indirect magnetic labeling

Indirect magnetic labeling is a two-step procedure. First, cells are labeled with a primary antibody directed against a cell surface marker. The primary antibody can either be unconjugated, biotinylated, or fluorochrome-conjugated. Second, cells are magnetically labeled with MACS MicroBeads, which either bind to the primary antibody or to a molecule conjugated to the primary antibody. Accordingly, magnetic labeling is achieved with Anti-Immunoglobulin MicroBeads, Anti-Biotin MicroBeads, or Anti-Fluorochrome MicroBeads. Indirect labeling can also be performed using a cocktail of primary antibodies to concurrently label a number of unwanted cell types, e.g., for the untouched isolation of target cells.

## 6.2 Cell separation strategies

There are two basic strategies for separating specific cell populations: positive selection and depletion. During positive selection, the target cells are magnetically labeled and collected as the positive fraction. During depletion, the unwanted cells are labeled and depleted from the target cells. Furthermore, sequential sorting allows the performance of two consecutive separations.

### 6.2.1 Positive selection

To isolate a certain cell type, the target cells are magnetically labeled. During separation, the target cells are retained within the column. Unlabeled cells flow through and are collected as the negative fraction. After automated retraction of

the magnet, the magnetically labeled target cells are eluted from the autoMACS Column as the positive fraction. Positive selection can be performed after direct or indirect magnetic labeling using various MACS MicroBeads or MicroBead Kits. MACS Whole Blood MicroBeads are specially developed for the positive selection of leukocyte subsets directly from human whole blood or bone marrow.

### 6.2.2 Depletion

To remove a certain cell type from a mixture of cells, the unwanted cell type is magnetically labeled. During separation, the unwanted labeled cell type is retained within the column. The unlabeled target cells flow through the column and are collected as the negative fraction. After retraction of the magnet the retained cells are eluted from the autoMACS Column.

### 6.2.3 Untouched isolation

To isolate a particular target cell type in an unlabeled, i.e., untouched form, non target-cells are magnetically labeled and depleted. During separation, the unlabeled target cell type is collected in the flow-through, i.e., the negative fraction. The mixture of magnetically labeled non-target cells is retained within the autoMACS Column and will be eluted at the end of the separation process. MACS Cell Isolation Kits for untouched isolation contain a cocktail of titrated antibodies and MACS MicroBeads for indirect magnetic labeling. They are the preferred choice if binding of antibodies to the target cells is not desired.

### 6.2.4 Sequential sorting

A combination of two subsequent separations is applied to isolate cell subsets that can be distinguished from other cell types through their expression of two different markers. This includes cell types for which a specific marker has not been defined.

### 6.2.5 Depletion followed by positive selection

Use this strategy if both undesired cells and target cells carry the marker that is needed for separation. In this case, the target cells cannot be isolated in a single positive selection step. Therefore, the undesired cells expressing the common marker are magnetically labeled via antigens distinct from the common marker, and depleted. Cells in the flow-through fraction of the depletion step, including the target cells, are subsequently labeled with MACS MicroBeads that bind to the common marker. Target cells are then isolated by positive selection. Sophisticated MACS Cell Isolation Kits based on this strategy are available for fast and convenient isolation of specific cell subsets.



## 6.2.6 Two subsequent positive selections

Multiparameter sorting with MACS MultiSort MicroBeads allows the performance of two sequential positive selections according to two different markers. Labeling cells with MACS MultiSort MicroBeads specific for the first marker allows the first positive selection. After the separation, the cells are incubated with the MultiSort Release Reagent, which enzymatically removes the MultiSort MicroBeads from the cells. In the next step, the target cells are magnetically labeled with MACS MicroBeads directed against the second marker and again subjected to positive selection.

## 6.3 Separation programs

The autoMACS Pro Separator provides a selection of fourteen pre-set separation programs. The appropriate program is generally chosen depending on the separation strategy, the target cell frequency, and the level of antigen expression.

### 6.3.1 Positive selection programs

During the positive selection programs **Possel** and **Possels**, the magnetically labeled target cells are retained in the autoMACS Column 1. The unlabeled cells are released, as the negative fraction into the negative fraction collection tube, i.e., row **B** of the tube rack. After automated retraction of the magnet, the magnetically labeled cells are eluted as the positive fraction into the positive fraction collection tube, i.e., row **C** of the tube rack.

During the double-positive selection programs **Posseld**, **Posseld2**, **Posselds**, and **Posselwb**, the magnetically labeled target cells are first retained in the autoMACS Column 1. The negative fraction containing the non-labeled cells is retrieved in the negative fraction collection tube, i.e., row **B** of the tube rack. Then, the magnetically labeled cells are held in a reservoir and loaded onto the autoMACS Column 2. Again, the unlabeled cells are released into the negative fraction collection tube, i.e., row **B** of the tube rack. Finally, the magnetically labeled cells are eluted into the positive fraction collection tube, i.e., row **C** of the tube rack.

**Possel** – Positive selection in standard mode

Isolation of cells with frequencies higher than 5% and normal antigen expression.

**Possels** – Positive selection in sensitive mode

Isolation of cells with frequencies higher than 5% and low antigen expression.

Isolation of cells with frequencies higher than 5% and normal antigen expression, if recovery is the highest priority.

**Posseld** – Positive selection in standard mode I, double-column program  
Isolation of cells with frequencies lower than 5% and normal antigen expression, in a small elution volume.

**Posseld2** – Positive selection in standard mode II, double-column program  
Isolation of cells with frequencies lower than 5% and normal antigen expression, if purity is the highest priority.

**Posselds** – Positive selection in sensitive mode, double-column program  
Isolation of cells with frequencies lower than 5% and low antigen expression.

**Posselwb** – Special positive selection in special mode, double-column program  
Isolation of cell subsets from whole blood; cell samples are automatically diluted with Running Buffer.

**Posselbm** – Special positive selection, single-column program  
Isolation of cell subsets from bone marrow; cell samples are automatically diluted with Running Buffer.

**Pmalaria** – Special positive selection  
Special program for isolation of erythrocytes infected with *Plasmodium falciparum*.

### 6.3.2 Depletion programs

When running any depletion program, the magnetically labeled non-target cells are retained in the autoMACS Column 1. The non-labeled target cells pass through the column and are released into the negative fraction collection tube, i.e., row **B** of the tube rack. The magnetically labeled fraction, containing the unwanted cells, is eluted into the positive fraction collection tube, i.e., row **C** of the tube rack.

**Deplete** – Depletion in standard mode  
Removal of cells with normal antigen expression, if recovery is the highest priority.  
Untouched isolation with MACS Cell Isolation Kits.

**Deletes** – Depletion in sensitive mode I  
Removal of cells with normal antigen expression, if purity is the highest priority.  
Removal of cells with low antigen expression.  
Untouched isolation with MACS Cell Isolation Kits, if purity is highest priority.

**Depl05** – Depletion in sensitive mode II  
Removal of cells with low antigen expression, special program for very sensitive depletion

**Depl025** – Depletion in sensitive mode III

Removal of cells with low antigen expression, special program for very sensitive depletion. This special program is disabled by default. To enable, select **Option > User settings > O\_progs**.

**A\_Depl07\*** – Depletion in standard mode, sample loading in 1 mL batches

Removal of cells with normal antigen expression, if recovery is the highest priority. This special program is disabled by default. To enable, select **Option > User settings > O\_progs**.

**A\_Depls7\*** – Depletion in sensitive mode, sample loading in 1 mL batches

Removal of cells with low antigen expression, if purity is the highest priority. This special program is disabled by default. To enable, select **Option > User settings > O\_progs**.

Program	Volume of non-labeled fraction (i.e. negative fraction)	Volume of labeled fraction (i.e. positive fraction)	Loading rate
Possel	2 mL + sample volume	2 mL	4 mL/min
Possels	2 mL + sample volume	2 mL	1 mL/min
Posseld	2 mL + sample volume	0.5 mL	4 mL/min (column 1) 1 mL/min (column 2)
Posseld2	2 mL + sample volume	2 mL	4 mL/min (columns 1 and 2)
Posselds	2 mL + sample volume	2 mL	1 mL/min (columns 1 and 2)
Posselwb**	2 mL + 3× sample volume (predilution)	2 mL	4 mL/min (columns 1 and 2)
Deplete	2 mL + sample volume	2 mL	4 mL/min
Depletes	2 mL + sample volume	2 mL	1 mL/min
Depl05	2 mL + sample volume	2 mL	0.5 mL/min
Depl025	2 mL + sample volume	2 mL	0.25 mL/min
A_Depl07*	3 mL per 1 mL sample volume	2 mL per 1 mL sample volume	4 mL/min
A_Depls7*	3 mL per 1 mL sample volume	2 mL per 1 mL sample volume	1 mL/min

\* This program must be used with manual labeling. Please contact Miltenyi Biotec Technical Support before using these programs.

\*\* 3-fold predilution of the sample volume.

Table 6.1: Output volumes and loading rates of separation programs.

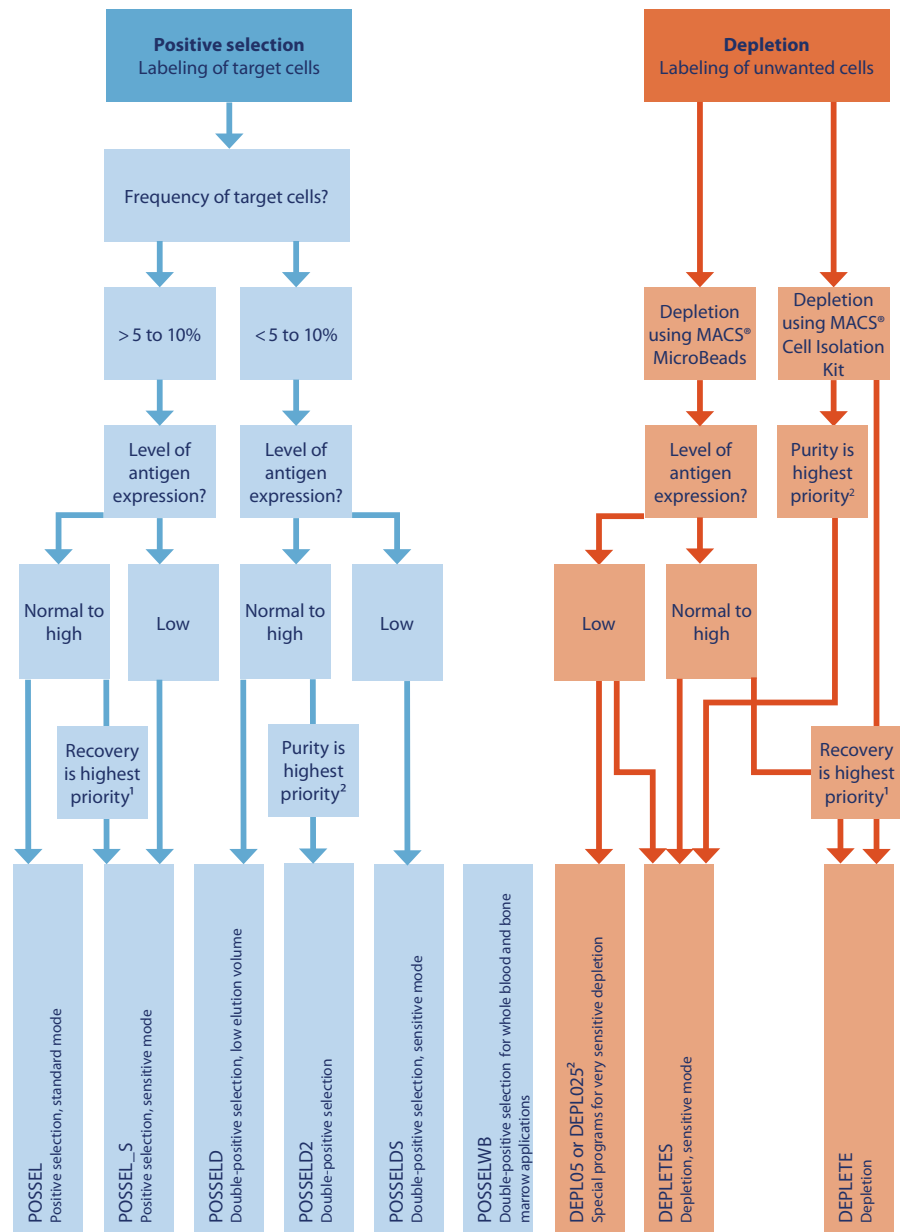

<sup>1</sup>Purity will slightly decrease  
<sup>2</sup> Recovery will slightly decrease

Figure 6.1: Selecting the optimal separation program

## 6.4 Wash and maintenance programs

The autoMACS Pro Separator is equipped with reusable autoMACS Columns. Therefore, after each cell separation, a thorough washing procedure rinses the columns of the autoMACS Pro Separator. After the wash program is completed, columns and tubing system are filled with Running Buffer. There are obligatory and optional wash programs, which have to be performed daily or at times to ensure proper operation and maintenance of the instrument.

### 6.4.1 Wash programs

**Qrinse** – Standard short wash program that only uses Running Buffer  
It is recommended to use this program between separations of cells with normal frequency.

**Rinse** – An extensive rinsing program that uses Washing Solution and Running Buffer. It is recommended to use this program between separations of rare cells, e.g., stem cells, the separation of cells from different species, and is mandatory between whole blood separations.

**Clean** – An optional, very extensive rinsing program  
It uses storage solution, Washing Solution, and Running Buffer. It may be used after whole blood and bone marrow applications. Clean has to be enabled first to appear in the **Wash** menu.

**Sleep** – Mandatory as the last wash program before overnight storage  
Upon completion of this program, the fluidic system contains 70% ethanol.

### 6.4.2 Maintenance programs

**Safe** – Designed for decontamination of the fluidic system  
Upon completion of this program, the fluidic system contains Running Buffer.  
The program includes an exchange of autoMACS Columns.

**Store** – Should be applied to prepare the instrument for long-term storage.  
Upon completion of this program, the fluidic system contains 70% ethanol.

**Col\_ex** – Used for column exchange  
Upon completion of the **Col\_ex** program, the fluidic system contains Running Buffer.

Program	Washing Solution	Running Buffer	Storage solution	Bleach solution (1% sodium hypochlorite)	Running time
Qrinse	—	48 mL	—	—	1.5 min
Rinse	96 mL	48 mL	—	—	4 min
Clean	96 mL	48 mL	48 mL	—	7 min
Sleep	96 mL	—	48 mL	—	5 min
Safe	96 mL	96 mL	—	40	21 min*
Store	96 mL	—	96 mL	—	8 min*
Col_ex	96 mL	96 mL	—	—	6 min*

\* Not including the time required for column exchange.

**Table 6.2:** Liquid usage and time of wash and maintenance programs.

## 6.5 Preparation of single-cell suspensions

Cell aggregates may contain mixtures of target and non-target cells and therefore can impair the separation results. MACS Separation Buffer/MACS Running Buffer should be used during sample handling steps to minimize the risk of cell aggregation. Resuspend cells carefully after centrifugation. Large cell aggregates may interfere with the separation process and may cause pressure variations in the autoMACS Pro fluidic system. It is recommended to use Pre-Separation Filters, 30  $\mu\text{m}$  (# 130-041-407) or Pre-Separation Filters, 70  $\mu\text{m}$  (# 130-095-823) to remove cell clumps that may clog the column.

Dead cells and cell debris may bind non-specific to MACS MicroBeads, antibodies, and antibody conjugates. To remove dead cells, it is recommended to use density gradient centrifugation or the Dead Cell Removal Kit (# 130-090-101). For specific recommendations on the preparation of single-cell suspensions, please refer to the respective Cell Separation Reagent data sheet.

## 6.6 Adjusting sample volumes

Typically,  $1 \times 10^7$  cells are resuspended in 80  $\mu\text{L}$  of buffer and labeled with 20  $\mu\text{L}$  of MicroBeads, leading to a total labeling volume of 100  $\mu\text{L}$ . When working with higher cell numbers, scale-up all reagent volumes and total volumes accordingly. For example, for  $2 \times 10^7$  total cells use twice the volume of all indicated reagent volumes and total volumes indicated in the respective data sheet. When working with fewer than  $1 \times 10^7$  cells, do not scale down the volumes, but use the same volumes as indicated.

In the table below, the dilution volumes account for the first step of labeling. For manual labeling, please refer to the respective Cell Separation Reagent data sheet for ongoing procedures. Minimal and maximal volumes and total cell numbers in table 6.3 account for autolabeling samples only. Autolabeling protocols are being continually developed and optimized by Miltenyi Biotec. For a current list of Cell Separation Reagents that are optimized for cell separations with the autoMACS Pro Separator autolabeling feature, please contact Technical Support.

Cell Separation Reagent	Strategy	Nr. of reagents	Dilution volume	Autolabeling			
				Minimal volume*	Minimal total cell number	Maximal volume	Maximal total cell number
<b>Chill 5 Rack<sup>1</sup></b>							
Direct MicroBeads human, rat, non-human primate	Positive selection or depletion	1	10 <sup>7</sup> cells per 80 µL	160 µL	2×10 <sup>7</sup>	1600 µL	2×10 <sup>8</sup>
Direct MicroBeads, mouse	Positive selection or depletion	1	10 <sup>7</sup> cells per 90 µL	180 µL	2×10 <sup>7</sup>	1800 µL	2×10 <sup>8</sup>
Whole Blood MicroBeads	Whole blood or bone marrow	1	Original volume	0.25 mL		1 mL	
Cell Isolation Kits	Untouched isolation	2	10 <sup>7</sup> cells per 40 µL	160 µL	4 ×10 <sup>7</sup>	800 µL	2×10 <sup>8</sup>
Cell Isolation Kits	Untouched isolation	3	10 <sup>7</sup> cells per 30 µL	120 µL	4×10 <sup>7</sup>	600 µL	2×10 <sup>8</sup>
<b>Chill 15 Rack<sup>2</sup></b>							
Direct MicroBeads human, rat, non-human primate	Positive selection or depletion	1	10 <sup>7</sup> cells per 80 µL	160 µL	2×10 <sup>7</sup>	5200 µL	6.5×10 <sup>8</sup>
Direct MicroBeads, mouse	Positive selection or depletion	1	10 <sup>7</sup> cells per 90 µL	180 µL	2×10 <sup>7</sup>	5850 µL	6.5×10 <sup>8</sup>
Whole Blood MicroBeads	Whole blood or bone marrow	1	Original volume	1 mL		4 mL	
Cell Isolation Kits	Untouched isolation	2	10 <sup>7</sup> cells per 40 µL	160 µL	4×10 <sup>7</sup>	2600 µL	6.5×10 <sup>8</sup>
Cell Isolation Kits	Untouched isolation	3	10 <sup>7</sup> cells per 30 µL	120 µL	4×10 <sup>7</sup>	1950 µL	6.5×10 <sup>8</sup>
<b>Chill 50 Rack<sup>3</sup></b>							
Whole Blood MicroBeads	Whole blood or bone marrow	1	Original volume	4 mL		8 mL	

<sup>1</sup> Max. number of samples: 6; min. first incubation volume: 0.2 mL; max. final labeling volume: 2 mL

<sup>2</sup> Max. number of samples: 5; min. first incubation volume: 0.2 mL; max. final labeling volume: 6.5 mL

<sup>3</sup> Max. number of samples: 3; min. first incubation volume: 4 mL; max. final labeling volume: 8 mL.

\*When working with fewer cells than the necessary minimal volume, resuspend cells in the stipulated minimal volume.

**Table 6.3:** Dilution volumes for the first labeling step and MACS Chill Rack specifications for autolabeling, including minimal and maximal volumes and cell numbers.





## 6.7 Selecting the appropriate tube rack

Three different tube racks are available for processing sample volumes between 0.2 mL and 50 mL. Unless otherwise specifically indicated in the Cell Separation Reagent data sheet, the magnetically labeled cell samples are resuspended at  $10^8$  total cells per 500  $\mu$ L when using manual labeling. The cell numbers and volumes for autolabeling are slightly different. Refer to table 6.3 for further details.

- Row **A** of the Chill Rack holds the sample tubes (Ori).
- Row **B** of the Chill Rack holds the tubes for the non-labeled fractions (negative fractions, Neg).
- Row **C** of the Chill Rack holds the tubes for labeled fractions (positive fractions, Pos).
- Optional: For your convenience, Row **D** can hold round-bottom tubes for further analyses.

Select the appropriate tube rack according to table 6.4. It is recommended to cool down the tube rack for 3–4 hours in a refrigerator (2–8 °C) or until the coolant becomes solid. Do not cool below 0 °C, as samples may freeze. Tube racks will stay cool for 2-2.5 hours. Equip the tube rack with sample tubes and fraction collection tubes.

Rack type and symbol	Slots	Maximal number of samples	Manual labeling	Autolabeling	
			Maximal sample volume	Minimal first incubation volume	Maximal final labeling volume
Chill 5 	24x5 mL	6 (5 mL tubes)	2.5 mL	0.2 mL 0.25 mL*	2.0 mL 1 mL*
Chill 15 	15x15 mL 5x5 mL	5 (15 mL tubes)	12.5 mL	0.2 mL 1 mL*	6.5 mL 4 mL*
Chill 50 	6x50 mL 3x15 mL	3 (50 mL tubes)	50 mL	4 mL*	8 mL*

\*Volumes refer to whole blood samples only.

**Table 6.4:** MACS Chill Rack specifications for manual labeling and autolabeling.

## 6.8 Monitoring the separation process

It is recommended to monitor the instrument's status before and during cell separation. Select the Status menu tab to check the program status. Further, fluid bottle illumination also indicates the instrument's status.

### 6.8.1 Program status

The background color of the sample fields indicates the sample status (see table 6.5 and section 4.3). The current action is always displayed in the status bar located below the lower navigation bar. The status bar also displays the overall progress in minutes.

Color	Program status
Yellow	Yet to be processed
Purple	Currently undergoing autolabeling
Orange	No autolabeling (manual labeling)
White	Process is completed
Red	Process was cancelled

**Table 6.5:** Program status during separation.

### 6.8.2 Interrupting cell separation

Cell separation can be paused at any time from all menu screens by pressing the **Stop** button at the lower left side of the screen. The autoMACS Pro Separator will then immediately stop operation and will display a pop-up dialog box. Press **Cancel** to quit the current process. Press **Continue** to resume the current process.

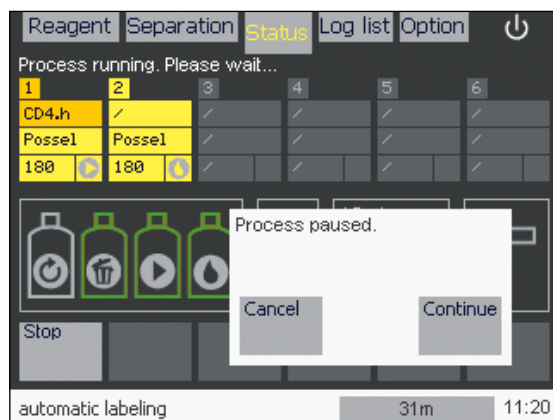

**Figure 6.2:** Pausing or canceling cell separation.

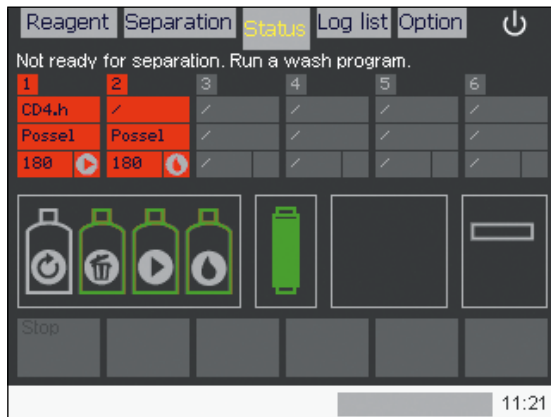

**Figure 6.3:** Cell separation has been canceled.

### 6.8.3 Fluid bottle illumination

The autoMACS Pro Separator has a fluid bottle illumination that facilitates monitoring of the instrument's status. Blinking indicates that user action is required. In this case, check the screen for required action. The fluid bottle illumination can be switched on or off (see section 4.5.2).

Color	Status	User action
Green	Ready for separation	No action required
Blue	Instrument operating	No action required
Yellow	Not ready for separation	Run wash program ( <b>Rinse</b> or <b>Qrinse</b> ) before starting a separation
Red	Error	Check screen for error detection
Purple	Program <b>Sleep</b> is completed	Switch off autoMACS Pro Separator
Blinking	Action required	Check screen for required action

**Table 6.6:** Fluid bottle illumination status.

## 6.9 Priming the autoMACS Pro Separator

Priming implicates the initial rinsing and filling of the autoMACS Pro Separator tubing system before performing cell separations. The autoMACS Pro Separator must be primed each time the instrument is switched on. Ensure that the MACS MiniSampler Plus has been installed, the waste bottle is empty, and that all fluid bottles are filled with recommended solutions (refer to section 2 and 3 for more details). Fill waste bottle with 100 mL disinfectant, if necessary. At this point, the fluid bottles are illuminated yellow.

If the instrument has not been primed yet, the autoMACS Pro Separator will automatically ask to run a **Rinse** program before starting the separation. It is possible to include an initial **Rinse** program that will be performed automatically upon switching on the instrument. The setting of this option **O\_init** is described in section 4.5.2.

- 1 Switch on the autoMACS Pro Separator and wait for the instrument to complete initialization.
- 2 After initialization, the autoMACS Pro Separator will display the **Status** menu (see section 4.1 for more information about the **Status** menu).
- 3 Ensure that the symbols for the fluid bottles are colored green. Note that the symbol for the rinse bottle always remains gray.
- 4 Ensure that the symbol for the columns is colored green.
- 5 Ensure that the MACS MiniSampler Plus is installed correctly. For more details concerning correct installation of the MACS MiniSampler Plus refer to section 2.6.
- 6 The autoMACS Pro Separator is now ready for priming. Go to the **Separation** menu and press **Wash Now**. You now have the option to perform a quick rinse (**Qrinse**) or full rinse (**Rinse**).
- 7 Select **Rinse** and press **Run** to start the priming process. The progress will be displayed at the bottom of the touchscreen menu.
- 8 When priming is finished, the instrument will display **Ready for separation** in the **Status** menu. The fluid bottles are now illuminated green.

## 6.10 Cell labeling and separation

After completing the wash program, the autoMACS Pro Separator is ready for separation. The status of the instrument is displayed in the **Status** menu. The fluid bottles are illuminated green. Cells can be labeled manually or using the autoMACS Pro Separator autolabeling function. Autolabeling and manual labeling may be assigned to independent samples and run in one separation program. For detailed information about manual labeling, refer to the respective reagent data sheet. For a variety of labeling reagents, Miltenyi Biotec has developed autolabeling protocols. Please contact Miltenyi Biotec for a list of labeling reagents that are optimized for autolabeling. **CAUTION!** Do not look directly at the light emitted by the bar code reader. Eye injury may result. Do not activate the 2D bar code reader if the washing station cover is open.

### 6.10.1 Cell separation using the autolabeling function

- 1 Go to the **Separation** menu.
- 2 In the sample rack template field, highlight the desired sample position(s).
- 3 Assign a reagent for autolabeling from the **Labeling** submenu to each position. Reagents can be assigned manually or using the 2D code reader. Please refer to section 4.2 for details. The recommended separation and wash programs will be automatically displayed in the **Separation** menu.
- 4 **Optional:** The pre-selected separation and wash programs can be changed in the corresponding submenus.
- 5 Go to the **Volume** submenu and enter the sample volume using the numeric keypad. Press **Enter**.
- 6 Press **Run. Note:** The autoMACS Pro Separator ensures that there is enough solution for one separation. If more than one separation is to be performed, the user should check whether there is enough solution in the bottles. Therefore, a pop-up window will ask the user to check and confirm the filling status before proceeding to separation. Press **Continue** to proceed.

### 6.10.2 Cell separation after manual labeling

- 1 Go to **Separation** menu.
- 2 Highlight the desired position(s) in the sample rack template field.
- 3 Select  from the **Labeling** submenu for manual labeling.
- 4 **Optional:** It is not mandatory to assign a volume for manually labeled samples. However, the autoMACS Pro Separator requires this information to calculate and display the total sample processing time. Enter the sample volume in the **Volume** submenu using the numeric keypad. Press **Enter**.
- 5 Select a separation program and a washing program for each sample position. The selected programs will be displayed in the programming field.
- 6 Press **Run. Note:** The autoMACS Pro Separator ensures that there is enough solution for one separations. If more than one separation is to be performed, the user should check whether there is enough solution in the bottles. Therefore, a pop-up window will ask the user to check and confirm the filling status before proceeding to separation.
- 7 Press **Continue** to proceed.

### 6.10.3 Working with templates

For convenience, it is possible to save reagent and separation templates. Reagent templates can be used in combination with separation templates. The autoMACS Pro Separator automatically detects the type of tube rack in use and allows the user to utilize only the number of samples and sample positions the tube rack can handle. If the tube rack does not match the template definition, a warning screen will be displayed upon starting the separation.

#### 6.10.3.1 Saving a reagent template

- 1 In the **Reagent** menu, assign reagent vials to reagent rack positions.
- 2 Press **Save Template**.
- 3 Allocate a name to the template.
- 4 Press **Ok**.

#### 6.10.3.2 Saving a separation template

- 1 In the **Separation** menu, configure the sample template.
- 2 Press **Save Template**.
- 3 Allocate a name to the template.
- 4 Press **Ok**.

#### 6.10.3.3 Loading a template

- 1 In the respective menu (**Reagent** or **Separation** menu), press the **Load Template** button. To scroll through the list of saved templates using the navigation arrows.
- 2 Select the desired template(s).
- 3 Press **Ok**.
- 4 Press **Run** to start the separation.

#### 6.10.3.4 Deleting a template

- 1 In the respective menu (**Reagent** or **Separation** menu), press **Load Template** from the lower navigation bar.
- 2 Scroll through the list of saved templates using the navigation arrows.
- 3 Select the template for deletion.
- 4 Press **Delete Template**.

## 6.11 Shutting down the instrument

If the instrument is to be shut down after separation, the **Sleep** program can be chosen as a wash program after the last separation instead of **Rinse** or **Qrinse**. However, if **Sleep** is chosen as a wash program, the autoMACS Pro Separator will not allow definition of any programs beyond this position. Alternatively, press the shutdown button on the upper right hand corner of the screen and confirm. Upon completion of the **Sleep** program, the fluid bottles are illuminated purple. Switch off the autoMACS Pro Separator using the main power switch. **Note:** The autoMACS Pro Separator automatically performs the **Sleep** program if the device is inactive for more than six hours. For long-term storage of the instrument, refer to section 3.2.2.

# 7

## Maintenance



Read the chapter **Important safety information**. Do not service the equipment yourself, unless the procedure is described in this manual. All other service shall be carried out only by trained experts authorized by Miltenyi Biotec. An improperly serviced instrument may lead to severe personal injury or death by exposure to mechanical hazards, hazardous optical radiation, and the risk of electric shock. Unplug the power cord before cleaning the instrument. Always wear protective gloves and eyewear in order to protect against potential biohazard exposure. Dispose of contaminated tissues and swabs according to their biological security level.

Three service contracts are available for the autoMACS Pro Separator: Full Service Premium, Full Service, and Planned Maintenance. Please visit [www.miltenyibiotec.com/support](http://www.miltenyibiotec.com/support) for further information and assistance. In addition, it is recommended to perform the following maintenance procedures to maintain the instrument's high performance.

### 7.1 Daily maintenance

#### 7.1.1 Instrument priming

The autoMACS Pro Separator must be primed each time the instrument is switched on. The **Rinse** program is used for efficient washing and equilibration of the fluidic system. The instrument automatically prompts the user to perform a rinse before performing a cell separation.

- 1 Go to the **Separation** menu and press **Wash Now**.
- 2 Select **Rinse** and press **Run**.



### 7.1.1.1 Automatic instrument priming at startup

By using the **O\_init** program, the instrument can be instructed to perform an automated rinse sequence at startup.

- 1 Select **Option > User settings > O\_init**. Press **Run**.
- 2 Follow the prompt on the screen to enable or disable the initial wash.

### 7.1.2 Clean uptake/outlet ports

It is recommended to clean uptake and outlet ports daily. This should be performed before running the **Sleep** program (shutdown).

- 1 Switch off the instrument.
- 2 The ports can be wiped with tissue soaked with 70% ethanol, isopropyl alcohol, or bleach solution (1% sodium hypochlorite) followed by distilled or deionized water.
- 3 Remove the needle guard that is attached underneath the outlet port holder: Push up the ring holding the the finger guard in place. Remove the finger guard by pulling gently. Clean the finger guard as described for the ports.



**Figure 7.1:** Removing the needle guard for cleaning.

- 4 Wipe the outlet port for the negative fraction as indicated above. Flush the port using a syringe, if desired.
- 5 To clean the uptake port, ensure the instrument is switched off. Move the needle holder up and down to get access to the entire surface of the needle.
- 6 Push the needle guard back into position.
- 7 Switch on the instrument.
- 8 Run the **Sleep** program.

## 7.2 Periodic maintenance

### 7.2.1 Column exchange

Exchange autoMACS Pro Separator Columns every other week or after 100 separations, whichever comes first. Refer also to section 3.1.1.2.

- 1 Open the front door of the autoMACS Pro.
- 2 Ensure that the fluid bottles are filled with solutions.
- 3 Got to **Option > Special > Col\_ex**.
- 4 Press **Run** to start the **Col\_ex** program.
- 5 Wait until the instrument prompts you to exchange the autoMACS Columns before proceeding.
- 6 Using both hands, take the top and bottom of column 1 and pull gently but firmly to remove it from its slot.
- 7 Place a wide mouth bottle under the column.
- 8 Hold the column in one hand and gently unscrew the bottom column connector counter-clockwise. Unscrew the top column connector while holding the column over the bottle to catch any fluids.
- 9 Insert one end of a fresh column into the bottom column connector and gently screw in the column by turning it clockwise until you feel a resistance. Point the column towards the top of the instrument and screw in the top column connector.
- 10 Align the column with the top column connector sitting on the guiding of the magnet cover. Press the column into the slot until the guides click. Verify that the column is placed in the center of the magnet cover.
- 11 Remove column 2 from its slot and repeat steps 8 through 11 to install the second column.
- 12 Ensure that the tubing is neither pinched nor obstructed.
- 13 Press **Done**.
- 14 The program will then proceed to wash the columns with autoMACS Running Buffer. Check that the columns are securely fastened to the column connectors and that no buffer is leaking.
- 15 Close the front door.

## 7.2.2 Exchange of hydrophobic air filters

Hydrophobic air filters (0.2 µm) are attached to the bottle closures to vent the liquid bottles and to prevent release of aerosols. They should be exchanged once a year to avoid clogging through dust deposits. To avoid clogging of the filters and to prevent contamination of liquids, air filters should be exchanged if they come into direct contact with any liquid. **Note:** Be sure to use **hydrophobic** air filters. These are **not** the same as filters used for cell culture.

## 7.2.3 Clean the pump syringe

Depending on the level of usage, the pump syringe must be cleaned every 1–3 months. Appropriate maintenance and long-term storage assures that no salt deposits accumulate in the pump syringe. Salt deposits may cause wear of the pump seal and thus may lead to leakage. The pump syringe should not run dry at any time. This can damage the pump seal and thereby may lead to leakage.

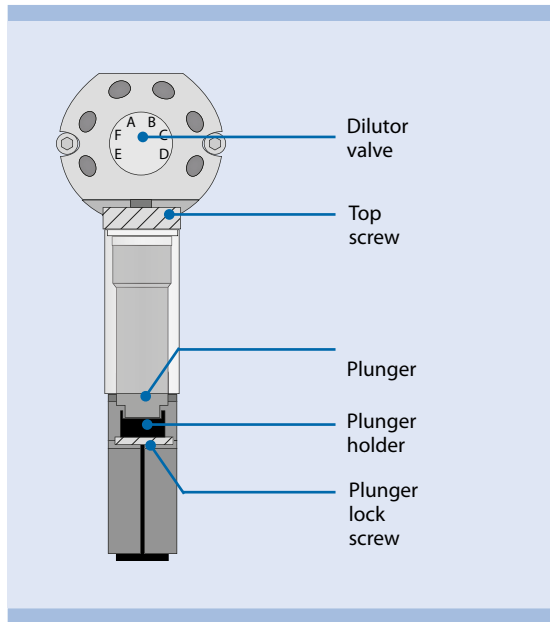

**Figure 7.2:** Dilutor valve with pump syringe.

- 1 Go to **Option > User settings > Syrin\_ex**.
- 2 Press **Run** to start the program.

- 3 When prompted, loosen the plunger lock screw at the bottom of the plunger.

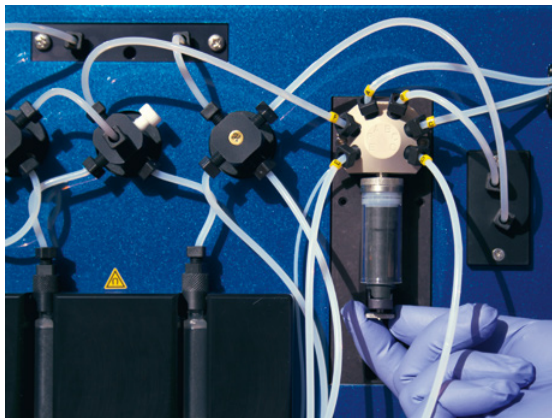

**Figure 7.3:** Unscrewing the plunger lock screw.

- 4 Press **OK**. The plunger holder will move to the lowest position.

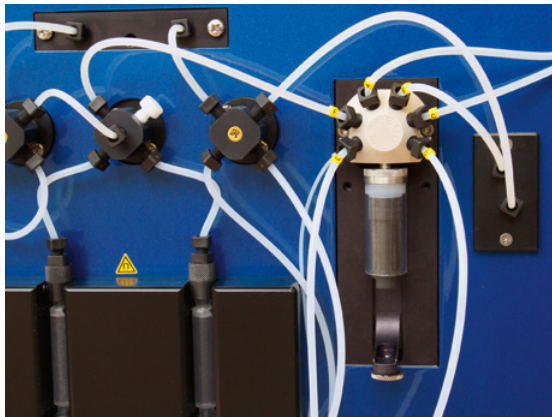

**Figure 7.4:** The plunger holder is in the lowest position.

- 5 A dialog window will prompt the user to switch the instrument off, replace the syringe, and tighten the plunger screw. Press **OK** to confirm.
- 6 Switch off the instrument using the main switch.
- 7 Unscrew the syringe from the dilutor valve housing by turning the knurled top screw counter-clockwise. Grip the syringe at the top screw only. Do not compress the glass, as it might break.
- 8 Carefully remove the plunger from the syringe. Place a container underneath to prevent spilling. Remove salt crusts with distilled or deionized water.



**Figure 7.5:** Wash the syringe with distilled water.

- 9 Gently push the plunger halfway into the syringe. Dry the plunger lock screw before proceeding with installation of the syringe.
- 10 Fasten the syringe at the diluter valve by turning the top screw clockwise until a resistance is met. Unfasten again by one rotation. Grip the syringe at the top knurled screw only. Do not compress the glass, as it might break.
- 11 Pull the plunger out of the syringe until it reaches its fitting in the plunger holder. The plunger must have the same orientation as the fitting (see figure 7.2). Tighten the plunger lock screw.



**Figure 7.6:** Place the plunger in its fitting and tighten the plunger lock screw

- 12 Tighten the syringe at the diluter valve by turning until a resistance is met.
- 13 Switch on the instrument. The plunger holder will move up again.
- 14 Prime the autoMACS Pro Separator as described in section 3.1.3.
- 15 Run the program **Calibr\_2** to calibrate the fluidic volume control of the instrument. Refer to section 5 for details.

## 7.2.4 Cleaning the washing station

The washing station is designed for automated rinsing of the outlet and uptake ports as well as surface cleaning of the uptake and outlet port needle. The washing station should be cleaned as necessary to remove spills and salt crusts. Do not autoclave the washing station or wash using a dishwasher. **Note:** This procedure requires a column exchange.

- 1 Switch off and unplug the instrument.
- 2 Make sure that the needle arm is in the uppermost position.
- 3 Swivel the front cover to the right side; swivel the cover of the washing station to the left side. The cover can be removed by lifting it.
- 4 Press the tubing clamp on the right hand side of the washing station and pull to remove the tubing.



**Figure 7.7:** Remove the peristaltic pump tube from the washing station.

- 5 Unscrew the knurled screw that attaches the washing station to the instrument.

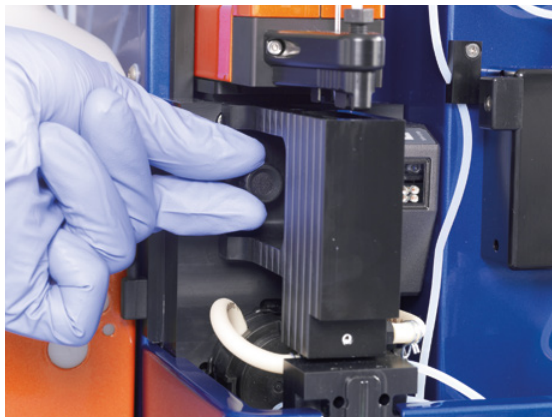

**Figure 7.8:** Unscrew the knurled screw.

- 6 Pull out the washing station.
- 7 Clean the washing station by soaking it in 10% bleach and 70% ethanol for 15 min each. Optionally, sonicate it in water. Rinse with distilled water.
- 8 Reassemble the unit in reverse order.
- 9 Run a **Safe** program.

### 7.2.5 Instrument disinfection

The **Safe** program is a disinfectant procedure for cleaning of the autoMACS Pro Separator. It is recommended to use a disinfectant based on bleach solution (1% sodium hypochlorite). Depending on the level of use and general instrument maintenance, it is recommended to run the **Safe** program every 3 to 6 months to disinfect the fluidic system. If predominantly whole blood, bone marrow, or tissue samples are separated, the **Safe** procedure can be performed more often without harming the instrument, e.g., every four weeks. As the **Safe** program requires a column exchange, the periodic column exchange can be omitted if running the **Safe** program regularly. **CAUTION!** If sample tubes and fraction collection tubes have been in contact with biohazardous material, they should be autoclaved after use. Bottle closures can be autoclaved. Neither autoclave the washing station nor wash it in a dishwasher.

In case of spillage, it is recommended to use an appropriate disinfectant, e.g., bleach solution (1% sodium hypochlorite), isopropyl alcohol, or 70% ethanol, to decontaminate surfaces with tissue or swabs. Switch off and unplug the instrument before disinfection. Dispose tissues and swabs appropriately. It is recommended to wear protective gloves, protective clothing, and safety glasses to prevent contact with skin and eyes.

- 1 Go to **Option > Special > Safe** and press **Run** to start the program. Follow the screen prompts.
- 2 Disconnect the tubings from storage solution and buffer bottles. Press **OK**.
- 3 Place the ends of the tubing in a minimum of 15 mL of disinfectant solution. Press **OK**.
- 4 Fill a sample tube with 25 mL of disinfectant solution. Press **Done**.
- 5 Optional: Wash fluid bottles and bottle closures using detergent, 1% hypochlorite, or 70% ethanol. Rinse thoroughly using deionized water.
- 6 Reconnect all tubing. Press **OK**.
- 7 Clean the entire needle manually using 70% alcohol. Press **OK**.
- 8 Install fresh columns. Press **OK**.

## 7.3 Corrective maintenance

Four valves regulate the fluidic system of the autoMACS Pro Separator. A fifth valve, referred to as dilutor valve, is connected to the pump syringe. Service plans for preventive and corrective maintenance are available at [www.miltenyibiotec.com](http://www.miltenyibiotec.com). However, if leakage occurs, the user can exchange valves and tubing.

### 7.3.1 Valve exchange

- 1 Go to **Option > User settings > Valve\_ex**.
- 2 **Press Run** to start the program. Select valves that have to be exchanged. Valves will automatically be turned to exchange position. **Note:** In case the valve exchange program **Valve\_ex** cannot be performed, e.g., valve does not turn, switch off instrument and turn the valve bracket manually to the position corresponding to the groove in the valve drive.
- 3 Switch off and unplug the autoMACS Pro Separator. Open the front door. For exchange of the lower valve, remove the bottom cover by pulling firmly.

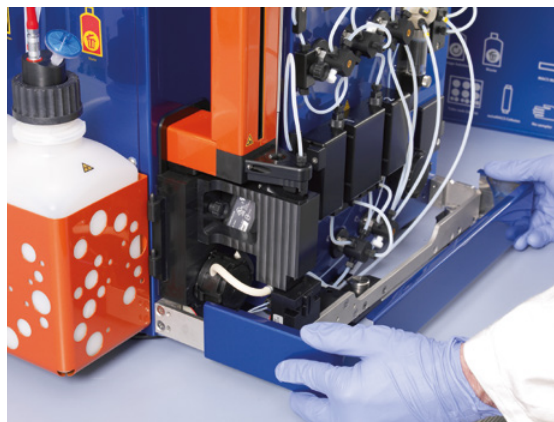

**Figure 7.9:** The bottom cover must be removed for access to the lower valve.

- 4 Unscrew the valve cover-screw that releases the tubing with the supplied wrench.





**Figure 7.10:** Unscrew the valve cover-screw.

- 5 Detach all tubing and valve port locks or blind screws from the respective valve.



**Figure 7.11:** Unscrew the valve cover-screw and detach tubing and valve port locks or blind screws.

- 6 Loosen the two valve screws using the screwdriver (contained in the autoMACS Pro Separator – Starter Kit) and pull out the valve.

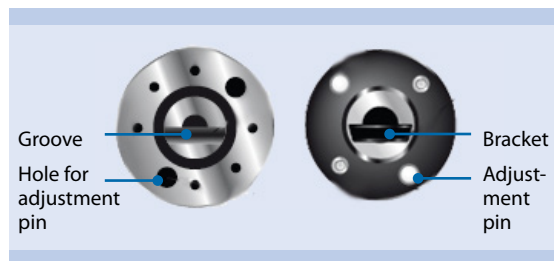

**Figure 7.12:** Loosen the valve screws.



**Figure 7.13:** Detach the valve.

- 7 Check if the groove in the valve drive is positioned horizontally and in the lower half of the axis.



**Figure 7.14:** Left: Valve plate driving section. Right: Rear view of the autoMACS Pro Separator valve.

- 8 Make sure that the bracket of the new valve is positioned horizontally.

- Carefully insert the new valve allowing the bracket to find the groove in the drive. At first, the bracket will slide in only halfway.

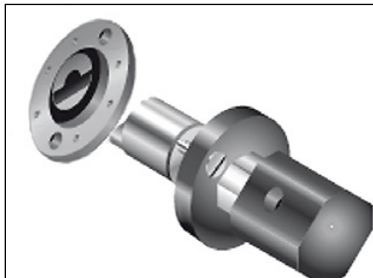
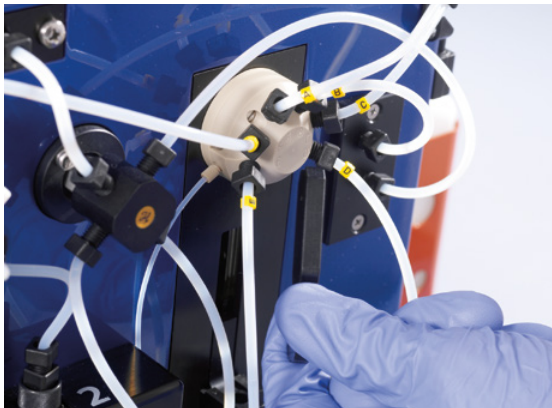

**Figure 7.15:** Inserting the new valve.

- Gently rotate the valve. The two adjustment pins will slide into their corresponding holes in the valve plate.
- Make sure that the valve is fully inserted into the driving station. Fasten valve screws using the screwdriver.
- Connect the tubing with the installed new valve and fasten tubing finger-tight.
- Plug in and switch on the autoMACS Pro Separator.
- Perform a **Rinse** program and check the valves visually for leakage and air inlet.
- Carefully refasten tubing connectors. If leakage persists call Technical Support.
- Take care not to pinch the tubings at the bottom left of the instrument when closing the bottom cover.

### 7.3.2 Dilutor valve exchange

- Switch off and unplug the instrument.
- Remove the pump syringe as described in section 7.2.3.



**Figure 7.16:** Unscrewing the tubing connected to the dilutor valve.

- 4 Unscrew the two hexagonal socket screws using the allen key that was delivered with the new or exchange valve.



**Figure 7.17:** Unscrewing the dilutor valve's socket screws.

- 5 Pull the dilutor valve out of the coupling.
- 6 Insert the new valve. Contact Tech Support for assistance.
- 7 When the dilutor valve is properly inserted, mount the hexagonal socket screws.
- 8 Connect the tubing according to the letters on the diluter valve and tubing.

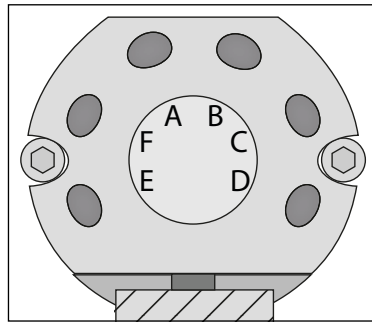

**Figure 7.18:** Connect tubing to the dilutor valve as indicated by the letters.

- 9 Guide the draining tube towards the washing station as shown below.

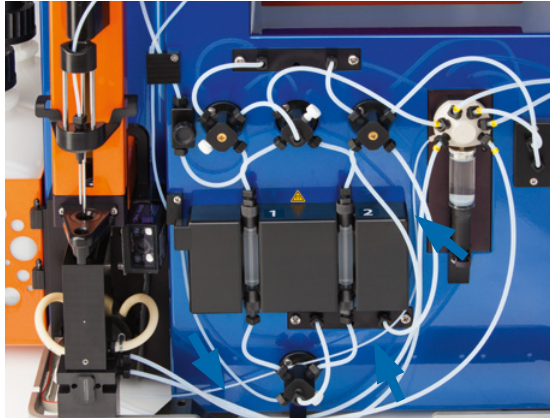

**Figure 7.19:** The draining tube connects the valve to the washing station.

10 Remove the washing station. Take care to clean spilled fluids with ethanol or disinfectant.



**Figure 7.20:** Dismantle the washing station.



**Figure 7.21:** Dismantle the washing station.

11 Carefully remove the waste distributor from its position by pulling in an upward direction and remove the draining tube from the old diluter valve.



**Figure 7.22:** Removal of the waste distributor.

- 12 Mount the new draining tube and finger tighten. Take care to clean spilled fluids with ethanol or disinfectant.



**Figure 7.23:** The draining tube is attached.

- 13 Install the waste distributor back to its former position and reinstall the washing station.
- 14 Install the syringe pump.
- 15 Switch on the autoMACS Pro Separator.
- 16 Check for correct function by running the **Rinse** program.
- 17 Run the program **Calibr\_2** to calibrate the fluidic volume control of the instrument.

### 7.3.3 Exchange of the peristaltic pump head

- 1 Switch off and unplug the instrument.
- 2 Remove the washing station as described in section 7.2.4, steps 1–6.
- 3 Press the tubing clamp on the left hand side of the waste distributor and remove the tubing.



**Figure 7.24:** Disconnecting the tubing from the waste distributor.

- 4 If necessary, pull out the bottom cover as depicted in figure 7.9.
- 5 Press clamps on both sides of the pump and pull out the pump head.



**Figure 7.25:** Detachment of the pump head.

- 6 This will uncover a pin that protrudes from the instrument. The pin drives the pump during operation. Clean the pin using 70% ethanol but do not pull it out.
- 7 Replace pump head with the spare part.
- 8 Reassemble in reverse order. Take care not to pinch the tubing at the bottom left when pushing the bottom cover back into place.

### 7.3.4 Exchange of tubing system

If there is any leakage in the tubing system, try to tighten all connections first (refer to section 9.2.2 for details). However, if leaking persists, an exchange of tubing might be required. Please note that each tube has a specific length and should be exchanged with the corresponding spare part only.

- 1 Switch off and unplug the instrument.
- 2 Remove the affected tubing by loosening the tube connectors using the black wrench.
- 3 Replace the tubing with the correct part.
- 4 Pull back the connector from the tubing, so that the tubing can be easily inserted into the appropriate port.
- 5 Insert the connector cautiously and precisely and fasten it by hand. Make sure not to overtighten the screw.
- 6 Plug in and switch on the instrument. Run the program **Rinse** and check for leakage.
- 7 Run the **Calibr\_2** program to calibrate the volume control of the instrument. For details, refer to section 5.
- 8 If there is still any leakage, refer to section 9.2.

### 7.3.5 Exchange of fuses

If the instrument fails to start upon switching it on or if operation suddenly stops and the screen turns dark, an exchange of the fuses might be required.

**CAUTION!** Fuse specifications are given on the marking plate on the rear of the instrument close to the fuse holder. Do not use other fuses than specified.

- 1 Switch off the instrument.
- 2 Unplug the main power cord from the power outlet as well as from the instrument. The fuse holder is located below the main power connector on the rear panel of the instrument.
- 3 Pull out the fuse holder from the housing and exchange fuses.



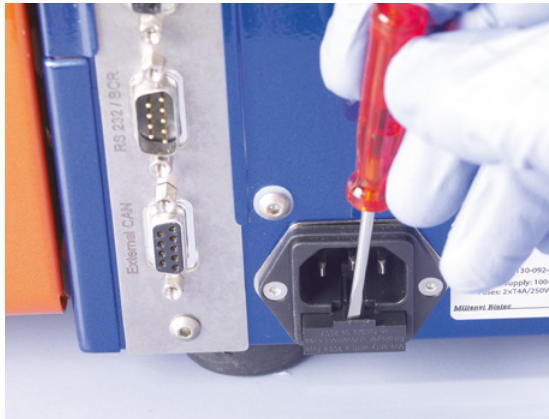

**Figure: 7.26:** Removing the fuse holder.

- 4 Push the fuse holder back into the housing and reconnect the main power cord.

# 8

## Quality Control

To evaluate any MACS Cell Separation, the separated cells can be analyzed with regard to purity, recovery, and viability. Using MACS MicroBeads, the magnetically labeled cells can be simultaneously stained with fluorochrome-conjugated antibodies. Antibodies of the same specificity can be used in most cases. MACS Fluorochrome-conjugated Antibodies are standardized to evaluate MACS Cell Separations. The stained cells can subsequently be analyzed by flow cytometry, fluorescence microscopy, or other techniques. To count the cells of the original fraction, collect an aliquot of the cell sample after magnetic labeling directly before the magnetic separation to analyze whether cell losses are due to centrifugation steps OR to magnetic separation. Also take counting statistics into consideration. The standard deviation when counting cells is  $N \pm N^{1/2}$ . Therefore, cell counting might be associated with large statistical errors.

### 8.1 Cell recovery

In most cases, the number of isolated cells will be compared to the number of cells theoretically expected from the heterogeneous starting population. To calculate the target cell recovery, take an aliquot from the magnetically labeled fraction just before starting the cell separation.

The target cell recovery, e.g., positive cells in the magnetically labeled cell fraction can be calculated as follows:

$$\text{Target cell recovery (\%)} = 100 \times \frac{\text{No. of cells in pos. fraction} \times \% \text{ positive cells in pos. fraction}}{\text{No. of cells in orig. sample} \times \% \text{ positive cells in orig. sample}}$$

The overall cell recovery can be calculated as follows:

$$\text{Overall cell recovery (\%)} = 100 \times \frac{\text{No. of cells in pos. fraction} + \text{No. of cells in neg. fraction}}{\text{No. of cells in orig. sample}}$$

## 8.2 Purity of isolated cell population

For most experiments that follow the cell separation, it is necessary to document the purity of the isolated cell subset. It is recommended to analyze the cells by flow cytometry, e.g. the MACSQuant® Instrument. Alternatively, fluorescence microscopy or immunocytochemistry can be used.

Purity of the positively selected cell fraction:

$$\text{Purity} = \% \text{ positive cells in positive (magnetically labeled) fraction}$$

Purity of the depleted cell fraction:

$$\text{Purity} = \% \text{ negative cells in negative (non-labeled) fraction}$$

## 8.3 Viability of the cells

Different dyes are available to discriminate between live and dead cells. The most common method to discriminate between live and dead cells is based on trypan blue staining and analysis by light microscopy. Trypan blue crosses the cell membrane of dead cells and stains the cells. Live cells are not stained.

Propidium iodide (5.0 µg/mL) is most often used for flow cytometry and fluorescence microscopy. It crosses the permeable cell membrane of dead cells, enters the nucleus, and interacts with DNA. Therefore, the nucleus of dead cells is fluorescently stained.

Other fluorescent dyes, for example, DAPI [4',6-diamidino-2-phenylindole] can be used depending on the properties of the flow cytometer, i.e., its excitation wavelength capabilities, particularly in the UV range.

When working with fixed cells, it is recommended to use the Fixation and Dead Cell Discrimination Kit (#130-091-163) for both the cell fixation as well as the discrimination of dead cells.

The viability can be calculated as follows:

$$\text{Viability (\%)} = 100 \times \frac{\text{No. of live cells}}{\text{No. of total cells (live \& dead)}}$$

# 9

## Troubleshooting

If the outcome of a cell separation procedure is deemed unsatisfactory, this may either be due to incorrect function of the instrument or to inappropriate processing of the sample. This section discusses possible instrument malfunctions that may appear. In section 9.3, a list of numerically encoded errors and warning messages are presented along with user actions for troubleshooting.

### 9.1 Issues with moving hardware

If an error with moving hardware components occurs, it is recommended to run the **Check\_up** program. The program automatically analyzes the functionality of moving hardware components. A report is displayed after the analysis of each single component. Following hardware components are analyzed: dilutor valve, valves 1–4, peristaltic waste pump, magnet 1–2, needle arm (movement along the z-axis and the y-axis), and MACS MiniSampler Plus. Furthermore, the calibration data is checked.

- 1 Go to **Option > User settings > Check\_up** and press **Run**.
- 2 After each step, press **Cancel** to quit or press **OK** to continue. Possible hardware problems will be detailed on the screen.

## 9.2 Hardware issues not indicated by an error screen

### 9.2.1 Column leakage

- 1 If a freshly installed autoMACS Column shows signs of leakage, check if the column is installed properly. The column should be inserted precisely into the column connector and fastened to the point of resistance. If this is not the case, loosen the column connector, insert the column precisely, and tighten the connector again.
- 2 Run the **Qrinse** program: Go to the **Separation** menu from the upper navigation bar and press **Wash now**. Select **Qrinse** and press **Run**. Check if the leakage persists. If so, unscrew the column and check if the luer connectors of the columns are damaged. If this is the case, exchange the leaking column with a new autoMACS Column (refer to section 7.2.1).
- 3 Check if the column connector is fastened properly. If not, use second wrench to counter and tighten another quarter-turn.
- 4 If the problem persists, contact Technical Support

### 9.2.2 Tubing leakage

- 1 Identify the location of the leaky tubing by running the **Rinse** program. Press **Wash Now** from the lower menu bar in the **Separation** menu. Select **Rinse** and press **Run**.
- 2 Check whether the tubing is tightened properly. If this is not the case, tighten the tube connector. The connector should be inserted precisely.
- 3 If the problem persists, loosen the tube connector and pull back the connector from the tubing. **Do not remove the connector from the tubing.**
- 4 Check the ends of the tubing for wear and fissures. If necessary, replace tubing with the appropriate spare part. Insert the tubing into the appropriate port. Then cautiously insert and fasten the tube connector.
- 5 Run the **Rinse** program and check if the leakage persists. If so, unscrew the tubing and check if the screw thread is damaged. If this is the case, order and install new tubing. Please note that each tube has a specific length and should be exchanged with the corresponding spare part only.
- 6 If the problem persists, contact Technical Support.

### 9.2.3 Pump syringe leakage

Verify that the Running Buffer has equilibrated to room temperature before performing a washing or separation program. Cold buffer will make the plunger seal constrict more than usual and may lead to leakage. Salt crystals may also damage the pump syringe seal. To clean the pump syringe and retry. If the problem persists follow the guidelines below.

- 1 Run the **Sleep** program: Press the shutdown button, select **Yes** to shutdown the instrument.
- 2 Switch off the instrument.
- 3 Wash the pump syringe as described in section 7.2.3.
- 4 Switch on the instrument and run the **Qrinse** program to ensure that the problem is solved. Go to the **Separation** menu and press **Wash Now**. Select **Qrinse** and press **Run**.
- 5 If the leakage persists, installing either a new Pump Syringe or a new Pump Seal might be required. Contact Tech Support for assistance. For details on the installation, refer to section 7.2.3.

### 9.2.4 Pump syringe is filled with air during operation

If there is any air inlet into the pump syringe during operation, the correct proceeding of a separation will be impaired.

- Check all tubings that are connected to the fluid bottles. Make sure that all tubings are fastened properly. If a screw thread is damaged, order and install new tubing.
- Check if the hydrophobic air filters connected to the fluid bottles are clogged. Clogging may cause positive or negative pressure in the fluid bottles, which can lead to pressure problems in the fluidic system. If filters are clogged, replace them with new hydrophobic air filters (refer to section 7.2.2).
- Check if the connections and pump syringe are leaky (refer to section 7.2.3).
- Check if the uptake port needle is connected correctly and no air inlet is possible. If not, unscrew and check screw threads. If they are undamaged, reinsert precisely and fasten. Then use the wrench to turn an extra quarter-turn. Do not to overtighten the screw.
- If the problem persists, contact Technical Support.

### 9.2.5 Washing station overflow

- Verify that the washing station is not clogged with salt deposits. Take out the washing station and clean as indicated in section 7.2.4. To prevent the formation of salt deposits, wipe the outlet ports with a tissue soaked with distilled (or deionized) water before each **Sleep** program.

Reassemble washing station and run a **Rinse** program. Go to the **Separation** menu and press **Wash Now**. Select **Rinse** and press **Run**.

- If the problem persists, follow the steps below.
- Make sure that the peristaltic waste pump works properly. Run the **Check\_up** program. Go to **Option > User settings > Check\_up** and press **Run**.
- If the **Check\_up** program reports a problem with the waste pump, remove the pump head and clean the pin that drives the pump (for details, refer to section 7.3.3). Clean the washing station (refer to section 7.2.4). Reassemble the unit and check whether the problem persists.
- If the problem persists, replace the pump head (refer to section 7.3.3).

### 9.2.6 Outlet port is clogged

- Wipe the outlet port with a tissue soaked with 70% ethanol or double-distilled water.
- Flush the outlet port manually using a syringe filled with 70% ethanol or double-distilled water.

### 9.2.7 Contamination of tubing system

- To prevent contamination, run a **Sleep** program before turning off the instrument.
- Decontaminate the instrument. Refer to section 7.2.5 for details. If the problem persists, call Technical Support.

### 9.2.8 MACS MiniSampler Plus does not move properly

- Check whether the cable of the MACS MiniSampler Plus is connected properly to the connector at the autoMACS Pro Separator labeled **External CAN**.
- Check whether the bolt below the rack detection protrudes from the instrument. If this is the case, push it in and turn it clockwise to lock the bayonet mount.
- Check the cable connection between MACS MiniSampler Plus and autoMACS Pro Separator. Check for cable damages.
- Check whether the MACS MiniSampler Plus can freely move to both sides and check for any resistance or collision.
- If the problem persists, contact Technical Support.

### 9.2.9 Touchscreen remains dark

- 1 Switch off the instrument, wait five seconds, and switch on again.
- 2 If the autoMACS Pro Separator still does not initialize, check if the power cord is plugged in correctly and if the electric power is switched on.
- 3 Replace the fuses (refer to section 7.3.5). Spare fuses are included in the autoMACS Pro Separator – Starter Kit.
- 4 If the problem persists, contact Technical Support.

## 9.2.10 Disruption of power supply during cell separation

**CAUTION!** Depending on the nature of your sample it is recommended to wear protective gloves, protective clothing, and safety glasses to prevent contact with skin and eyes. Dispose tissues, swabs, and vials appropriately.

Should the separation be interrupted before target cells are eluted, it is possible to perform a cell rescue procedure to recover the sample. If the instrument can be restarted, follow Rescue procedure A; if the instrument cannot be restarted, follow Rescue procedure B.

### 9.2.10.1 Rescue procedure A

- 1 Restart the instrument by switching it off and on again.
- 2 In order to perform a cell rescue procedure, the **O\_init** program must be disabled. If initial wash (**O\_init** program) is enabled, press **Stop** as soon as the **Status** menu appears on the screen. A window opens displaying that the process is paused. Press **Cancel**.
- 3 Undo the tubing connector at the negative port and place into a 50 mL tube.
- 4 Take out the uptake port needle from the needle holder and place it into a 50 mL tube.
- 5 Undo the tubing connector of the waste tube at the waste bottle and place it into a 50 mL tube; place a second 50mL tube beside this one.
- 6 Run the program **Qrinse**. This will rinse the complete fluidic system with autoMACS Pro Running Buffer eluting the cells into the 50 mL tubes. Depending on which step of the separation program that the interruption occurred, the cells will be found in any one of the vials.
- 7 Combine all fractions and centrifuge at 350×g for 10 minutes.
- 8 Discard the supernatant and apply cells to a re-separation as soon as possible. Keep cells on ice until the separation.
- 9 Reconnect all tubing at the appropriate positions and reposition up-take needle in needle holder

### 9.2.10.2 Rescue procedure B

If it is not possible to restart the instrument the cells retained on the columns can be recovered as follows:

- 1 Switch off the instrument using the main power switch and disconnect the instrument from the power supply.



- 2 Prepare two 50 mL tubes in a rack and fill two 5 mL syringes with Running Buffer/Separation Buffer.
- 3 Open the front cover and place absorbent tissue underneath the columns.
- 4 Pull out the column from the column holder and replace the top connector with a 5 mL syringe filled with Running Buffer.
- 5 Undo the bottom connector and flush the column into a 50 mL tube. Discard column and syringe appropriately.
- 6 Repeat steps 4 to 5 with the second column.
- 7 Centrifuge tubes at 350×g for 10 minutes.
- 8 Discard the supernatant and perform reseparation on the recovered cells as soon as possible. Keep cells on ice until the separation.
- 9 Install new columns or column substitutes in place of the discarded ones.

### 9.3 Hardware issues indicated by an error screen

If errors or warnings are displayed on the screen of the instrument, please refer to the following table. If the below measures do not clear the fault, contact Miltenyi Biotec Technical Support. To assist in the troubleshooting process, please have the instrument serial number and details of the error message at hand, i.e., error number, module number, file, and error line. If this is not possible, please go to the instrument log list and view the log list details taking care to note the displayed parameters exactly. To discuss the table below, please contact Technical Support.

Error code	Cause	Possible remedies
-5	Hardware module is not initialized. After a module malfunction an initialization of the module is necessary. This might also be a subsequent error if another error has been displayed shortly before.	Restart instrument. Please call Technical Support if error is displayed again.
-27	Standard valve initialization failed. Valve may be blocked or worn and cannot be turned correctly or valve drive is damaged.	Switch off the instrument, wait for 5 seconds, and switch the instrument ON again. If error persists, press the button <b>Details</b> . Exchange displayed valve. If error is displayed again call Technical Support.
-28	Motor rotation detection failed. Valve may be blocked or worn and cannot be turned correctly. Otherwise valve or magnet drive malfunction.	Press the <b>Details</b> button. Exchange displayed valve if applicable. If error is displayed again or magnet is displayed call Technical Support.

-29	Valve rotation hindered. Valve may be blocked or worn and cannot be turned correctly.	Switch off the instrument, wait 5 seconds and turn it on again. If error persists, switch off instrument, loosen air filters on buffer/waste bottles by a half turn, exchange columns for dummy columns, verify that washing station is free of clogs and salt deposits (clean washing station), verify that uptake needle is not clogged. Switch on instrument, if error persists, press <b>Details</b> . Exchange displayed valve if applicable. Make sure to prepare samples as specified. If error is displayed again call Technical Support.
-257	Needle arm movement has been hindered.	If object blocked movement, remove object. Switch off instrument. Wait 5 seconds. Switch on instrument. Otherwise or if error is displayed again call Technical Support.
-263	Unable to read rack bar code correctly.	Check bar code on rack or try different rack. Make sure ambient or direct sun light does not hit sensor. Clean sensor to remove salt or dust using a cloth soaked in 70% ethanol or double distilled water and wipe dry.
-264	Unable to read rack bar code correctly.	Check bar code on rack or try different rack. Make sure ambient or direct sun light does not hit sensor.
-769	Diluter plunger could not be initialized. Syringe not mounted correctly, syringe damaged, or diluter valve not positioned correctly.	Check if syringe is fastened correctly. Exchange if broken or damaged. If error is displayed again call Technical Support.
-775	Diluter is not initialized. After a diluter malfunction an initialization of the module is necessary. This might also be a subsequent error if another error has been displayed shortly before.	Restart instrument. Please call Technical Support if error is displayed again.
-777	Plunger movement blocked because of column clogging, blocked tubing set, or any other cross-section constriction.	Restart instrument and try a <b>Qrinse</b> to wash out clogged material. If error persists run the <b>Safe</b> program. Otherwise exchange diluter valve or standard valves depending on where a constriction is suspected. Please call Technical Support if error is displayed again.
-6006	Air intake during sample uptake although needle did not yet hit bottom of tube. Leakage of air into system in front of bubble sensor, liquid level has been overestimated, or needle did not move to bottom (as fast as necessary).	Make sure foam on top of sample is not higher than 5 mm above liquid level. Verify that sample was filtered before separation and that uptake needle is not clogged. Check for leakage at the point where the needle and tubing meet, and where the tubing to bubble sensor meet. Verify that connectors are appropriately fastened.

-6009	Unexpected air in system during sample uptake.	Check for leakage or air bubbles in tubing from uptake needle to valve 1. Verify that connectors are appropriately fastened. Calibrate needle arm. Check for buffer supply. Otherwise call Technical Support.
-6216	The reagent designated for the current labeling process is not assigned a position in the Reagent Rack.	Provide all necessary reagents in Reagent Rack and correct Reagent Rack definition.
-7001	Needle could not be retreated completely.	Try reinitialization by touching <b>Retry</b> . Otherwise call Technical Support.
-7002	Collision of the needle with the bottom of the tube (or any other object) has been detected, but resetting the collision sensor failed although the needle has been lifted.	Push back needle to it's proper position in the needle holder, check for smooth running of the needle in its support then touch <b>Continue</b> . Otherwise calibrate needle arm, especially if using a Chill 15 Rack.
-7003	Collision of the needle with an unexpected object. Resetting the collision sensor failed as the needle could not be lifted (already too close to top).	Check for objects hindering the movement of the needle. Remove the uptake needle from the needle holder and verify that there are no physical obstructions. Press <b>Continue</b> .
-7004	Collision of the needle with an unexpected object far above expected tube bottom.	Check that cover of the washing station is properly closed. Remove any objects hindering the movement of the needle. If needle hits rim of tube or top of rack calibrate needle arm using <b>Calibr_1</b> program. Press <b>Lift</b> for needle retreat.
-7005	Collision of the needle with an unexpected object far above expected tube bottom.	Check that cover of the washing station is properly closed. Remove any objects hindering the movement of the needle. If needle hits rim of tube or top of rack, calibrate needle arm. Press <b>Retry</b> to try again.
-7006	Collision of the needle with an unexpected object far above expected tube bottom.	Check that cover of the washing station is properly closed. Remove any objects hindering the movement of the needle. If needle hits rim of tube or top of rack, calibrate needle arm. Touch <b>Retry</b> to try again.
-7007	Sample volume exceeds maximum volume specified for rack or program type. Remaining portion of sample will not be processed.	Do not use sample volumes exceeding the maximum volume specified for rack or program type. If volumes are in specified range but error is displayed anyway, please call Technical Support.
-7008	The sample volume has been underestimated. The needle has been rinsed but might still be contaminated.	Please clean outside of needle manually. If this error is displayed frequently, please call Technical Support.
-7009	Collision of needle with bottom of tube could not be detected at expected position.	Check if tubes are correctly positioned in rack corresponding to template programming. Check MACS MiniSampler Plus connection in front of autoMACS Pro Separator.

-7010	Not certain if liquid surface of sample has been detected correctly.	Press <b>Ignore</b> to continue without liquid detection. Needle will be moved to bottom directly. This might result in a subsequent warning -7008 if the liquid level is higher than 60 mm above the tube bottom (see above). Press <b>Retry</b> to continue with liquid detection. Ensure that the tubing from the needle arm to bubble sensor can move freely. Adjust the tubing if necessary. Otherwise call Technical Support.
-7011	Restart of the instrument is required.	Please restart instrument.
-7012	Calibration data not found.	Please calibrate needle arm axes. Run program <b>Calibr_1</b> .
-7013	Calibration data not found.	Please calibrate needle arm axes. Run program <b>Calibr_1</b> .
-7014	Calibration data not found.	Please calibrate tubing. Run program <b>Calibr_2</b> .
-7015	Columns are not installed.	Please install columns.
-7018	Calibration data not found.	Please calibrate MACS MiniSampler Plus using program <b>Calibr_1</b> .
-7021	A separation program has been started but system had not been rinsed properly.	Please rinse system by selecting <b>Wash</b> , or abort with <b>Cancel</b> .
-7022	Columns are overdue.	Please install new columns. Touch <b>Cancel</b> to abort and then install columns, touch <b>Continue</b> to ignore and use old columns (not recommended).
-7023	Plunger movement blocked because of column clogging, blocked tubing set or any other cross-section constriction during output of the negative fraction. The negative fraction has not been eluted completely. Negative cells are still remaining in the system.	Touch <b>Cont</b> to discard the remaining negative cells into the waste bottle. To output negative fraction again at lower speed, exchange negative tube with an empty tube and touch <b>Retry</b> .
-7024	The number of programmed sample positions exceeds the actual positions of the rack on the MACS MiniSampler Plus.	Exchange rack with rack holding more samples and touch <b>OK</b> or touch <b>Cancel</b> to abort and reprogram.
-7026	The protective cover of the MACS MiniSampler Plus seems to be opened by the moving needle arm hitting the cover.	Check configuration and connection of the protective cover, the MACS MiniSampler Plus, and the front support at the autoMACS Pro Separator then touch <b>Continue</b> . Touch <b>Cancel</b> to abort.
-7027	The protective cover of the MACS MiniSampler Plus needs to be closed.	Please close protective cover and touch <b>Continue</b> . Touch <b>Cancel</b> to abort.
-7028	Bar code on Chill Rack could not be read. MACS MiniSampler Plus is not connected (properly).	Check electrical connection of MACS MiniSampler Plus. If detected the MACS MiniSampler Plus symbol would be displayed in the status screen.
-7029	Unable to read rack bar code correctly	Check bar code on rack or try different rack. Make sure ambient or direct sun light does not hit sensor. Touch <b>Retry</b> to try again, touch <b>Select</b> to set Chill Rack type without automatic bare code reading.

-7030	The instrument has been shut down without using "Sleep".	Always use <b>Sleep</b> to shut down the instrument.
-7031	The given whole blood sample size exceeds the maximum volume specified. The sample cannot be diluted sufficiently.	Do not use sample volumes exceeding the maximum whole blood sample volume specified for the used Chill Rack type. Split sample into several tubes, reprogram separation parameters, and restart separation. If volumes are in specified range but error is displayed anyway, please call Technical Support.
-7032	Air in system during calibration of tubing.	Check buffer supply. Check for leakage of system (unintended air intake). Start a rinse program ( <b>Wash only</b> ) and then retry calibration. Otherwise call Technical Support.
-7033	Date and time is outdated.	Set time and date to actual values.
-7035	Air intake during sample uptake although needle did not yet hit bottom of tube. Leakage of air into system in front of bubble sensor, liquid level has been overestimated, or needle did not move to bottom (as fast as necessary). Uptaken sample has been processed. Portion of sample is remaining in tube.	Make sure foam on top of sample is not higher than 5 mm above liquid level. Check for leakage at transition of needle to tubing and tubing to bubble sensor.
-7036	Plunger movement blocked because of column clogging, blocked tubing set, or any other cross-section constriction during output of the positive fraction. The positive fraction has not been eluted completely. Positive cells are still remaining in the system.	Touch <b>Cont</b> to discard the remaining positive cells into the waste bottle. To output positive fraction again at lower speed, exchange positive tube with an empty tube and touch <b>Retry</b> .
-7038	Resuspended sample could not be taken up completely (no final air intake detected). Leakage of air into system behind bubble sensor. Portion of resuspended cells are remaining in tube.	Check for leakage of air into system behind bubble sensor. Readjust tubing connectors and verify correct fastening of columns.
-7039	Required volume cannot be provided in given Chill Rack.	Exchange rack with rack able to provide requested volume (e. g. Chill 50 instead of Chill 15). Touch <b>Retry</b> to try again. Touch <b>Cancel</b> to abort.
-7048	Miscalculation of diluter movement. Target position is negative.	Touch <b>Retry</b> to use target position 0 instead of negative value for current diluter move. Touch <b>Cancel</b> to abort. Please contact the Technical Support in all cases – also if the sample has been processed completely after touching <b>Retry</b> .

**Table 9.1:** Error codes and possible remedies.

# 10

## Technical data and specifications

### 10.1 Technical data and specifications

**WARNING!** Read the chapter **Important safety information** before installation and use.

The autoMACS Pro Separator is labeled as a protection class I instrument and must be plugged into a grounded power outlet. The MACS MiniSampler Plus is labeled as a protection class III instrument and must only be plugged into the connector labeled with External CAN of the autoMACS Pro Separator.

The main power supply cord and plug of the instrument shall comply with following specifications (USA and Canada only): UL listed and KAM cord, minimum type SJ, minimum 18 AWG, 3 conductors. Rated for a minimum temperature of 60 °C. Provided with grounding-type (NEMA 5-15P) attachment plug, rated 125 Vac, 10 A. Opposite end terminates in IEC 320 style connector, rated 125 Vac, 10 A.

Supply voltage fluctuations up to +/-10% of the nominal voltage. Transient overvoltages present on the mains supply: category II. The instrument is suitable for rated pollution degree 2.

Technical data	
Model	autoMACS Pro Separator
Dimension (WxD)*	605 mm × 343 mm
Dimension with MACS MiniSampler Plus (WxD)*	605 mm × 455 mm
Height	392.5–454 mm (adjustable touchscreen)
Weight	25 kg
Input voltage	100–240 V~, 50/60 Hz
Maximum power rating	100 W
Average power rating	40 W
Fuses	2×T4A/250 V
Programs	12 preset
Sample volume (input)	0.25–50 mL
Sample volume (output)	0.5–52 mL
Column capacity	4×10 <sup>9</sup> cells/sample 2×10 <sup>8</sup> magnetically labeled cells/sample 15 mL of whole blood
RS232-Interface (labeled <b>COM</b> )	Pins 1, 4, 6, 9: NC Pin 2: RXD Pin 3: TXD Pin 5: GND Pin 7: RTS Pin 8: CTS
RS232-Interface (labeled <b>RS232/AUX</b> ) Not in use	Pins 1, 4, 6, 7, 8, 9: NC Pin 2: RXD Pin 3: TXD Pin 5: GND
RS232-Interface + DC-Output (labeled <b>RS232/BCR</b> )	Pins 4, 6: NC Pin 1: Input Pin 2: RXD Pin 3: TXD Pin 5: GND Pins 7, 8: Shorted Pin 9: 5 VDC/0.5 A
CAN-Bus + DC-Output (labeled <b>External CAN</b> )	Pins 1, 4, 8: NC Pin 2: CAN-L Pins 3, 6: GND Pins 5, 9: 24 VDC/2A Pin 7: CAN-H
AC-Output (labeled <b>Bottle Sensor</b> )	Pins 1, 2, 3, 4, 5: 5 VAC/10 kΩ Pins 6, 7, 8, 14, 15: GND Pins 9, 10, 11, 12, 13: Input
CAN-Bus (labeled <b>CAN1</b> or <b>CAN2</b> )	Pins 1, 4, 5, 8, 9: NC Pin 2: CAN-L Pins 3, 6: GND Pin 7: CAN-H

Technical data	
<b>Model</b>	<b>autoMACS Pro Separator</b>
Working temperature	15–30 °C The autoMACS Pro Separator is not specified for use in a cold room.
Humidity	0%–85% relative humidity, non condensing
Altitude	max. 2000 m
Emission sound pressure level at workstation	<70 dB(A)

\*Depending on the type of power plug, the depth increases by 27 mm or 62 mm.

**Table 10.1:** Technical data of the autoMACS Pro Separator.

Technical data	
<b>Model</b>	<b>MACS MiniSampler Plus</b>
Dimension without lid (WxDxH)	182 mm × 127 mm × 47 mm
Dimension with lid (WxDxH)	280 mm × 131 mm × 172 mm
Weight	1.5 kg
Power requirements	24 V 
Electric current	0.8 A
Maximum power rating	19.2 W
Sub D9 interface with shielding	Pins 1, 4, 8: NC Pin 2: CAN-L Pins 3, 6: GND Pins 5, 9: 24 VDC/2A Pin 7: CAN-H
Working temperature	refer to technical data of the main instrument in table 10.1
Humidity	refer to technical data of the main instrument in table 10.1
Altitude	refer to technical data of the main instrument in table 10.1
Emission sound pressure level at workstation	refer to technical data of the main instrument in table 10.1

**Table 10.2:** Technical data of the MACS MiniSampler Plus.



## 10.2 Compliance with FCC rules

This equipment has been tested and found to comply with the limits for a Class B digital device, pursuant to Part 15 of the FCC Rules. These limits are designed to provide reasonable protection against harmful interference in a residential installation. This equipment generates, uses, and can radiate radio frequency energy and, if not installed and used in accordance with the instructions, may cause harmful interference to radio communications. However, there is no guarantee that interference will not occur in a particular installation. If this equipment does cause harmful interference to radio or television reception, which can be determined by turning the equipment off and on, the user is encouraged to try to correct the interference by one or more of the following measures:

- Reorient or relocate the receiving antenna.
- Increase the separation between the equipment and receiver.
- Connect the equipment into an outlet on a circuit different from that to which the receiver is connected.
- Consult the dealer or an experienced radio/TV technician for help.

Changes or modifications of the equipment unless expressly approved by Miltenyi Biotec may void your authority to operate the equipment pursuant to FCC 47 CFR.

## 10.3 EC declaration of conformity (autoMACS® Pro Separator)

This declaration of conformity is issued under the sole responsibility of the manufacturer:

Miltenyi Biotec B.V. & Co. KG  
Friedrich-Ebert-Str. 68  
51429 Bergisch Gladbach  
Germany

This declaration relates exclusively to the machinery in the state in which it was placed on the market, and excludes components which are added and/or operations carried out subsequently by the final user.

The declaration of conformity refers to the machinery identified as follows:

Description:	Laboratory equipment
Model:	autoMACS® Pro Separator

The machinery complies with all essential requirements of the following directives:

2006/42/EC Machinery  
2011/65/EU Restriction of the use of certain hazardous substances  
in electrical & electronic equipment  
2014/30/EU Electromagnetic compatibility

The machinery is in conformity with the following harmonized standards:

EN 60825-1:2014  
EN 61010-1:2010  
EN 61010-2-081:2015  
EN 61326-1:2013

Person authorized to compile the relevant technical documentation:

Stefan Miltenyi  
Miltenyi Biotec B.V. & Co. KG  
Friedrich-Ebert-Str. 68  
51429 Bergisch Gladbach  
Germany

## 10.4 EC declaration of conformity (MACS® MiniSampler Plus)

This declaration of conformity is issued under the sole responsibility of the manufacturer:

Miltenyi Biotec B.V. & Co. KG  
Friedrich-Ebert-Str. 68  
51429 Bergisch Gladbach  
Germany

This declaration relates exclusively to the machinery in the state in which it was placed on the market, and excludes components which are added and/or operations carried out subsequently by the final user.

The declaration of conformity refers to the machinery identified as follows:

Description:	Laboratory equipment
Model:	MACS® MiniSampler Plus

The machinery complies with all essential requirements of the following directives:

2006/42/EC Machinery  
2011/65/EU Restriction of the use of certain hazardous substances  
in electrical & electronic equipment  
2014/30/EU Electromagnetic compatibility

The machinery is in conformity with the following harmonized standards:

EN 61010-1:2010  
EN 61010-2-081:2015  
EN 61326-1:2013

Person authorized to compile the relevant technical documentation:

Stefan Miltenyi  
Miltenyi Biotec B.V. & Co. KG  
Friedrich-Ebert-Str. 68  
51429 Bergisch Gladbach  
Germany

For other safety considerations, refer to the product label or visit  
**[www.miltenyibiotec.com](http://www.miltenyibiotec.com)**

Design and specifications are subject to change without notice.

# 11

## Technical support

For technical support, please contact your local Miltenyi Biotec representative or the Technical Support team at Miltenyi Biotec headquarters:

**Miltenyi Biotec B.V. & Co. KG**

Friedrich-Ebert-Straße 68  
51429 Bergisch Gladbach  
Germany  
Phone +49 2204 8306-830  
Fax +49 2204 8306-89  
macstec@miltenyi.com

Visit **[www.miltenyibiotec.com/local](http://www.miltenyibiotec.com/local)**  
to find your nearest Miltenyi Biotec contact.



# 12

## Limited warranty

Except as stated in a specific warranty statement which may accompany this product or as otherwise agreed in writing by an authorized representative of Miltenyi Biotec, Miltenyi Biotec's warranty to you, the original purchaser and end user ("you" or "your"), with respect to the product accompanied by this limited warranty shall be subject to the following provisions and the general terms and conditions of sale of the company within the Miltenyi Biotec group which supplied the product in effect at the date of purchase. Those terms and conditions of sale may vary by country and region. Nothing in this document should be construed as constituting an additional warranty.

Miltenyi Biotec warrants that this product will operate or perform substantially in conformance with Miltenyi Biotec's published specifications and be free from material defects in material and workmanship, when subjected to normal, proper and intended usage by properly trained personnel, for the period of time set forth in the product documentation or package inserts accompanying the product (the "Warranty Period").

Miltenyi Biotec agrees, during the Warranty Period, to repair or replace, at Miltenyi Biotec's option, the defective product so as to cause the same to operate in substantial conformance with said published specifications; provided that you shall (a) promptly notify Miltenyi Biotec in writing upon the discovery of any nonconformity or defect, which notice shall include the product model and serial number (if applicable) and details of the warranty claim; and (b) return the nonconforming or defective product to Miltenyi Biotec, freight prepaid, only after receipt of a Return Material Authorization ("RMA") from Miltenyi Biotec, which may include biohazard decontamination procedures and other product-specific handling instructions, if applicable.

Miltenyi Biotec shall have no obligation to make repairs, replacements or corrections to the product or any component thereof required, in whole or in part,

as the result of (i) normal wear and tear, (ii) improper handling, installation, operation, storage, service, maintenance or repair, (iii) failure to follow the instructions, cautions, warnings, and notes set forth in the product documentation provided with the product or provided by Miltenyi Biotec from time to time, (iv) abnormal use, misuse, neglect, abuse, mishandling, misapplication, modification or alteration of the product, (v) use of the product in a manner for which it was not designed, (vi) causes external to the product such as, but not limited to, power failure or electrical power surges, (vii) use of the product in combination with equipment, accessories, consumables or software not supplied or approved by Miltenyi Biotec, or (viii) accident, disaster or acts of God. ANY INSTALLATION, MAINTENANCE, REPAIR, SERVICE OR ALTERATION TO OR OF, OR OTHER TAMPERING WITH, THE PRODUCT PERFORMED BY ANY PERSON OR ENTITY OTHER THAN MILTENYI BIOTEC AUTHORIZED PERSONNEL WITHOUT MILTENYI BIOTEC'S PRIOR WRITTEN APPROVAL, OR ANY USE OF REPLACEMENT PARTS NOT SUPPLIED BY MILTENYI BIOTEC, SHALL IMMEDIATELY VOID AND CANCEL ALL WARRANTIES WITH RESPECT TO THE AFFECTED PRODUCT.

Miltenyi Biotec's warranty does not cover products sold AS IS or WITH ALL FAULTS, or which had its serial number defaced, altered or removed, or any consumables, or parts identified as being supplied by a third party.

Miltenyi Biotec must be informed promptly if a claim is made under this limited warranty. If a material or manufacturing defect occurs within the Warranty Period, Miltenyi Biotec will take the appropriate steps, at Miltenyi Biotec's option, to make repairs, replacements or corrections to the product or any component thereof as may be required to restore the full usability of your product. If Miltenyi Biotec determines that a product for which you have requested warranty services is not covered by the warranty hereunder, you shall pay or reimburse Miltenyi Biotec for all costs of investigating and responding to such request at Miltenyi Biotec's then prevailing time and materials rates. If Miltenyi Biotec provides repair services or replacement parts that are not covered by this warranty, you shall pay Miltenyi Biotec therefor at Miltenyi Biotec's then prevailing time and materials rates.

THE OBLIGATIONS CREATED BY THIS WARRANTY STATEMENT TO REPAIR OR REPLACE A DEFECTIVE PRODUCT ARE EXCLUSIVE AND SHALL BE THE SOLE REMEDY OF BUYER IN THE EVENT OF A DEFECTIVE PRODUCT. EXCEPT AS EXPRESSLY PROVIDED IN THIS WARRANTY STATEMENT, MILTENYI BIOTEC HEREBY DISCLAIMS ALL OTHER WARRANTIES, WHETHER EXPRESS OR IMPLIED, ORAL OR WRITTEN, WITH RESPECT TO THE PRODUCT, INCLUDING WITHOUT LIMITATION ALL IMPLIED WARRANTIES OF MERCHANTABILITY OR FITNESS FOR ANY PARTICULAR PURPOSE. MILTENYI BIOTEC DOES NOT WARRANT THAT THE PRODUCT IS ERROR-FREE OR WILL ACCOMPLISH ANY PARTICULAR RESULT.

UNDER NO CIRCUMSTANCES WILL MILTENYI BIOTEC BE LIABLE FOR ANY LOSS OF USE, INTERRUPTION OF BUSINESS OR ANY INDIRECT, SPECIAL, INCIDENTAL,

PUNITIVE OR CONSEQUENTIAL DAMAGES OF ANY KIND (INCLUDING LOST PROFITS) REGARDLESS OF THE FORM OF ACTION WHETHER IN CONTRACT, TORT (INCLUDING NEGLIGENCE), STRICT PRODUCT LIABILITY OR OTHERWISE, EVEN IF MILTENYI BIOTEC HAS BEEN ADVISED OF THE POSSIBILITY OF SUCH DAMAGES. IN NO EVENT SHALL THE TOTAL LIABILITY OF MILTENYI BIOTEC HEREUNDER EXCEED THE GREATER OF 100.00 EUROS OR THE AMOUNT YOU ACTUALLY PAID FOR THE PRODUCT GIVING RISE TO SUCH LIABILITY, REGARDLESS OF THE CAUSE OF ACTION, IN CONTRACT, TORT, STRICT LIABILITY OR OTHERWISE.

NOT ALL JURISDICTIONS ALLOW SUCH LIMITATIONS OF DAMAGES SO THE FOREGOING LIMITATIONS MAY NOT APPLY TO YOU. This warranty statement gives you specific legal rights and you may have other rights, which may vary from jurisdiction to jurisdiction.





**Miltenyi Biotec**

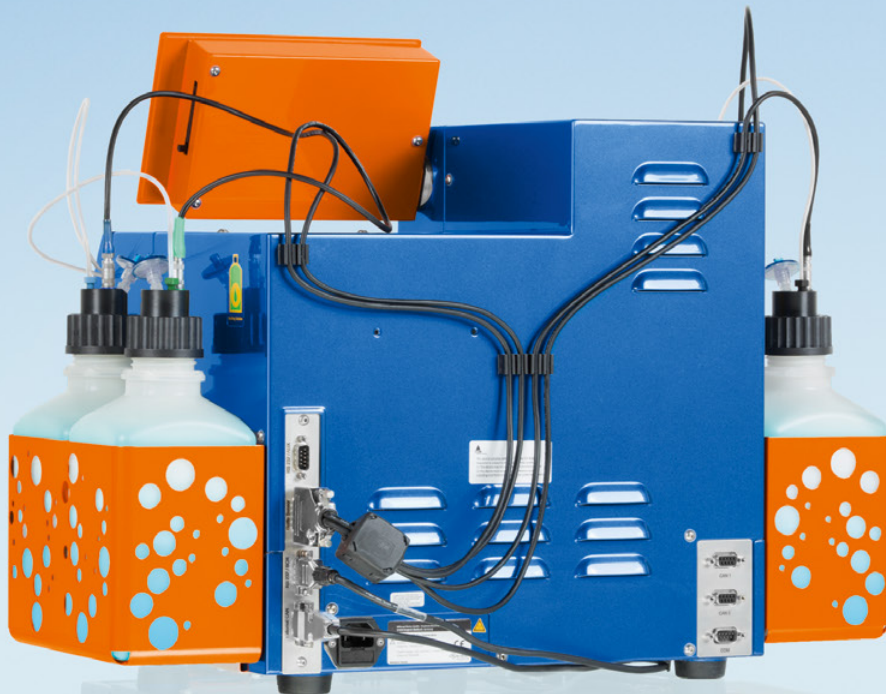

**Germany/Austria**

Miltenyi Biotec B.V. & Co. KG  
Friedrich-Ebert-Straße 68  
51429 Bergisch Gladbach  
Germany  
Phone +49 2204 8306-0  
Fax +49 2204 85197  
macsde@miltenyi.com

**USA/Canada**

Miltenyi Biotec Inc.  
2303 Lindbergh Street  
Auburn, CA 95602, USA  
Phone 800 FOR MACS  
Phone +1 530 888 8871  
Fax +1 877 591 1060  
macsus@miltenyi.com

**Australia**

Miltenyi Biotec  
Australia Pty. Ltd.  
Unit 11, 2 Eden Park Drive  
Macquarie Park, NSW 2113  
Australia  
Phone +61 2 8877 7400  
Fax +61 2 9889 5044  
macsau@miltenyi.com

**Benelux**

Miltenyi Biotec B.V.  
Sandfortdreef 17  
2333 ZZ Leiden  
The Netherlands  
macsnl@miltenyi.com

**Customer service**

**The Netherlands**

Phone 0800 4020120  
Fax 0800 4020100

**Customer service Belgium**

Phone 0800 94016  
Fax 0800 99626

**Customer service Luxembourg**

Phone 800 24971  
Fax 800 24984

**China**

Miltenyi Biotec Technology &  
Trading (Shanghai) Co., Ltd.  
Room 401  
No. 1077, Zhangheng Road  
Pudong New Area  
201203 Shanghai, P.R. China  
Phone +86 21 6235 1005  
Fax +86 21 6235 0953  
macscn@miltenyi.com

**France**

Miltenyi Biotec SAS  
10 rue Mercoeur  
75011 Paris, France  
Phone +33 1 56 98 16 16  
Fax +33 1 56 98 16 17  
macsfr@miltenyi.com

**Italy**

Miltenyi Biotec S.r.l.  
Via Paolo Nanni Costa, 30  
40133 Bologna  
Italy  
Phone +39 051 6 460 411  
Fax +39 051 6 460 499  
macsit@miltenyi.com

**Japan**

Miltenyi Biotec K.K.  
NEX-Eitai Building 5F  
16-10 Fuyuki, Koto-ku  
Tokyo 135-0041, Japan  
Phone +81 3 5646 8910  
Fax +81 3 5646 8911  
macsjp@miltenyi.com

**Nordics and Baltics**

Miltenyi Biotec Norden AB  
Scheelevägen 17  
223 70 Lund  
Sweden  
macsse@miltenyi.com

**Customer service Sweden**

Phone 0200 111 800  
Fax 046 280 72 99

**Customer service Denmark**

Phone 80 20 30 10  
Fax +46 46 280 72 99

**Customer service  
Norway, Finland, Iceland,  
and Baltic countries**

Phone +46 46 280 72 80  
Fax +46 46 280 72 99

**Singapore**

Miltenyi Biotec Asia Pacific Pte Ltd  
438B Alexandra Road, Block B  
Alexandra Technopark  
#06-01  
Singapore 119968  
Phone +65 6238 8183  
Fax +65 6238 0302  
macssg@miltenyi.com

**South Korea**

Miltenyi Biotec Korea Co., Ltd.  
Arigi Bldg. 8F  
562 Nonhyeon-ro  
Gangnam-gu  
Seoul 06136, South Korea  
Phone +82 2 555 1988  
Fax +82 2 555 8890  
macskr@miltenyi.com

**Spain**

Miltenyi Biotec S.L.  
C/Luis Buñuel 2  
Ciudad de la Imagen  
28223 Pozuelo de Alarcón (Madrid)  
Spain  
Phone +34 91 512 12 90  
Fax +34 91 512 12 91  
macses@miltenyi.com

**Switzerland**

Miltenyi Biotec Swiss AG  
Gibelinstrasse 27  
4500 Solothurn  
Switzerland  
Phone +41 32 623 08 47  
Fax +49 2204 85197  
macsch@miltenyi.com

**United Kingdom**

Miltenyi Biotec Ltd.  
Almac House, Church Lane  
Bisley, Surrey GU24 9DR, UK  
Phone +44 1483 799 800  
Fax +44 1483 799 811  
macsuk@miltenyi.com

**www.miltenyibiotec.com**

Miltenyi Biotec provides products and services worldwide. Visit [www.miltenyibiotec.com/local](http://www.miltenyibiotec.com/local) to find your nearest Miltenyi Biotec contact.

Unless otherwise specifically indicated, Miltenyi Biotec products and services are for research use only and not for therapeutic or diagnostic use. autoMACS, MACS, and the Miltenyi Biotec logo are registered trademarks or trademarks of Miltenyi Biotec and/or its affiliates in various countries worldwide. Copyright © 2020 Miltenyi Biotec and/or its affiliates. All rights reserved.